



RACE PREPARATION AND TUNING MANUAL

www.legends-yamaha-enduros.com

USE THIS MANUAL TOGETHER WITH
THE OWNER'S SERVICE MANUAL

FOREWORD

Everybody desires that his machine runs faster, but his desire can be met only when the machine is perfectly adjusted to the condition of the course.

The riding skills vary from rider to rider, and the type of course that he likes is not the same as other riders. Also, the machine setting must be changed depending on weather conditions or track conditions.

It is impossible to run your machine faster without adjusting the engine and suspension so that they completely match these varying conditions.

The YZ and IT series machines can freely be adjusted to the performance that the rider wants to achieve considering varying conditions. This possibility is one of the outstanding features of these machines.

Adjusting the machine to your preference is a trial-and-error process. You must first ride the machine, decide what problems exist, adjust the machine, and ride it again to see what you have accomplished. By doing this process patiently and methodically, you can adjust the machine to your satisfaction.

This manual provides the technical information relating to the setting and tuning up of the machine in order to bring it into full play.

CAUTION:

This manual covers all of the YZ and IT series machines, and it should be noted that part of the specifications, descriptions and photos given in the manual are subject to change without notice. Before using this manual, be sure to read the Owner's Service Manual thoroughly for further information. On some models, the description given here may differ from the actual machine. Refer to the Owner's Service Manual.

YZ and IT series
RACE PREPARATION AND TUNING MANUAL
©1983 by Yamaha Motor Corporation, U.S.A.
2nd edition, June 1983
All rights reserved. Any reprinting or
unauthorized use without the written
permission of Yamaha Motor Corporation
U.S.A., is expressly prohibited.
Printed in JAPAN
P/L LIT-11616-04-43

INDEX

RACE PREPARATION	1
Fuel	1
Engine mixing oil	1
Transmission oil	1
Coolant	2
Air filter service	2
Break-in	3
Securing handlebar	3
Rear sprocket bolt tightening	4
Spokes	4
Drive chain	4
Lubrication	5
Preoperation checks	6
CARBURETOR TUNING	7
Some basics	7
Symptoms of improper settings	8
Making setting changes	8
Main jet	9
Jet needle and needle jet	9
Slide	10
Pilot jet and pilot air screw	10
Examples	11
SPARK PLUG	12
Spark plug reading	12
Spark gap	13
Tightening torque	13
Heat range	14
Spark plug heat range comparison	14
GEARING	15
Selection of the secondary reduction ratio (sprocket)	15

SUSPENSION TUNING	16
INTRODUCTION	16
FRONT FORK	17
Fork oil level	17
Oil level adjustment	17
Fork oil weight	18
Fork spring	18
Air pressure	18
Fork clamp position	19
REAR SHOCK (MONOCROSS SUSPENSION "DE CARBON" SYSTEM)	20
Spring preload	20
Spring replacement	20
Rebound damping	21
Compression damping	21
Gas pressure	22
TIRE PRESSURE ADJUSTMENT	22
TROUBLESHOOTING IMPROPER SETTINGS	23
Symptoms of the front forks	23
Symptoms of the rear shock	23
Determining the proper settings	23
Readjustment of the suspension	24
Front and rear compatibility	24
General symptoms and remedy	25
SETTING RECORD TABLE	27

RACE PREPARATION

Fuel

Recommended fuel:
Use premium gasoline
(Octane rating is at least 90.)

Always use fresh, namebrand gasoline, and mix the oil and gas the day of the race.

NOTE:

Sometimes the properties of gasoline (octane rating, additives, etc.) affect engine performance. For instance, a low-octane gasoline leads, in some cases, to knocking or detonation under acceleration or heavy load. It is advisable, therefore, to use a high-octane gasoline premium. If you have further questions about fuel, see your Yamaha dealer.

Engine mixing oil

Oil must be mixed with the gasoline to lubricate the piston, cylinder, crankshaft bearings, and connecting rod bearings.

NOTE:

Refer to your owner's service manual for further informations.

Recommended oil: Yamalube "R"
(Yamalube Racing 2-cycle oil)
Mixing ratio: 24 : 1

If for any reason you should use another type, select from the following list.

Recommended oil	Mixing ratio
Castrol R30, A747, TTS (A545)	20 : 1

CAUTION:

Never mix two types of oil in the same batch; clotting of the oil could result. If you wish to change oil types, be sure to drain the fuel tank and the carburetor float bowl of old premix prior to filling with the new type.

To make an oil-gasoline mixture, pour oil and half of the gasoline into a container first and stir the mixture thoroughly. Then add the rest of the gasoline and stir the mixture well.

NOTE:

At a low temperature, oil will not easily mix with gasoline and therefore, take time to make a well-blended mixture.

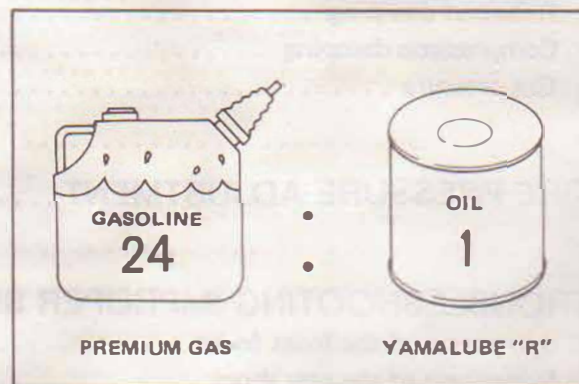

24 : 1 Premix gas chart

Gasoline	Oil
0.5 L (0.13 USgal)	21 cm ³ (0.7 USoz)
1 L (0.26 USgal)	42 cm ³ (1.4 USoz)
3 L (0.80 USgal)	125 cm ³ (4.2 USoz)
5 L (1.32 USgal)	208 cm ³ (7.0 USoz)
7 L (1.85 USgal)	290 cm ³ (9.8 USoz)
10 L (2.6 USgal)	416 cm ³ (14.1 USoz)

Transmission oil

To assure proper lubrication of the transmission, clutch, and primary gears, the transmission oil should be changed after every fifth race.

Recommended oil:
Yamalube 4-cycle oil
or
SAE 10W/30 type SE motor oil

Coolant (For water cooled engine)

WARNING:

Do not remove the radiator cap, when the engine and radiator are hot.

Check the coolant level in the radiator when the engine is cold. If the coolant level is low, add coolant.

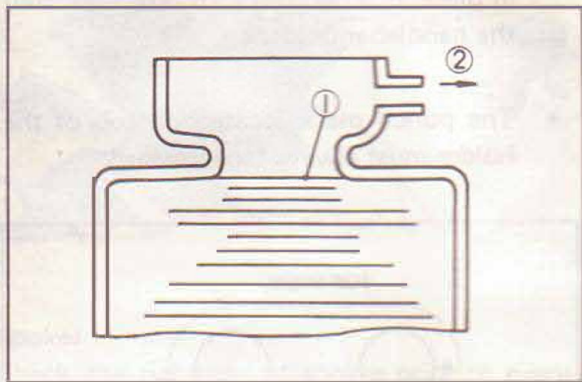

1. Coolant level 2. Breather pipe

Recommended coolant:

High quality ethylene glycol anti-freeze containing corrosion inhibitors for aluminum engine

Coolant and water mixed ratio:

1 : 1 (50% water, 50% coolant)

When the coolant capacity is 1 L.

Water	Coolant
500 cm ³ (16.9 USoz)	500 cm ³ (16.9 USoz)

Air filter service

The most critical aspect of routine maintenance on a racing machine is proper air filter maintenance. The air filter on a motocross machine must be serviced after every practice session and moto to ensure maximum engine performance and life. For convenience, many racers prepare two or three spare air filters ahead of time and simply switch filters between practices and motos.

Follow these instructions to service foam air filters correctly:

1. Remove the air filter from the machine, and wipe any excessive deposits of dirt from inside the air box. Check the box and the filter-to-carburetor joint for leaks or cracks.
2. Remove the cage from within the filter element.
3. Using uncontaminated cleaning solvent, thoroughly wash the filter element; wash it gently to avoid damage.



4. Squeeze the solvent from the filter element.

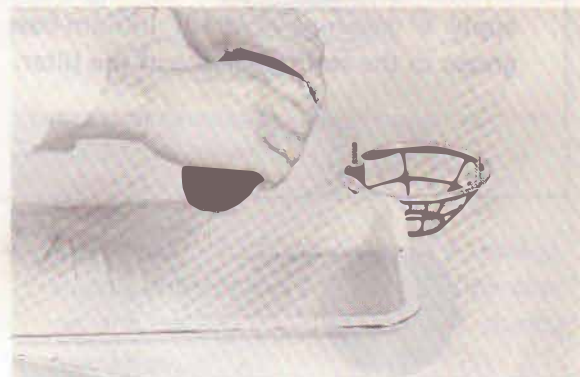

CAUTION:

Do not twist or wring the filter element, as it can easily be torn or otherwise damaged.

5. Using liquid dishwashing detergent and water, again wash the air filter element. Rinse the element with water, squeeze it, and allow the element to dry completely.

6. Pour a liberal amount of **high-quality, foam-air-filter oil** into a plastic bag. Put the filter element in the bag and thoroughly work the oil into the element.



CAUTION:

Never use motor oil on a foam air filter element. Motor oil will not remain suspended in the filter element.

7. Remove the filter element from the plastic bag and squeeze out the excess oil. Again, avoid twisting or wringing the air filter element. The element should be damp, but not dripping, with oil.
8. Reinstall the element on the cage, and apply a generous layer of lithium-base grease to the sealing surface of the filter.

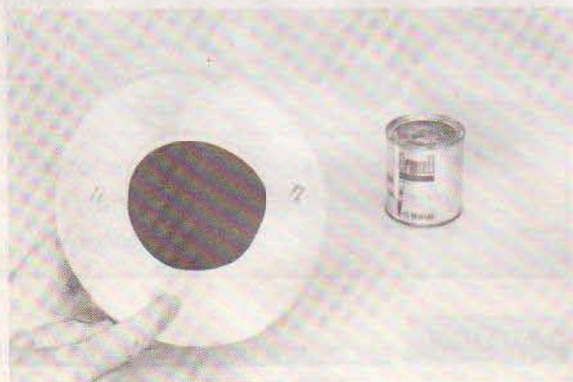

9. Reinstall the filter in the machine, and make sure the sealing surface of the filter is seated properly. Complete reassembly of the machine, and check all the fittings for tightness.

Break-in

During the break-in period, it is particularly necessary to check for loose parts and irregular operation of mechanisms. The following parts tend to come loose or stretch at the early stage of use and therefore, they should be checked periodically.

Securing handlebar

1. To keep the handlebar properly secured in place, it is necessary to correctly install the handlebar holders.
 - The punch mark located on top of the holder must always face forward.

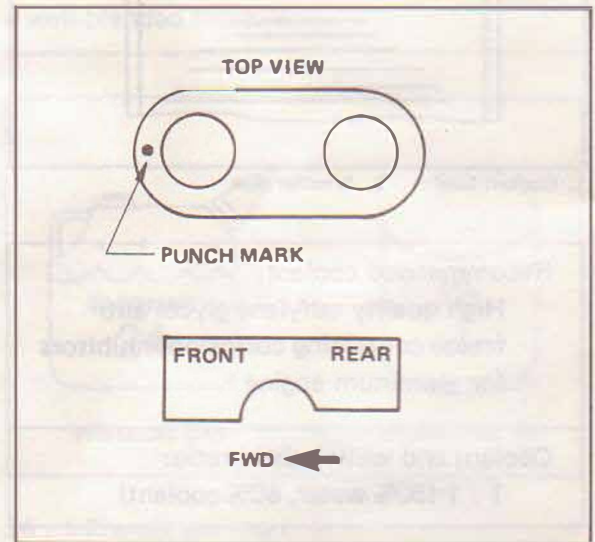

- Note the holder is longer on one end. The longer end always faces the front.
2. With the holder punch mark facing the correct direction, fully tighten the front flange bolts, then tighten the rear flange bolts to specified torque.

Tightening torque:

Refer to your owner's service manual for the specification.

Rear sprocket bolt tightening

Check the torque on the bolts holding the rear sprocket to the hub. These bolts require tightening on a regular basis; they must be checked during standard periodic maintenance.

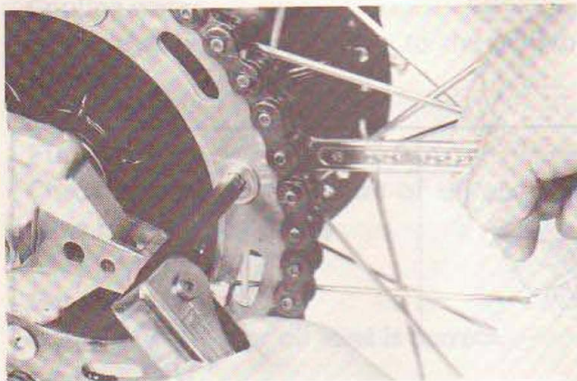

Spokes

Check the tightness of spokes prior to every race by tapping on each spoke. Whether or not the spoke is tight can be determined by the tapping sound.

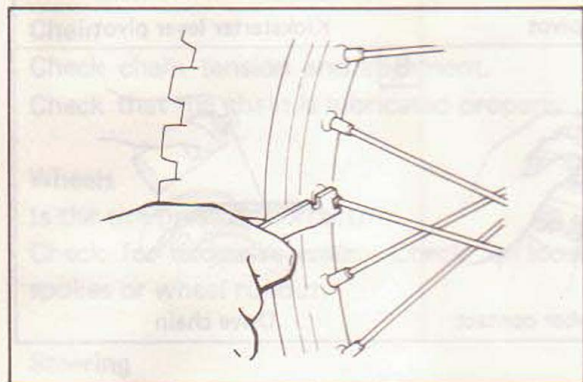

- Bent → Replace spokes.
- Loose → Tighten spokes.

CAUTION:

Avoid overtightening the spokes, as the hub may be distorted and braking power diminished.

- Check the rim locks for looseness regularly.

Drive chain

To check the alignment of the chain, make sure that the chain is lined up with the sprockets when viewed from the rear (A). If out of alignment (B or C), the chain should be aligned by turning the adjuster.

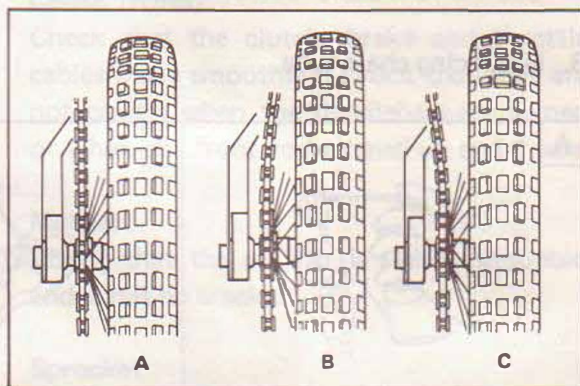

- When checking the chain, also check the chain link clip for damage, bends, or breaks, and if necessary, replace it.

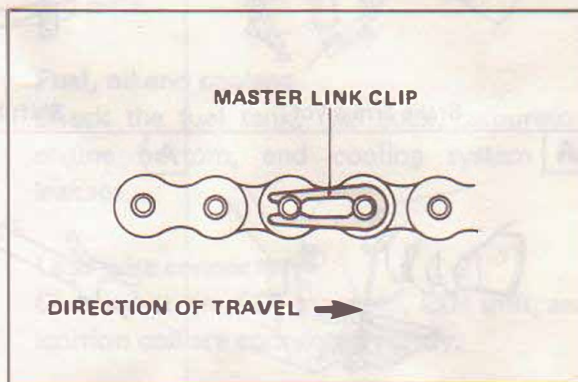

- Never use a half-link chain as a replacement. Always use a new chain link clip, or the chain could come off during operation.

Lubrication

To ensure smooth operation of all components, lubricate your machine during setup, after break-in, and after every race.

Before lubricating, thoroughly clean the machine of sand, dirt and water.

A. Use Yamaha cable lube or WD-40 on these areas.

B. Use racing chain lube.

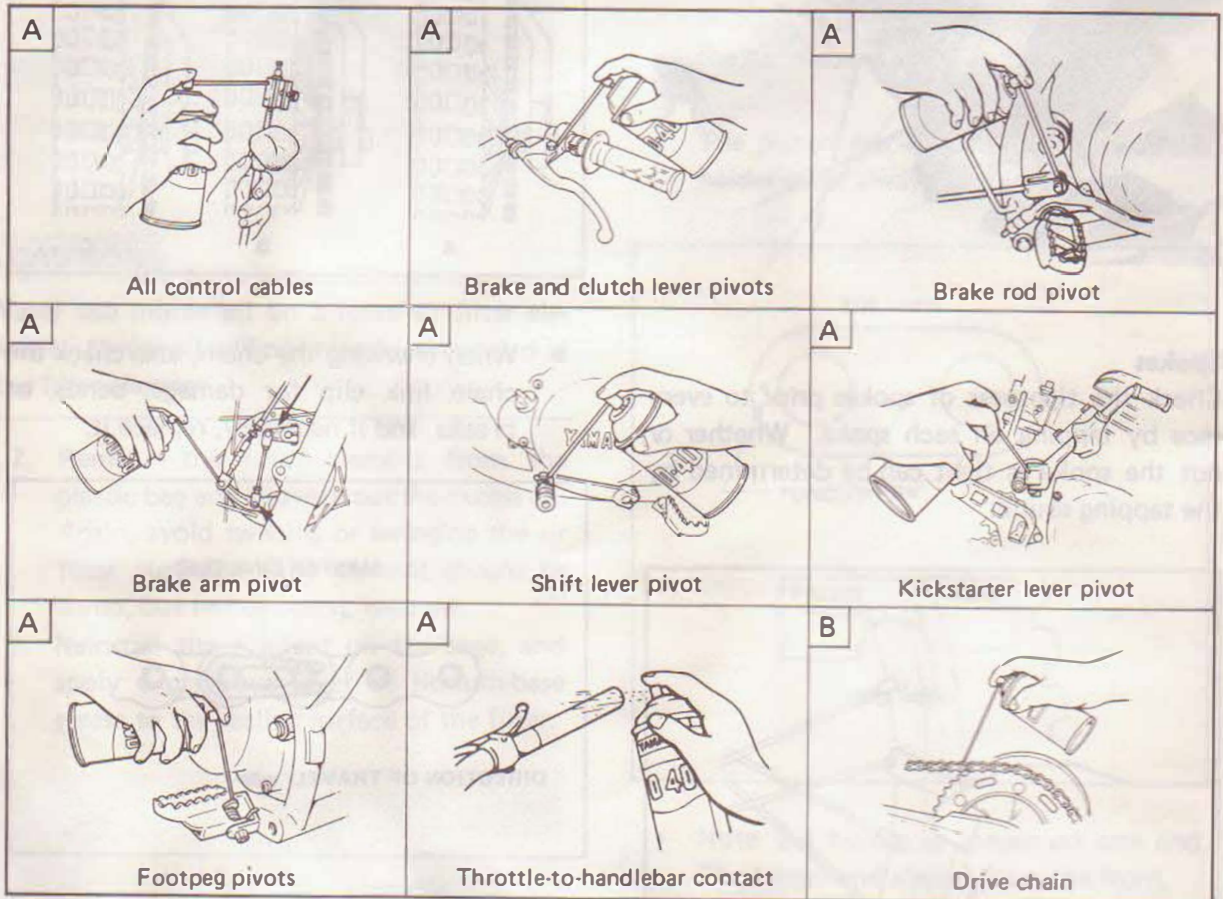

C. Use a high-quality, lithium-base grease.

1. Swingarm pivot
2. Lower rod pivot
3. Upper rod pivot
4. L-arm pivot
5. Lower shock mounting pivot
6. Both brake torque arm pivots
7. Brake backing plate bushing
8. Wheel axle

CAUTION:

Wipe off any excess grease, and avoid getting grease on the brake shoes.

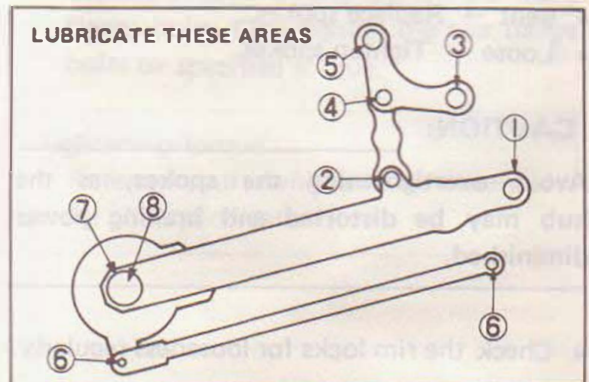

Preoperation checks

Before riding for break-in operation, practice or a race, make sure the machine is in good operating condition.

(For the procedure for inspection and maintenance, refer to the Owner's Service Manual).

INSPECTION AND MAINTENANCE

Cooling water

Check that water is filled up to the radiator filler cap.

Fuel

Check that a fresh mixture of oil and gasoline is in the fuel tank.

Gear oil

Check that the gear oil level is correct.

Gear shifter and clutch

Check that gears can be shifted correctly in order and that the clutch operates smoothly.

Brakes

Check the play of both front and rear brakes and their braking effect.

Chain

Check chain tension and alignment.
Check that the chain is lubricated properly.

Wheels

Is the tire pressure correct?
Check for excessive wear. Check for loose spokes or wheel runout.

Steering

Check that the handlebars can be turned smoothly and have no excessive play.

Front forks and rear shock

Check that they operate smoothly and there is no oil leakage.

The machine should be checked and serviced regularly so that a simple, minor adjustment of settings is required prior to a race.

Cables (Wires)

Check that the clutch, brake and throttle cables move smoothly. Check that they are not caught when the handlebars are turned or when the front forks travel up and down.

Muffler

Check that the muffler is tightly mounted and it has no cracks.

Sprocket

Check that the rear wheel sprocket tightening bolts are not loose.

Bolts and nuts

Check the chassis and engine for loose bolts and nuts.

Fuel, oil and coolant

Check the fuel tank, fuel cock, carburetor, engine bottom, and cooling system for leakage.

Lead wire connectors

Check that the CDI magneto, CDI unit, and ignition coil are connected tightly.

Settings

Is the machine set suitably for the condition of the racing course and weather, or by taking into account the results of test-runs before racing? Is inspection and maintenance completely done?

CARBURETOR TUNING

Tuning a carburetor is not the mysterious science many racers believe it to be. One needs only to establish a basic knowledge of the identification and function of carb components as well as how they work together to do the job well.

Some basics

The carburetor mixes air and fuel to burn in the engine. To allow the engine to produce optimum power under a variety of conditions, the carburetor must provide the correct ratio of air and fuel at all times. To accomplish this, the carb has several overlapping systems, and each system has its greatest effect in a specific rpm range. Thus, the tuner can consider each general engine-speed range one at a time; he can then adjust the appropriate systems to achieve smooth, strong power delivery throughout the entire rpm range of the engine.

If a carburetor is in need of tuning, the engine usually is said to be "running too rich" or "running too lean." These terms refer to the amount of fuel relative to the volume of air being taken into the engine. Hence, an engine that is too rich needs less fuel for a given volume of air; conversely, an engine running too lean needs more fuel for the air being taken in.

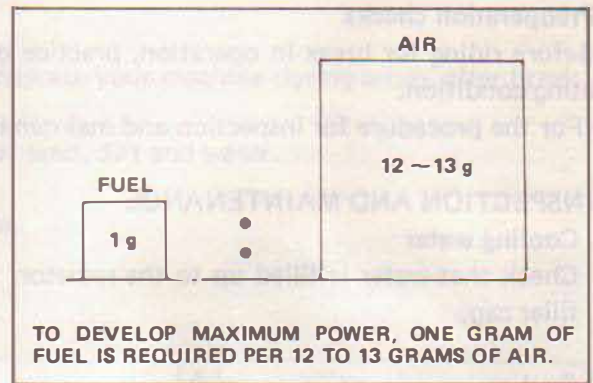
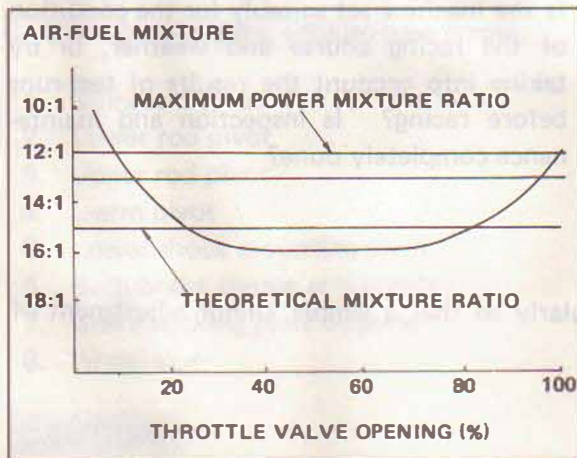

Tuning changes usually are required to accommodate changes in altitude. At higher altitudes, the air is "thinner" or less dense. This means there are fewer molecules of oxygen in a given volume of air to mix and burn with the fuel. The carb therefore needs to be made "leaner" to provide less gas and maintain the proper ratio of fuel to air at high altitudes.

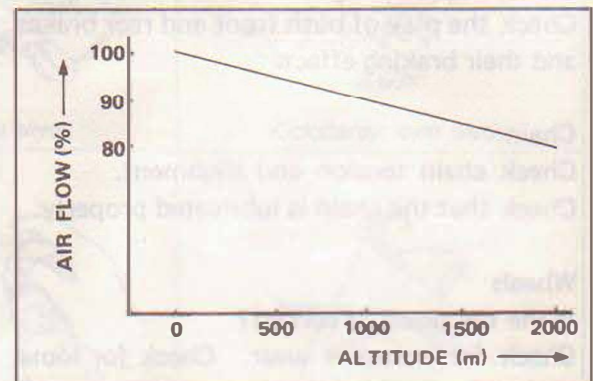

- Change due to elevation (at constant temperature).

If you race in an area with a wide range of temperatures, you might have to make carb adjustments for them. Higher air temperatures require leaner carb tuning. Such adjustments, however, should rarely be necessary for the majority of racers; motocross engines in general are sensitive only to the most extreme changes in such weather conditions.

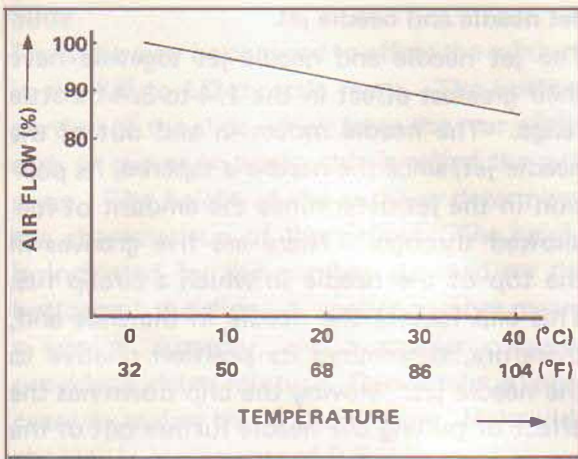

- Change due to temperature (at constant atmospheric pressure and humidity)

Condition	Mixture will be	Setting make
Cold air	lean	rich
Warm air	rich	lean
Dry air	lean	rich
Lowlands	Standard	
Highlands (Alt. above 1,500m)	rich	lean

The main jet should be increased or decreased one to five sizes by test until the engine gives maximum power.

Symptoms of improper settings

If your machine exhibits one or more of the symptoms listed below, it may need carb tuning changes. Before attempting any changes, however, make sure that everything else is in good shape and tuned properly. Check the condition of the spark plug, make sure the ignition timing is correct, service the air filter properly, decarbonize the muffler and spark arrestor, etc. If your machine has run properly at a certain track in the past and then starts running poorly with the same carb settings, the problem is almost certain to be elsewhere; changing the carb settings in such a case would be a waste of time.

If your bike is too rich, it will:

- Accelerate poorly;
- Misfire;
- Smoke excessively;
- Foul spark plugs;
- Have a "deep" exhaust note.

If your bike is too lean, it will:

- Ping or rattle;
- Accelerate erratically;
- Act like it's running out of fuel;
- Run extremely hot.

- If your bike pings or rattles, make sure the gasoline you are using is fresh and of a sufficient octane rating. You might also try different brands of high-octane gas.

Making setting changes

Carb setting changes are made by changing or adjusting six carburetor components. The six components and their relative positions in the carb are shown in the illustration below.

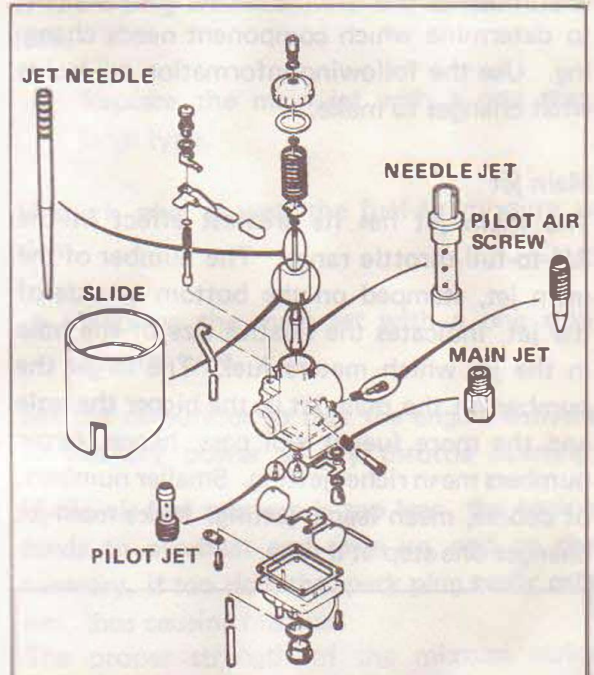

Four of the components, the jet needle, needle jet, main jet, and pilot jet, regulate the flow of fuel; the slide and pilot air screw regulate the flow of air. The following chart indicates the working range of each component. Note how the working ranges overlap each other as the throttle valve moves from closed to fully open.

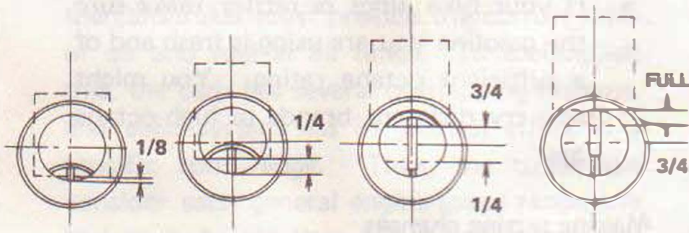
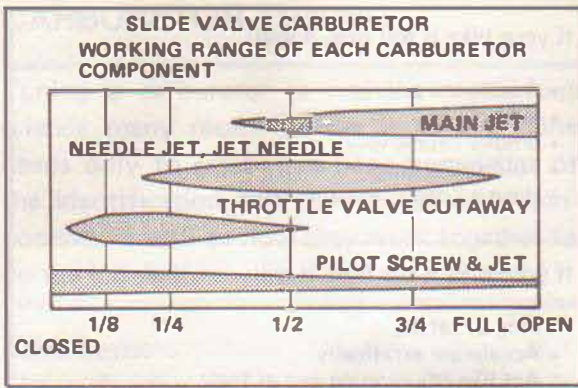

If you note a particular symptom of rich or lean running in a specific range, use the chart to determine which component needs changing. Use the following information to decide what changes to make.

Main jet

The main jet has its greatest effect in the 3/4-to-full-throttle range. The number of the main jet, stamped on the bottom or side of the jet, indicates the relative size of the hole in the jet which meters fuel. The larger the number on the main jet is, the bigger the hole and the more fuel it will pass; hence, larger numbers mean richer jetting. Smaller numbers, of course, mean leaner jetting. Make main-jet changes one step at a time.

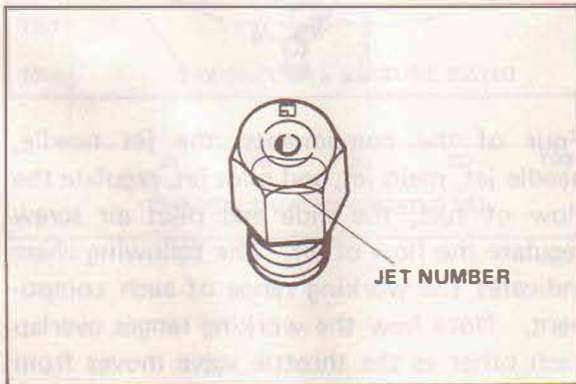

Jet needle and needle jet

The jet needle and needle jet together have their greatest effect in the 1/4-to-3/4-throttle range. The needle moves in and out of the needle jet; since the needle is tapered, its position in the jet determines the amount of fuel allowed through. There are five grooves in the top of the needle in which a circlip fits. This clip locates the needle in the slide and, therefore, determines its position relative to the needle jet. Moving the clip down has the effect of pulling the needle further out of the jet; the mixture is thereby richened. Moving the clip up leans the mixture. Change the clip position one step at a time.

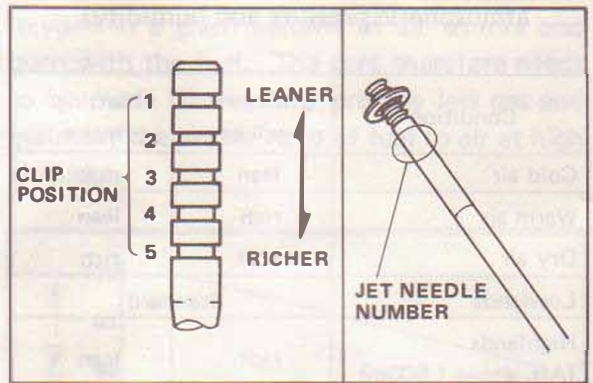

If changing the clip position doesn't provide the proper setting, the needle jet may be changed. This will make a large difference in the amount of fuel provided. On the side of the needle jet are stamped two figures, a letter followed by an even number; these figures indicate the relative size of the needle jet. The letter ranges from "N" (leaner) to "Q" (richer). The number will stand for one of five sizes within each letter's range. The smaller the number is, the leaner the needle jet. Change the needle jet one step at a time, and make fine adjustments with the jet needle clip.

When changing the Jet Needle for the standard Needle Jet, the jet needle length must be proper so that it will not slip off the needle jet at full throttle operation. (If the jet needle slips off, the machine may become uncontrollable.)

Slide

The slide may be changed to affect the mixture in the 1/8-to-1/2-throttle range. The bottom portion of the slide which faces the rear of the carb is cut at an angle; this is called the cut-away. The height of the cutaway determines the characteristic of the airflow. The height is indicated by the number stamped on the bottom of the slide. A smaller number means a smaller cutaway, and a smaller cutaway provides a richer mixture. Conversely, a larger cutaway makes the mixture leaner. Make slide changes in increments of 0.5.

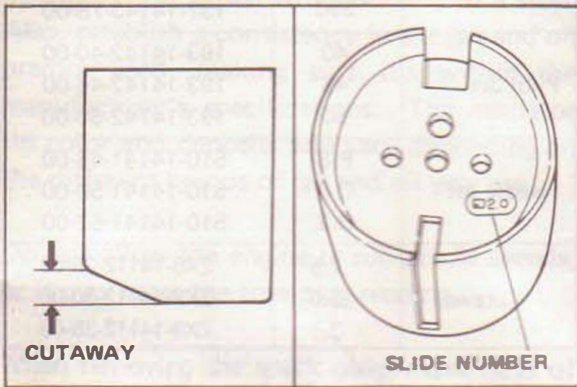

Pilot jet and pilot air screw

The pilot jet and pilot screw control the mixture in the closed-to-1/8-throttle range. To adjust the mixture in this range, the pilot air screw can be turned to change the airflow through the circuit, or the pilot jet can be changed to provide more or less fuel. Start by turning the pilot air screw. Screwing it in richens the mixture, and turning it out leans the mixture. Pilot air screw specs indicate the turns out from a lightly seated position. Make changes in 1/2-turn increments. If turning the screw between one and two-and-a-half turns doesn't provide the desired results, change the pilot jet. This jet has a number stamped on it which indicates its size; the larger the number is, the richer the jet. Make one-step changes in the pilot jet, and fine-tune with the pilot screw.

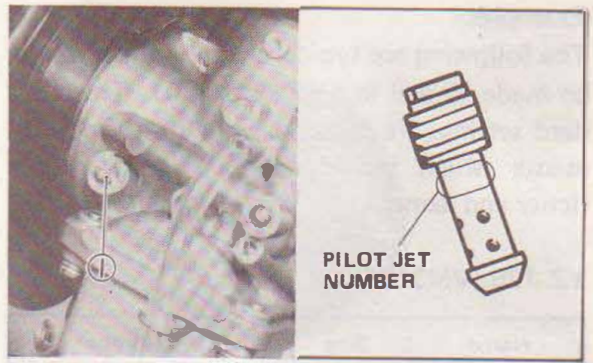

1. Pilot air screw

TEST RUNS

Warm up the engine with the carburetor at the standard settings, and run two or three laps of the course while examining the operating condition of the spark plug.

Test-ride the bike by varying the throttle opening.

Condition of spark plug	
Correct	Insulator is dry and light tan color.
Too hot	Insulator is whitish.
Too cold	Insulator is wet and sooty.

If spark plug is whitish, the fuel-air mixture is lean.

- Replace the main jet with a one step large type.

If spark plug is wet, the fuel-air mixture is rich.

- Replace the main jet with a one step smaller type.

Set the carburetor so that the engine delivers satisfactory power at any throttle opening.

If the air-fuel mixture is too lean, the engine tends to overheat and seize up, and on the contrary, if too rich, the spark plug easily gets wet, thus causing misfires.

The proper strength of the mixture varies depending on atmospheric conditions (pressure, humidity, and temperature).

Taking these conditions into consideration, adjust the carburetor settings properly.

- Take a note of carburetor settings as well as weather conditions, course conditions, and lap times so they can be utilized as reference data for future races.

Examples

The following are typical changes which would be made to dial in a YZ125J/250J. The standard settings are shown along with the adjustments which would make the carburetion richer and leaner.

YZ 125 (VM34SS)

Name	Size	Part Number
Main Jet	250	137-14143-50-00
	260	137-14143-52-00
	270	137-14143-54-00
	280	137-14143-56-00
	290	137-14143-58-00
Pilot Jet	60	193-14142-60-00
	65	193-14142-65-00
	70	193-14142-70-00
Needle Jet	P-8	239-14141-48-00
	Q-0	239-14141-50-00
	Q-2	239-14141-52-00
Cutaway	2.0	3R6-14112-20-00
	2.5	3R6-14112-25-00
	3.0	3R6-14112-30-00

YZ 250 (VM38SS)

Name	Size	Part Number
Main Jet	350	137-14143-70-00
	360	137-14143-72-00
	370	137-14143-74-00
	380	137-14143-76-00
	390	137-14143-78-00
Pilot Jet	40	193-14142-40-00
	45	193-14142-45-00
	50	193-14142-50-00
Needle Jet	P-8	510-14141-48-00
	Q-0	510-14141-50-00
	Q-2	510-14141-52-00
Cutaway	2.5	2X8-14112-25-00
	3.0	2X8-14112-30-00
	3.5	2X8-14112-35-00

SPARK PLUG

Spark plug reading

Proper spark plug reading is essential to achieve optimum performance and engine reliability. In order to achieve a proper plug reading, it will be necessary to perform the following: Install a new standard spark plug, warm up the engine, and run two or three laps of a course at maximum power output (on main jet circuit), then run at wide open throttle for approximately 15 seconds, stop the engine before closing the throttle and simultaneously disengage the clutch while braking to a stop. Also, establish a consistency in the gas and oil premix used, making sure it's within the manufacturer's specifications. The insulator tip color and deposits will vary depending on the different brands of gas and oil you use.

Do not allow the engine to run at idle speeds, or it may erase the true plug reading.

When removing the spark plug, make note of its torque (loose, correct or over tightened). The color and type of deposits on the spark plug insulator tip will give you a good indication of how this particular engine is operating.

Don't forget that a darker-than-normal color is quite common during the break-in period. Even at part-throttle operation, the spark plug may get only indicating that fuel is rich.

The following are some of the more common spark plug symptoms and how they relate to engine operating condition.

Normal:

Dark-brown-to-light-tan color with slight deposits and slight electrode wear. This indicates the engine has been running the way it has been designed to operate.

NOTE:

The optimum color for liquid-cooled YZs is slightly lighter than air-cooled YZs.



Rich: Dry, sooty black, carbon deposits. Possible cause: Rich air-fuel mixture, dirty air filter, excessive low-speed operation, weak ignition or incorrect heat range.



Oil fouled: Wet, black and oily deposits. Possible cause: Excessive low-speed operation, using an oil that is not recommended and/or an incorrect premix ratio, transmission oil entering the crankcase, rich air-fuel mixture, dirty air filter, low compression, weak ignition, incorrect heat range and/or spark gap or excessive exhaust carbon buildup.

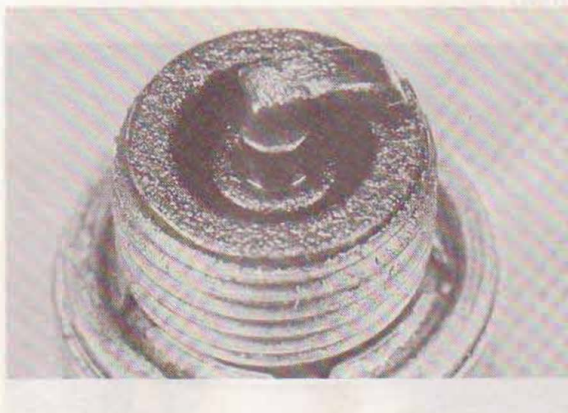

Overheating:

Light gray or white color. Insulator nose blistered, glazed, cracked or shows signs of aluminum speckles, and the electrodes are burned. May be accompanied by an audible "pinging/rattling." Possible cause: Lean air-fuel mixture or air leak, incorrect timing, insufficient cooling, incorrect spark plug heat range or improper spark plug installation (the tightening torque is too loose or the threads are dirty).

Tiny aluminum speckles on the insulator nose indicate an extremely high operating temperature due to preignition/detonation and melting of the piston crown. If this condition exists, it is vital the piston be inspected and the cause corrected before any future operation.

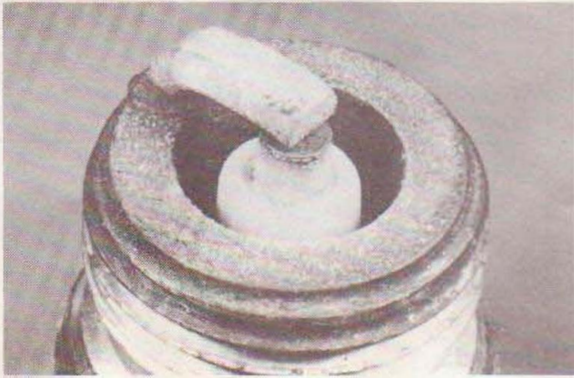

Gap bridging:

Carbon deposits lodged between the side and center electrode. Possible cause: An excessive amount of carbon buildup, using an oil that is not recommended and/or an incorrect pre-mix ratio, high-speed operation after excessive low-speed operation or dirt bypassing the air filter.



NOTE:

If a darker-or-lighter-than-normal plug color still exists after tuning, it may be necessary to make an adjustment to the main jet. If the plug shows symptoms of being rich (darker-than-normal), change to the next smaller main jet. If the plug shows symptoms of being lean (lighter-than-normal), change to a larger main jet. Make a test run after each change.

Additional information on spark plugs is available from spark plug manufacturers.

Spark gap

Spark gap is the distance between the side and center electrode.

NOTE:

When installing a new plug, the gap must be checked and adjusted to recommended specifications. Use a wire feeler gauge to check the gap, which is adjusted by gently bending the side electrode.

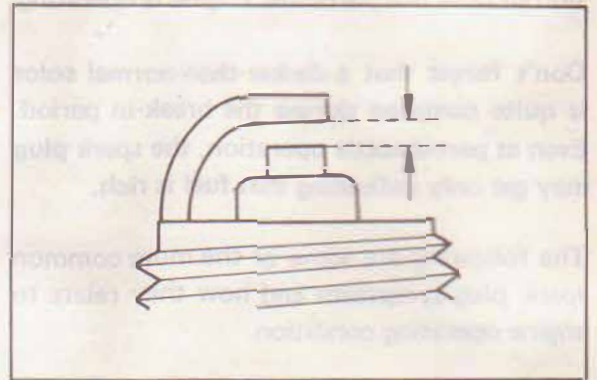

Tightening torque

The spark plug transfers combustion chamber heat directly from the firing tip of the insulator through the threads and gasket surface to the head. Therefore, the threads must be clean before the plug is installed. Also, most motorcycle heads are made of aluminum; to avoid stripping the threads, torque the plug to the manufacturer's specifications.

Normal condition:



Dark-brown-to-light-tan color with slight deposits and slight electrode wear.

Rich:



Dry, sooty black, carbon deposits.

Possible cause:

Rich air-fuel mixture, dirty air filter, excessive low speed operation, weak ignition or incorrect heat range.

Oil fouled:



Wet, black and oily deposits.

Possible cause:

Excessive low speed operation, using an oil that is not recommended and/or an incorrect premix ratio, low compression, weak ignition, incorrect heat range and/or spark gap or excessive exhaust carbon buildup.

Overheating:



Light gray or white color. Insulator nose blistered, glazed, cracked or shows signs of aluminum speckles, and the electrodes are burned. May be accompanied by an audible pinging/rattling.

Possible casue:

Lean air-fuel mixture or air leak, incorrect timing, insufficient cooling, incorrect spark plug, heat range or improper spark plug insulation.

Deposits:



Carbon deposits lodged between the side and center electrode.

Possible cause:

An excessive amount of carbon buildup, using an oil that is not recommended and/or an incorrect premix ratio, high speed operation or dirt bypassing the air filter.

Heat range

Heat range refers to the classification of the spark plug's ability to transfer heat from the firing tip of the insulator to the cylinder head. The motorcycle manufacturer has already determined through extensive testing the correct heat range for your machine. However, if an engine has been modified, it may require a change of heat range (one step) colder or hotter.

CAUTION:

Select a spark plug with a colder or hotter heat range carefully and cautiously. A spark plug with too hot of a heat range may lead to preignition and possible engine damage. A spark plug with too cold a heat range may foul as the result of too much carbon buildup.

Spark plug heat range comparison

Thread size	Plug type	Heat rating	CHAMPION	NGK	NIPPON DENSO
	Standard	Hot ↑ ↓ Cold	N-5 N-4, (N-4C) N-3, (N-3C) N-2, (N-2C)	B6ES B7ES B8ES B9ES	W20ES, W20ES-U W22ES, W22ES-U W24ES, W24ES-U W27ES
Dia.: 14mm (0.55in)	Gold palladium	Hotter type ↑ ↓ Colder type	N-5G	B6EV	W20ES-GU
Reach: 19mm (0.75in)			N-4G	B7EV	W22ES-GU
			N-3G, N-87G	B8EV	W24ES-GU
			N-2G, N-86G (N-86)	B9EV	W27ES-GU
			N-59G, N-84G (N-84)	B10EV	W29ES-GU
	N-57G, N-82G		W31ES-GU		

NOTE:

When any spark plug of other make is used in place of the N2C or N86:

- Use the B8EV or W24ES-GU for water-cooled engines.
- Use the B9EV or W27ES-GU for air cooled engines.

GEARING

Selection of the secondary reduction ratio (Sprocket)

$$\text{Standard secondary gear ratio} = \frac{\text{Number of driven sprocket teeth (48)}}{\text{Number of drive sprocket teeth (14)}}$$

Preconditions

- For instance, when the 48T sprocket is used for the standard gear ratio:

Course condition	Reduction ratio
• Fast course	Small (46T)
• Many curves • Sandy or soft ground	Large (50T)

- If the straight portion of a course is longer, the secondary reduction ratio should be reduced so that the machine speed can be increased.
- When the course has many corners or uphill or is wet, the secondary reduction ratio should be increased so that gear shifting is possible with smooth acceleration.

Actually, the speed must be changed depending on the ground condition on the day of race and therefore, be sure to run through the racing circuit prior to a race and set the machine suitable for the entire course of the circuit.

- If the straight portion of a course on which the machine can be run at maximum speed is longer, the machine should be so set that the maximum machine speed can be developed toward the end of the straight course, but care should be taken not to over-rev the engine.

- As a matter of fact, it is difficult to set the machine so as to best suit the entire course of the circuit. That is, some portions will have to be set with importance placed on the area where the result of the race is most affected. Also in this case, run through the entire course first and select the reduction ratio while taking a note of lap times so that the overall result is the best.

NOTE: _____

The technique of riding varies from rider to rider, and machine setting and power will also differ from machine to machine. Therefore, it is not clever to copy your machine setting from other riders at the beginning. Be sure to select the machine setting so that it matches your level of riding technique.

SUSPENSION TUNING

INTRODUCTION

No area of machine maintenance is more critical than proper suspension tuning. An improperly tuned suspension will keep even the best rider from attaining the full benefit of his machine's ability. Hence, follow the instructions in this chapter to adjust the suspension to the rider's specifications and course conditions.

WHILE TUNING THE SUSPENSION, YOU MUST BEAR SOME IMPORTANT POINTS IN MIND:

- If the machine is new, break in the suspension with at least four hours of riding before making any setting evaluations or changes.

Break-in:

To afford better riding comfort, the rebound damping is set on a two steps softer side. After the break-in period, return the monocross unit to the standard position (one punch mark). If the standard position does not suit your preference or course condition, make a readjustment or other necessary adjustment.

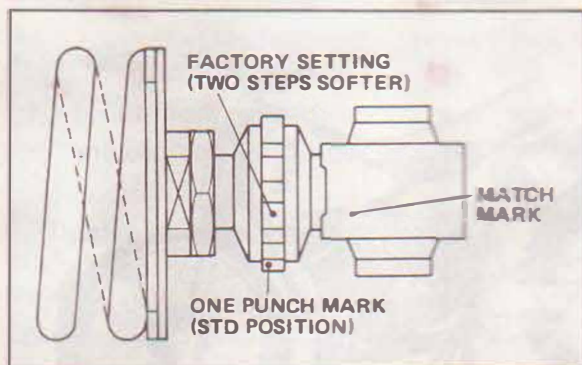

- The three major factors which must be considered in suspension tuning are RIDER WEIGHT, RIDER ABILITY, and TRACK CONDITIONS. Additional influences include the RIDER'S STYLE and POSITIONING on the machine.
- If you have any problem, make tests by changing your riding posture or position so that the cause of problem can be found out.

- It is a wise practice to adjust settings so as to best suit to straight lines, corners, or gaps, whatsoever you can most skillfully handle the machine in racing courses.
- Make setting changes in small increments; a little bit goes a long way, and it is very easy to overadjust a setting.
- The front and rear suspension should be balanced; when one is changed, the other might need to be changed similarly.
- When evaluating suspension performance the rider must make every effort to ride consistently and recognize the effects of his input; such things as changes in rider position and increasing fatigue may lead to incorrect judgments about necessary setting adjustments.
- When the proper settings have been determined for a particular track, they should be written down for reference upon returning to that track.
- Lubricate the bushings in the brake torque arm and backing plate as well as the shock mounting-eye pivots after brake-in and after every race to prevent excess friction from affecting suspension performance.

FRONT FORK

Fork oil level

The fork oil level in the fork tube is adjustable. The change in the fork oil level will not affect the damping force at the early stage of fork travel, but it will have a great effect at the later stage.

- When the oil level is raised:
The air spring in the later half stage of travel is stronger, and thus the front fork is harder.
- When the oil level is lowered:
The air spring in the later half stage of travel is lessened, and thus the front fork is softer.

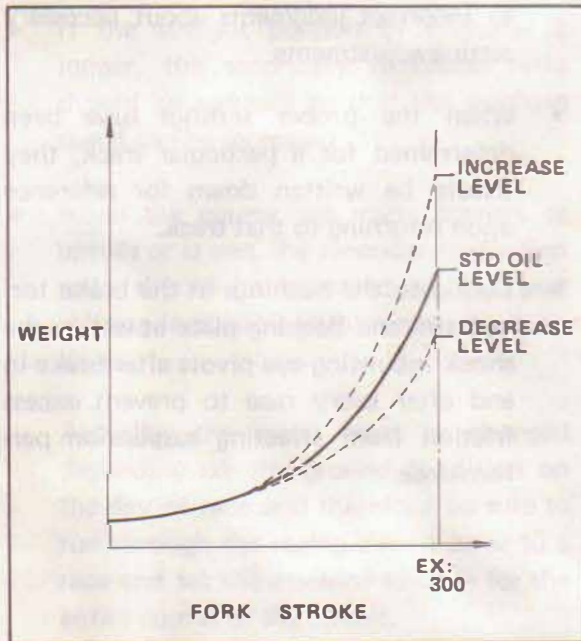

The oil level works on effectively at the end of fork travel.

NOTE:

Raising oil level 10 mm (0.4 in) is equivalent to adding approximately 3 psi of air pressure.

If fork bottoming is experienced raise fork oil level in 10 mm (0.4 in) increments. This will change the secondary spring rate.

Oil level adjustment

1. Place a suitable stand under the engine to keep the front of machine raised off the floor.
2. Remove the valve cap.

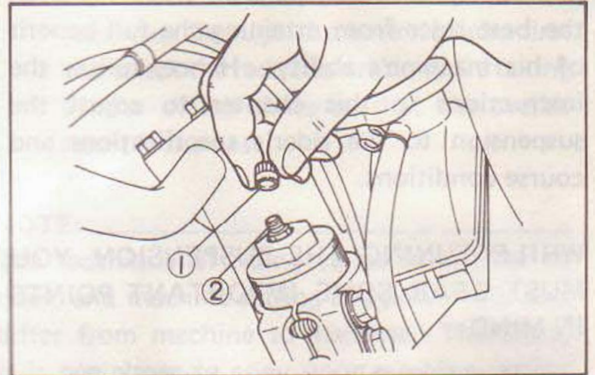

1. Valve cap 2. Valve

3. Using a slotted-head screwdriver, depress the valve to allow the air to escape from the fork legs.
 4. Remove the cap bolt assembly. And remove the spacer, spring seat and fork spring.
 5. Measure the oil level from top of the fork tube with oil level tool. The fork tubes must be fully bottomed.
- To raise the oil level, once add oil and adjust the level to the desired position.
 - To lower the oil level, it can be lowered straight.

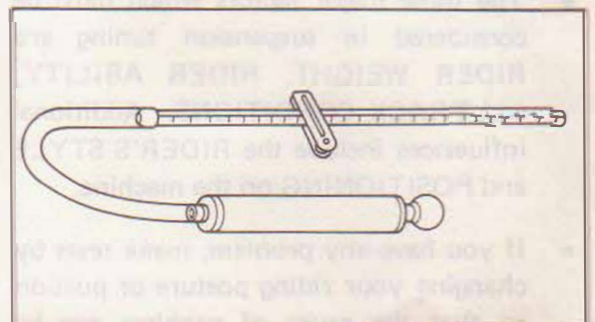

T/No. YM-59000

The oil level is adjustable in variations of 5 mm (0.2 in) or 10 mm (0.4 in).

The oil level adjustment is allowed in the range from the minimum to maximum shown in the Owner's Manual.

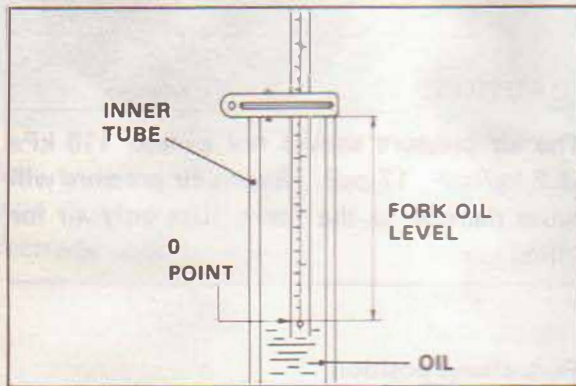

6. Inspect the O-ring on cap bolt and replace if damaged.

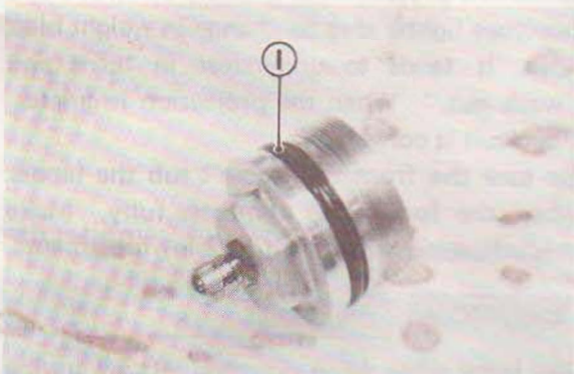

1. O-ring

7. Install fork spring, spring seat, spacer and cap bolt and torque to specification.

Tightening torque:

Refer to your owner's service manual for the specification.

NOTE:

The cap bolt should be turned once counter-clockwise, and make sure it is seated correctly, then tighten to specification.

- * After changing the oil level, check the front fork travel effectively.

Fork oil weight

The fork oil viscosity (weight) can be changed. The fork oil viscosity greatly affects the damping force produced by the front forks. For instance, to maintain a constant damping in summer and winter, the oil viscosity (weight) may be changed.

- Thicker oil (From #7.5 to #10): damping is increased, and the fork moves slowly.
- Thinner oil (From #7.5 to #5): damping is decreased, and the fork moves quickly.

Fork spring

In addition to the standard type, two different type fork springs are sold. A proper spring should be selected according to the conditions of a racing course or the weight of the rider.

NOTE:

Always check the oil levels before changing or re-installing springs.

- Using the heavy spring: Increases the preload; the fork becomes stiffer and rebounds more quickly.
- Using the light spring: Decreases the preload; the fork becomes softer and rebounds more slowly.

Air pressure

Although it is possible to change the air pressure in the forks, it is better to change the oil level first to gain the desired air-spring effect.

The change in the air pressure affects the air-spring effect throughout the entire range of fork travel.

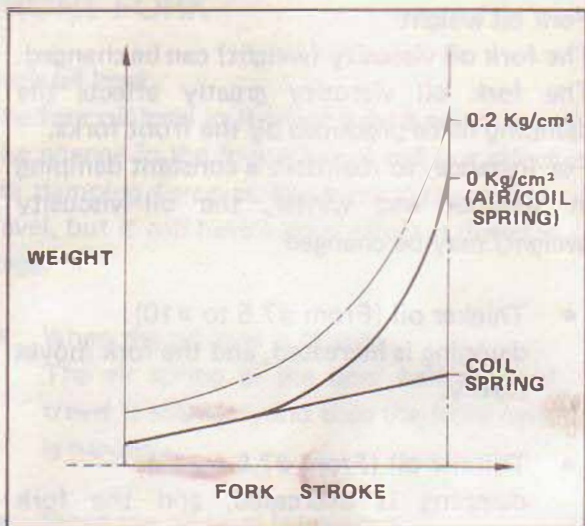

- Increase air pressure → causes initial load to increase, and the fork becomes hard.
- Decrease air pressure → causes initial load to decrease, and the fork becomes soft.

Remember, 0 psi air pressure in forks and release any pressure build-up after each moto.

1. Place a suitable stand under the engine to keep the front of machine raised off the floor. No weight on front wheel.
2. Using the air check gauge, adjust the air pressure to specification.

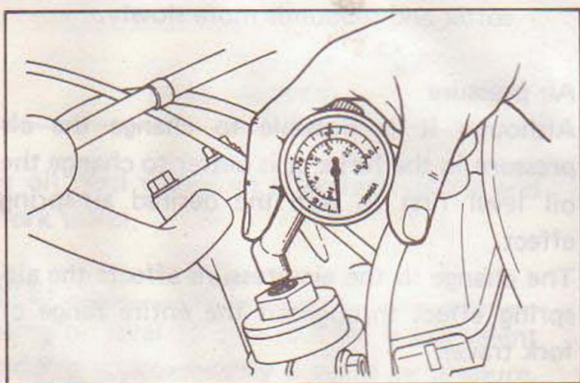

3. The difference between both right and left tubes should be 9.8 kPa (0.1 kg/cm², 1.4 psi) or less.

Standard air pressure:

Refer to your owner's service manual for the specification.

CAUTION:

The air pressure should not exceed 118 kPa (1.2 kg/cm², 17 psi). Excess air pressure will cause damage to the forks. Use only air for filling.

Fork clamp position

Steering qualities are greatly affected by the fork clamp position (the amount of the inner tube projection over the handle crown).

When the projection is smaller, the front end becomes lighter due to change in weight bias. Also, it tends to understeer in turns and "wash out." When the projection is greater, the result is converse.

Be sure the front tire doesn't rub the fender when the fork tubes compress fully. Make this adjustment in 5 mm (0.2 in) increments.

CAUTION:

The inner tubes, both right and left, should be projected evenly.

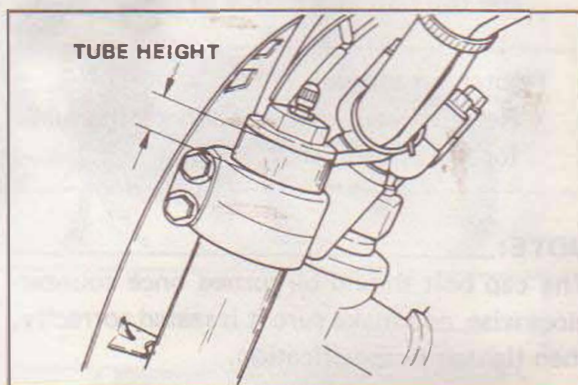

REAR SHOCK (MONOCROSS SUSPENSION "DE CARBON" SYSTEM)

Spring preload

The preload is adjusted by changing the set length of the spring: a shorter set length increases the preload, a longer set length decreases the preload.

- Shortening the set length: increases the preload; the shock becomes stiffer and rebounds more quickly.
 - Lengthening the set length: decreases the preload; the shock becomes softer and rebounds more slowly.
1. To adjust the preload, remove the shock absorber and loosen the lock nut.
 2. Adjust the spring set length by turning the spring adjuster with the special wrench.

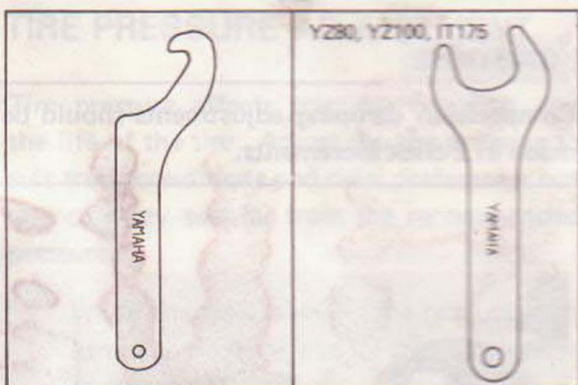

To increase the preload, turn the spring adjuster clockwise. To decrease the preload, turn the spring adjuster counterclockwise.

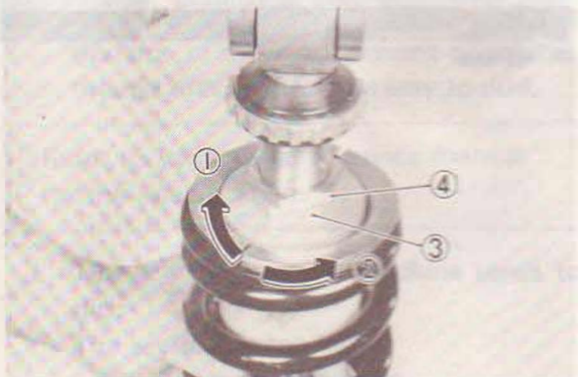

1. Increase preload
2. Decrease preload

3. Adjuster
4. Lock nut

One complete turn of the adjuster will change the preload 1 mm (0.04 in). Make changes in increments of 2 mm (0.08 in) at a time.

CAUTION:

Never attempt to turn the adjuster beyond the maximum or minimum setting.

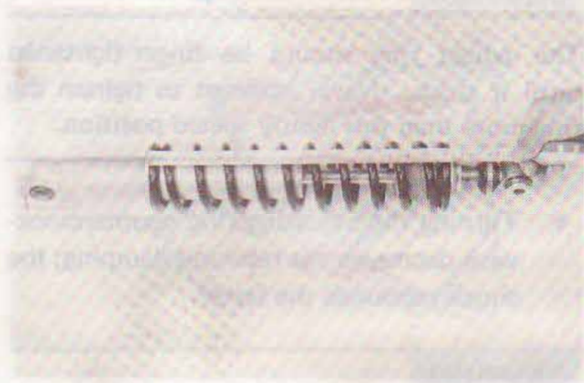

NOTE:

Always tighten the lock nut against the spring adjuster and torque the lock nut to specification.

Tightening torque:

Refer to your owner's service manual for the specification.

Spring replacement

In addition to the standard spring, heavy and light springs are available. If the standard spring is improper for your purpose, select a proper one according to the rider's weight or course conditions.

- Using the heavy spring:
The spring rate is higher; the spring is stiffer and rebounds more quickly.
- Using the light spring:
The spring rate is lower; the spring is softer and rebounds more slowly.

Rebound damping

The rebound damping is adjustable by turning the adjusting ring next to the shock's rear mounting bracket.

- Turning the adjusting ring clockwise increases the rebound damping; the shock rebounds the slower.

CAUTION:

The adjust ring should be finger-tightened until it stops. Never attempt to tighten the ring more than this lightly seated position.

- Turning the adjusting ring counterclockwise decreases the rebound damping; the shock rebounds the faster.

CAUTION:

Turn the adjuster until it clicks. Don't loosen the adjuster more than ** clicks from the lightly seated position.

**Refer to your owner's service manual for the specification.

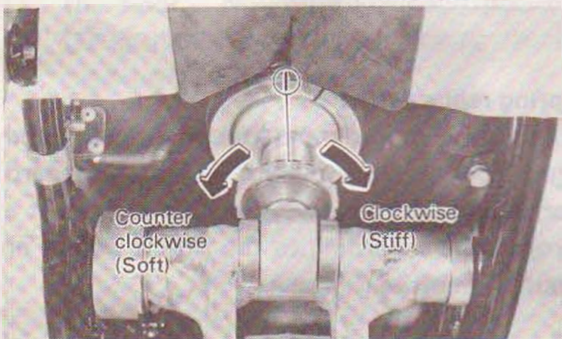

1. Adjuster

NOTE:

Looking at the adjusting ring from the rear of the bike.

CAUTION:

Adjust the damping in increments of 2 clicks. And test the performance by riding after adjustment.

When adjusting, always turn the adjusting ring all the way clockwise and then make the desired adjustment.

For reference purposes, always record the settings for a cold shock.

Compression damping

(If so equipped)

The compression damping can be adjusted by turning the adjuster at the front of the shock (under the seat).

- Turning the adjuster clockwise increases the compression damping. That is, the rear shock is hard to sink and therefore, the cushion is felt hard.
- Turning the adjuster counterclockwise decreases the compression damping. That is, the rear shock sinks easily and therefore, the cushion is felt soft.

CAUTION:

Compression damping adjustments should be made in 2-click increments.



1. Adjuster

CAUTION:

- Finger-tighten the adjuster until it clicks.
- Tighten the adjuster until it stops. Don't screw it in more than this position.
- Avoid loosening the adjuster more than 15 clicks from stiffest position.

Gas pressure

The gas pressure in the remote nitrogen chamber can be changed to make fine adjustments in the springing characteristics of the shock; higher pressure stiffens the shock slightly, and lower pressure makes it slightly softer. This adjustment is rarely needed, however, and it requires special equipment. Consult your Yamaha dealer if you wish to change the nitrogen pressure in the shock.

TIRE PRESSURE ADJUSTMENT

Tire pressure affects traction, handling, and the life of the tire. Adjust the tire pressure to suit track conditions and rider preference, but do not stray too far from the recommended pressure.

1. When the trail is wet in the rain, muddy, sandy or slippery, reduce the tire pressure to increase the tire tread.

Refer to your owner's service manual for the specification.

2. When the trail is pebbly or hard, increase the tire pressure to prevent punctures, though tires will become easy to skid.

Refer to your owner's service manual for the specification.

3. Tire grip is poor and machine tends to slip:

Tire pressure is too high.

.....Reduce tire pressure.

CAUTION:

When the tire pressure is low, loose rim locks may allow the tire to slip on the rim. Check for loose rim locks. Make sure the valve stem is square in the rim hole. If not square, adjust its position properly.

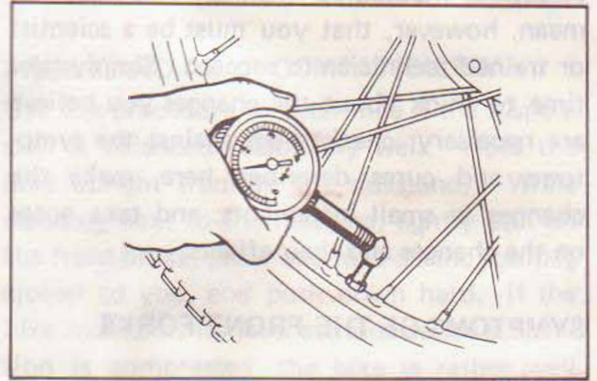

TROUBLESHOOTING IMPROPER SETTINGS

Listed below are some symptoms of improper suspension settings and the most likely means of correcting them.

The proper settings can be achieved by applying the information in this chapter in a scientific, methodical manner; this does not mean, however, that you must be a scientist or trained technician to succeed. Simply take time to think about the changes you believe are necessary, check them against the symptoms and cures described here, make the changes in small increments, and take notes on the changes and their effects.

SYMPTOMS OF THE FRONT FORKS

Too hard

1. The front forks are too stiff
 - the springs are too strong.
2. The front forks stiffens up at the end of stroke
 - the fork oil level is too high.
3. The front forks operate but a hard ride is felt
 - the spring preload is too high or air is built up in fork.

Remember:

Release any air pressure that may build up after each moto.

Too soft

The front forks dive much when the brake or throttle is not applied.

1. Fork oil level is low.
2. Springs are too soft.
3. Spring preload is low.

NOTE:

Keep the oil level constant on right and left.

SYMPTOMS OF THE REAR SHOCK

Too hard

1. The suspension is too stiff
 - compression damping is too high
 - spring is too hard.
2. The suspension operates but a hard ride is felt
 - unbalance between the spring and rebound damping.
3. Spring preload is too hard.

NOTE:

Apply high temperature grease to pivot points of the monoshock and brake backing plate bushing.

Too soft

On landing after a big gap, bottoming occurs (Normally OK)

- spring preload is too soft or compression damping is too soft.
- spring is too soft.

DETERMINING THE PROPER SETTINGS

Standard settings

From the factory, the machine is set up for an intermediate-weight rider and possessing intermediate riding ability. Hence, if the actual rider weighs considerably more or less than this level, or if his riding experience and ability are quite greater or lesser than the intermediate level, it is likely that some rough adjustment can be made to put the suspension "in the ballpark."

Intermediate rider weight

Class	Rider Weight
80	40-45 kg (90-100 lb)
100	60-65 kg (130-140 lb)
125-175	65-70 kg (140-155 lb)
250-490	70-75 kg (155-165 lb)

READJUSTMENT OF THE SUSPENSION

Ground surface

Smooth	Light spring
Rough	Heavy spring

Riding experience

Beginner	Light spring with more rebound damping (2-4 clicks)
Experienced	Heavy spring

Rider's weight

Heavy	Heavy spring
Light	Light spring

Type of course

Many corners	Lower the front end slightly. (Increase the fork tube height 5mm (0.2in)) Quick in steering turning ability
Fast course with many jumps	Raise the front end slightly. (Decrease the fork tube height 5mm (0.2 in)) Slower steering gives greater stability at high speed
Deep sandy whoops ground	Raise the front end slightly. To gain stability

After making such preliminary adjustments, begin the actual on-track testing and evaluation.

Remember

1. Always make changes in small increments.
2. Make sure the rider is consistent in his evaluation of improper suspension performance.
3. A change in the front suspension might require a change in the rear, and vice versa.

FRONT AND REAR COMPATIBILITY

Use this procedure to determine if the suspension is balanced reasonably well: Hold the bike upright (remove the sidestand). While standing next to the machine, lightly pull on the front brake, place one foot on the footpeg closest to you, and push down hard. If the bike maintains its level attitude as the suspension is compressed, the bike is rather well balanced. Sit astride the bike and take a riding posture. Next check to see that the bike is in a horizontal position. If one end drops noticeably more than the other, however, the front and rear are not compatible and must be readjusted to achieve better balance.



GENERAL SYMPTOMS AND REMEDY

This is one of the most effective adjustment procedures but suspension settings should vary depending on the condition of racing courses or the rider's preference.

Front end searching during down hill or acceleration at out of corner:

Front fork is soft. Step 1 Decrease the tube height 5 mm (0.2 in).
..... Step 2 Increase the oil level 10 mm (0.4 in).
..... Step 3 Use alternate stiffer fork spring.

Front end "knifes" or oversteers in turns:

(Front end tends to turn inward)

Front fork is too soft Step 1 Increase oil level 10 mm (0.4 in).
Step 2 Decrease tube height 5 mm (0.2 in).

NOTE: _____

Heavier or expert riders may need the heavy
spring.

Front end pushes or "washes out" in turns:

(When a front wheel tends to push outward rather than "bite" in a turn)

Front fork is too stiff Step 1 Check air pressure 0 kPa (0 kg/cm², 0 psi).
Step 2 Decrease oil level 5 – 10 mm (0.2 – 0.4 in).
Step 3 Increase tube height 5 mm (0.2 in).

NOTE: _____

The softer spring may be required for lighter
or less experienced riders.

Front fork doesn't respond to small bumps in sweeping turns:

Front fork is too hard Step 1 Decrease oil level 10 mm (0.4 in).
(Standard oil is used.)
Step 2 Decrease fork oil weight # 10 to = 7.5.
(Standard spring is used.)
Step 3 Use light duty spring.

Rear end "kicks" when braking over bumps:

The shock probably has too little rebound damping
..... Increase the rebound damping 1 or 2 clicks.

Rear tire won't "hook up" out of corners:

(A lack of traction coming out of turns)

The shock may be too stiff Step 1 Decrease the rear shock spring preload 2 mm
(0.08 in).
Step 2 Decrease the compression damping 1 or 2 clicks.
Step 3 Use light spring (In case of a lightweight rider).

Bike lands on the front wheel off high speed jumps:

(This may be due to improper riding posture)

Rebound damping is too fast (Or spring is too hard)

- Step 1 Increase rebound damping by 2 clicks each time.
- Step 2 Decrease the shock spring preload 2 – 3 mm (0.08 – 0.12 in).
- Step 3 Decrease the compression damping 1 or 2.

Front and rear of the bike bottom off high-speed jumps:

(If harsh bottoming occurs once or twice per lap of the race)

Front and rear suspension system are too soft

- Step 1 F/F : Increase oil level 10 mm (0.4 in).
R/S : Increase spring preload in 2 mm (0.08 in) increments.
Use heavy spring.
- Step 2 F/F : Use heavy spring.
R/S : Increase compression damping by 1 or 2 clicks or use heavy spring.

NOTE: _____
After make adjustment, check front and rear compatibility.

Adjustment depending on bottoming condition: (Rear shock)

- Bottom at low speed Increase spring preload in 2 mm (0.08 in) increments until maximum preload is achieved.
If bottoming still occurs use alternate heavy spring.
- Bottom after successive 3 or 4 jumps Decrease rebound damping 2 clicks.

NOTE: _____

The rear shock on this machine may mislead some riders.

- a. The rear shock bottoms when the spring and damping are overcome by the total weight of the machine and rider (due to full stroke).
- b. A bottoming sensation may actually be the inability of rider and machine weight to overcome an overly stiff spring or excessive damping.

Observe the rear end off jumps; if it doesn't approach bottoming, try lowering the spring preload and damping.

SETTING RECORD TABLE

The data shown here is an example of entry. For your actual use, copy the necessary data from the Owner's Manual.

Event name	Supercross		
Date	Jan/30		
Weather	Fine		
Place	Anaheim		

Setting specs.

Ignition timing	1.88mm (0.07 in)		
Spark plug	N-84		
Carburetor			
Main jet	# 260		
Jet needle	6F21-3		
Needle jet	Q-0		
Cutaway	2.5		
Pilot jet	# 65		
Air screw	1 and 1/2		
Gearing	62/18		
Front fork			
Spring	k = 0.285		
Collar length	5 mm (0.2 in)		
Oil quantity	454 cc		
level	150 mm (5.9 in)		
weight	10 wt		
Air pressure	0 psi		
Fork tube height	10 mm (0.4 in)		
Rear shock			
Spring	k = 3.0		
Preload	342 mm (13.5 in)		
Damping rebound	10		
compression	5		
Gas pressure	114 psi		
Front tire (pressure)	14 psi		
Rear tire (pressure)	14 psi		

NOTE:

1. Make setting changes in small increments.
2. When the proper settings have been determined for a particular track, they should be written down for reference upon returning to that track.
3. Always make adjustment in cold state.



YAMAHA MOTOR CO.,LTD.

IWATA JAPAN

www.legends-yamaha-enduro.com

PRINTED IN JAPAN
83·6-5.0x1