



*Vintage Yamaha
Enduro Fans*



YAMAHA

SINGLE ENDURO

RIDERS MANUAL
175 CT1B

The lower half of the cover features an abstract geometric design. It consists of several overlapping triangular and quadrilateral shapes. A prominent red triangle points upwards from the bottom right corner. To its left, a grey triangle points downwards from the top left. A red diagonal line runs from the middle left towards the center. The background is a light greyish-white color.

Congratulations! You are now the owner of a new Yamaha SINGLE ENDURO 175CT1B. The CT1B is a high-performance motorcycle manufactured by the leading manufacturer of motorcycles in Japan.

The CT1, the newest and top of the Yamaha line model is designed for competition and high-speed road use. It features a rugged, powerful, 2-stroke single cylinder engine, and Autolube, the revolutionary lubricating system developed by Yamaha Technical Research Laboratory and prove in all Yamaha models.

This manual explains some steps necessary for operating and caring for your new motorcycle. Please read it carefully to become thoroughly familiar with all the features and advantages built into your CT1B.



CONTENTS

I. Features and Specifications	3
1. Features	3
2. Specifications	5
3. Performance Curves	8
II. Yamaha Autolube	9
III. Nomenclature	10
IV. Basic Instructions	13
1. Gasoline and Oil	13
2. Familiarization of Equipment	13
3. Pre-operation Check	18
4. Operation	19
5. Break-in Procedure	22
V. Service Tools	23
VI. Inspection and Service	24
1. Periodic Inspection Guide	24
2. Inspection and Adjustment	25

I. Features and Specifications

1. Features

(1) High-performance Single Cylinder Engine

The Yamaha Enduro 175 CT1B utilizes a powerful, two-stroke 175 c.c. engine. The new five-port cylinder, which is another Yamaha. Technical development, greatly improves engine efficiency, and is responsible for high power output throughout a broad RPM range.

(2) Highly-dependable Yamaha Autolube

Yamaha Autolube provides superior engine lubrication that extends the service life of the engine.

(3) Easy Starting

The engine can be started by simply disengaging the clutch and kicking the kick pedal without shifting gears back to neutral. This is a valuable convenience to the rider.

(4) Powerful Brakes

Patented waterproof, dustproof brake drums provide safe, fade-free braking on wet or dusty roads.

(5) Adjustable Rear Cushion

The rear cushions are adjustable to three positions. The rider can adjust spring tension to compensate for varying weights, speeds, and road conditions.

(6) Front Fork Design

The Yamaha Enduro 175 CT1B employs a front fork design well-known for its strength and superior handling characteristics. Its use assures the rider of the ultimate suspension for even the roughest terrain.

(7) Speedometer and Tachometer

A speedometer and tachometer are standard equipment. The individual units are separately mounted for maximum visibility. An additional feature of the speedometer is an odometer which can be reset by tenths to zero for trip or enduro purposes.

(8) Tires

The Yamaha CT1B is fitted with Dunlop Trials Universal tires as standard equipment. This particular tread is one of the most versatile available. It gives maximum trail traction, yet is compatible with road usage.

(9) Carburetor Starter Feature

Yamaha's starter feature is already well-known for providing easy starting. Equipped with this unique carburetor, the Yamaha CT1B is quick starting under all conditions.

2. Specifications

Performance & Specifications Model CT1B

Dimensions:	
Overall length	77.4 in.
Overall width	35.8 in.
Overall height	43.1 in.
Wheelbase	50.6 in.
Min. ground clearance	9.1 in.
Weight:	
Net	211 lbs
Performance:	
Max. speed	65 mph plus
Fuel consumption (on paved level roads)	129.4 mpg @25 mph
Climbing ability	32°
Min. turning radius	74.8 in.
Braking distance	58.3 ft./31 mph.
Engine:	
Model	CT1
Type	2 stroke gasoline,
Lubricating system	Separate lubrication (Yamaha Autolube)
Cylinder	single, forward inclined, 5-port
Displacement	10.43 cu., in. (171 cc)
Bore × Stroke	2.598 × 1.969 in. (66 × 50 mm)
Compression ratio	6.8 : 1
Max. power	15.6 BHP/7,000 rpm
Max. torque	11.9 ft-lb/5,500 rpm
Starting	Primary-coupled kick starter system
Ignition method	Magneto ignition system

Carburetor:	
Type	VM24SH
M. J.	#150
J. N.	4D3-3 stages
Air cleaner:	Wet, foam rubber
Spark plug:	B-8E
Chassis:	
Frame	Tubular-Double loop
Suspension Front	Telescopic
Rear	Swinging arm
Transmission:	
Clutch	Wet, multiple-disk
Primary reduction system	Gear
Primary reduction ratio	3.894 (74/19)
Gear shifting type	Constant mesh, 5 speed
Gear ratio 1st	3.182 (35/11)
2nd	2.000 (30/15)
3rd	1.368 (26/19)
4th	1.000 (23/23)
5th	0.800 (20/25)
Secondary reduction system	Chain
Secondary reduction ratio	2.813 (45/16)
Steering:	
Steering angle	49°
Caster	60.5°
Trail	4.8 in.

Tire size:	
Front	3.25-18-4PR (Trial Universal)
Rear	3.50-18-4PR (Trial Universal)
Lighting:	
Head light	6V 25W/25W
Tail light	6V 7W
Stop light	6V 23W
Meter light	6V 3W×2
Battery:	
Model No.	MV1-6D
Capacity	6V 2AH
Magneto model:	F130
Tanks:	
Gasoline tank capacity	1.9 u.s gal.
Oil tank capacity	1.3 u.s qt.

3. Performance curves

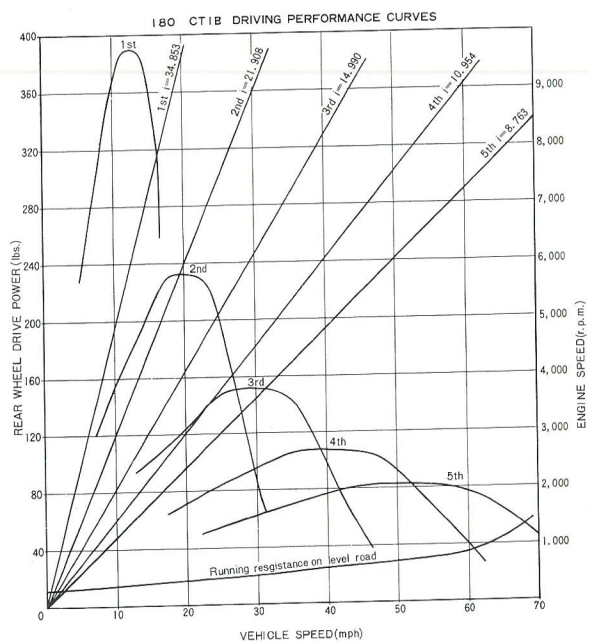
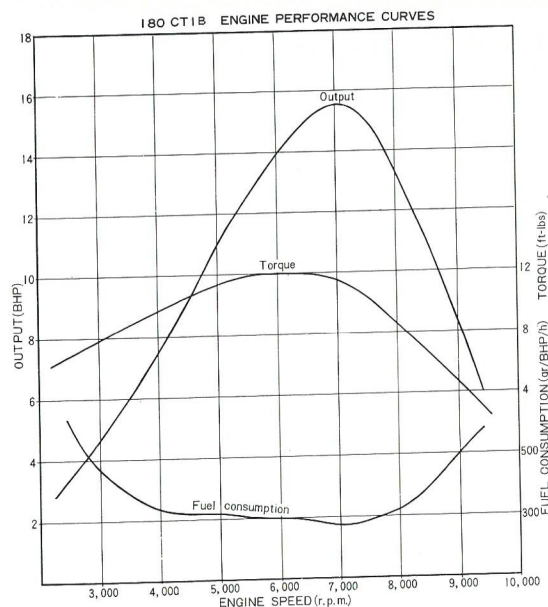

II. Yamaha Autolube

What is Yamaha Autolube?

Yamaha Autolube is an automatic lubrication system which obsoletes the conventional two-stroke premixing system. Oil stored in the oil tank is metered automatically to the engine, by an oil pump, with the quantity varying according to engine speed and load.

The heart of the system is the compact, precisionbuilt oil pump. Driven off the engine crankshaft through reduction gears, the varying oil needs are regulated by the pump which feeds the oil directly to the engine. Regulation is controlled through engine rpm's and throttle setting.

Features:

Yamaha Autolube eliminates the lubrication problems peculiar to two-stroke engines with the conventional "pre-mixing" system. Oil is never contaminated by gasoline prior to delivery to the engine, nor is it subject to de-naturing through storage in the gas tank.

1. The Autolube system results in:

- Oil consumption up to $\frac{1}{3}$ LESS than that of previous lubrication systems.

- Greatly reduced carbon build-up.

- Reduced exhaust emission

2. The Autolube system provides:

- Fresh oil supply

- Complete lubrication due to large oil particles

- No worries about the compatibility of oil and oil-fuel mixing ratios

3. The Autolube system means:

- Fuel-"straight" gasoline only

- No pre-mixing of oil and gasoline

III. Nomenclature

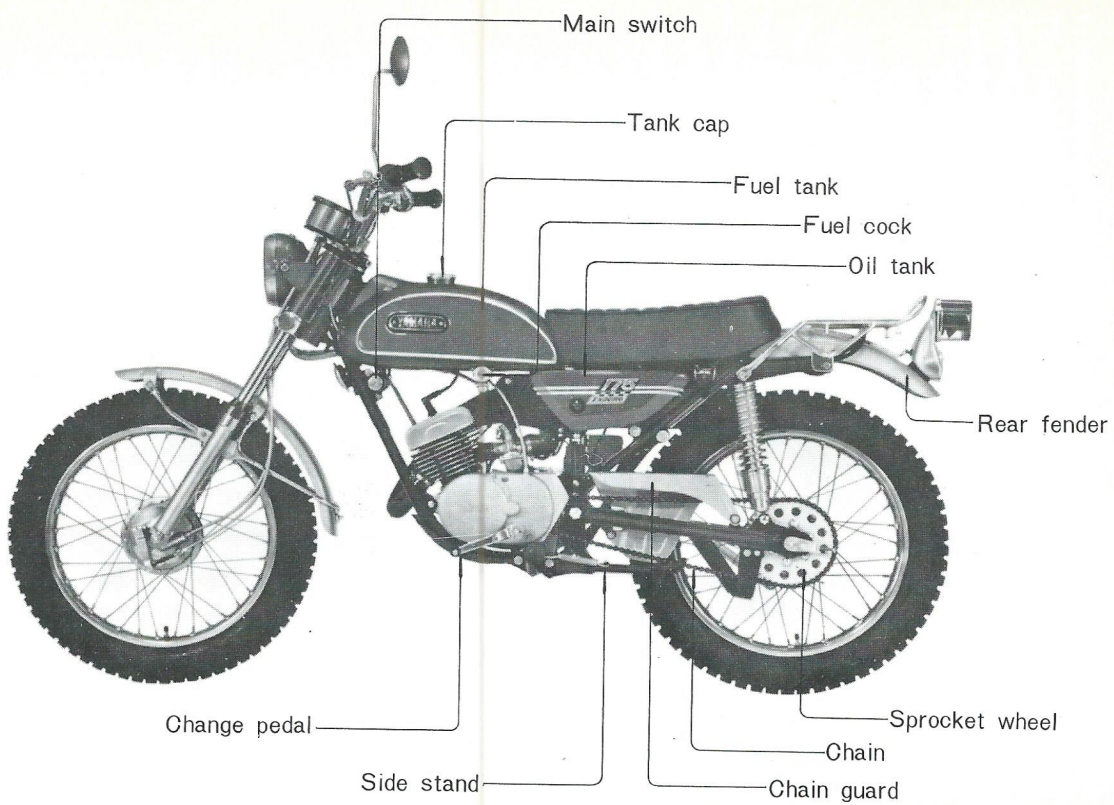
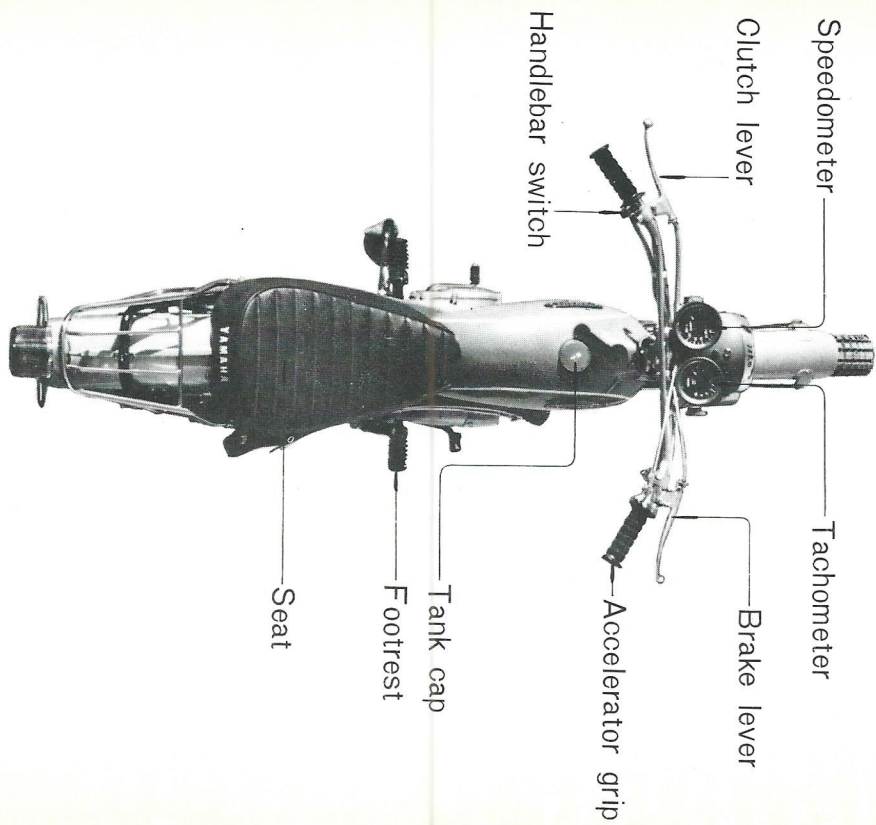

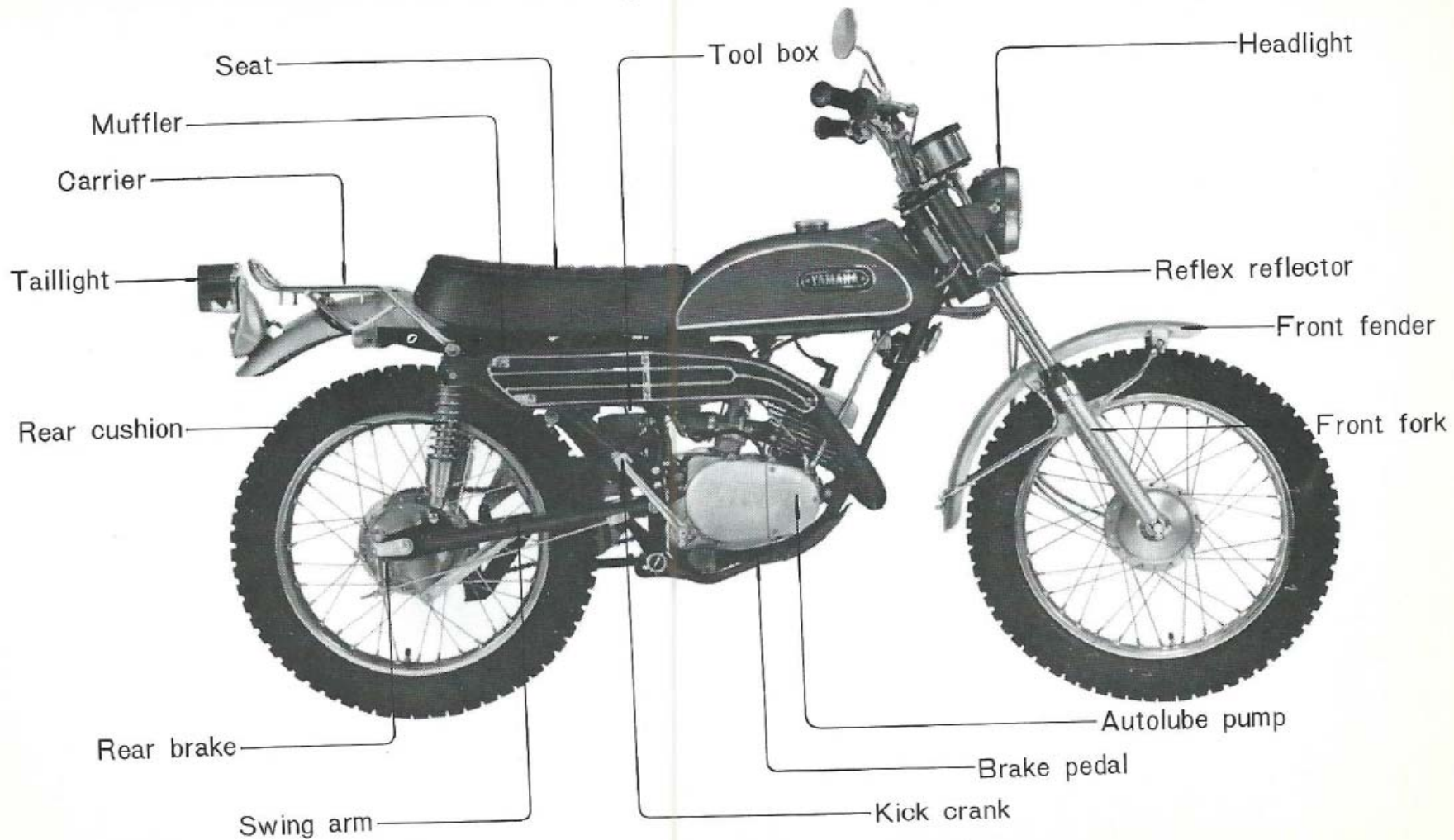

IV. Basic Instructions

1. Gasoline and Oil

The Yamaha Enduro 175 CT1B, equipped with the Yamaha Autolube system, uses straight gasoline as fuel.

Gasoline: Use gasoline of 90 octane rating or more.

Oil: Use Oil for lubrication.

Store it in the separate oil tank located under the seat.

[Autolube Oil]

The Yamaha Autolube Oil(YAMALUBE), refined especially for this new lubricating device, excels in lubrication, cleanliness and liquidity at low temperatures. The performance of the Autolube depends on the quality of oil. Yamaha Autolube Oil is recommended for higher performance and longer life of the engine.

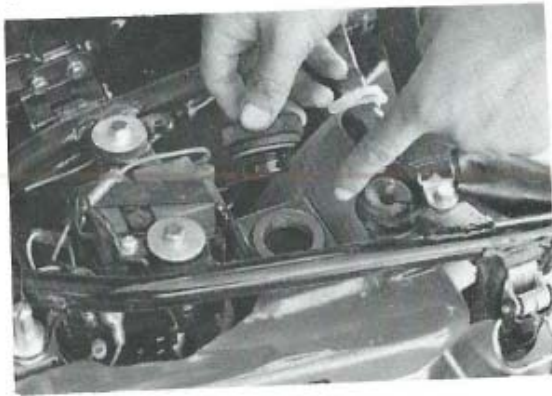

2. Familiarization of Equipment

(1) Main Switch

The main switch has three key positions, OFF, Ignition, and Ignition + Lights.

The following chart shows the key positions at which the various system are switched on or off. (The circle (o) denotes "Switch on".)

	OFF	I	II	Instructions
Engine		○	○	To start the engine, kick the kick pedal.
Neutral light		○	○	The change pedal is in neutral.
Meter lamp			○	The engine is running.
Headlight			○	The engine is running.
Taillight			○	
Stoplight		○	○	The brake is applied.
Horn		○	○	The horn button is depressed.

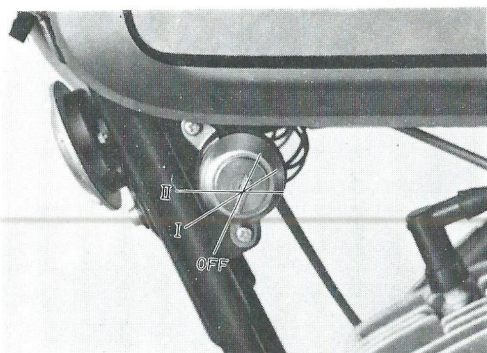

(2) Fuel Petcock

To allow the fuel to flow into the carburetor, turn the fuel petcock lever to ON. Should you run low of fuel while driving, turn it to RESERVE. The reserve position will enable you to drive approximately 25 miles (40 km). When parking, the lever should be turned to STOP.

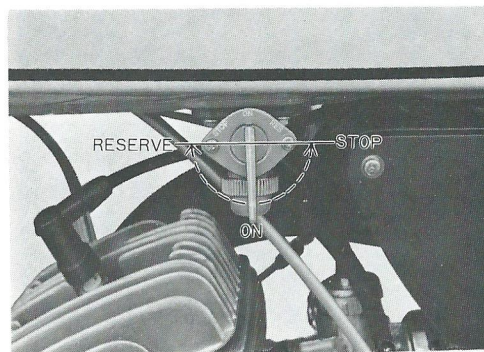

(3) Handlebar Switches

- a. To sound the horn, depress the horn button.
- b. To raise the head light beam, pull the switch toward you. To lower the beam, push the switch toward the front.

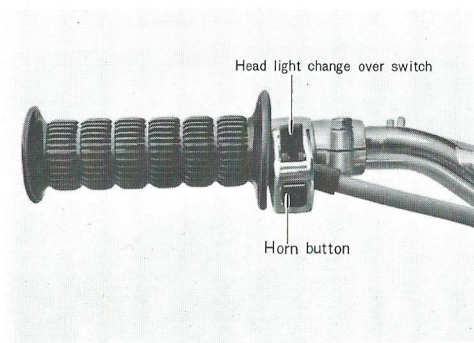

(4) Trip Total Meter

A trip total meter is built in the speedometer. It is designed to show the total mileage of each trip. Before starting a trip, set the trip total meter to the zero position.

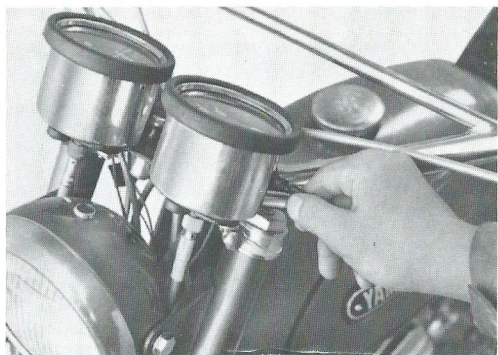

(5) Rear Cushions

The rear cushions can be adjusted according to load, road conditions, and rider preference.

- To adjust the rear cushion insert the screwdriver (service tool) buttend of the blade into the adjusting hole and then turn it in order to change the position of the toothed notch.

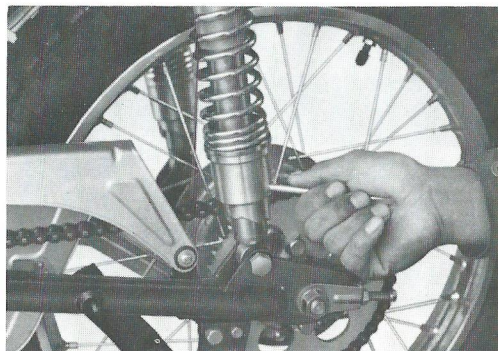

(6) How to Read the Tachometer

A tachometer is provided so that the rider can easily maintain engine RPM sufficient to keep the engine within the power curve. The standard Yamaha CT1B is designed to run best in the power range between 3,000 rpm and 7,000 rpm. Never lug your engine! It is recommended not to use red-zone 8,000 ~10,000 r.p.m.

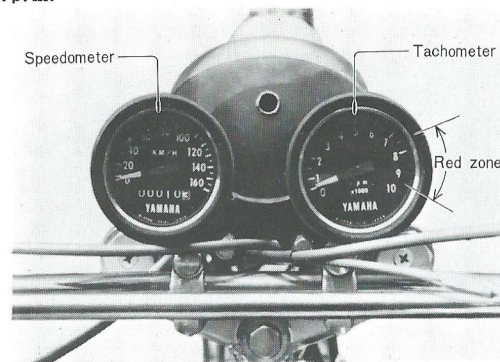

The relationship between engine RPM's and gears is shown in the diagram on the this page.

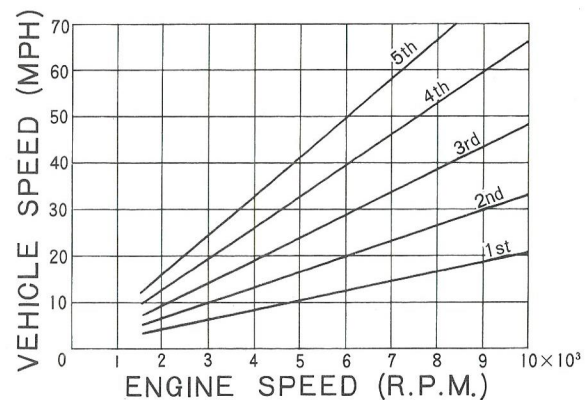

3. Pre-operation Check

You should check the following points before each usage.

(1) Is there sufficient fuel?

Make sure that there is sufficient fuel for your driving plan. Fill the fuel tank with gasoline only.

(2) Is there sufficient oil?

If the oil is below the center hole on the glass view port, refill the oil tank with Yamaha Autolube Oil or SAE #30 detergent motor oil.



(3) Is the tire pressure correct?

The wrong tire pressure affects the riding comfort, steering, and life of tires.

Correct tire pressure:

Front - 14 lbs/in² (1.0 kg/cm²)
Rear - 17 lbs/in² (1.2 kg/cm²) } For on-the-road-riding

When the tire pressure is reduced below the specified value because of some reason, the tire may slip around the rim. To prevent this slipping of the tire, bead stoppers should be used.

(4) Do the front and rear brakes work effectively?

Try the brake lever (right handlebar) and the foot brake (on the right side of the engine). Check to see if the stoplight is functioning.

(5) Do the lights and horn function well?

Check the horn, stoplight, headlight, meter lamp, etc.

4. Operation

(1) Starting the Engine

The Yamaha Enduro 175 CT1B employs the kick starter system. The carburetor is provided with a starting system to produce the rich air-fuel mixture required for easy starting of the engine. It assures quick starting even in extremely cold weather.

Preparation for Starting

- Turn the fuel cock lever to the "ON" position.
- Insert the main switch key and turn it to the "Ignition" position. Make sure the neutral light is on.

The 175 CT1B is equipped with a primary kick starter.

The engine can be started by kicking the kick pedal when the transmission is in neutral or by disengaging the clutch first if the transmission is in gear.

Starting When the Engine is Cold

Most engines are more difficult to start in cold weather. For easiest starting, a richer mixture of gas/air can be obtained by operating the starter lever.

- Depress the starter lever.
- Start the engine by kicking the kick pedal with the accelerator grip closed.

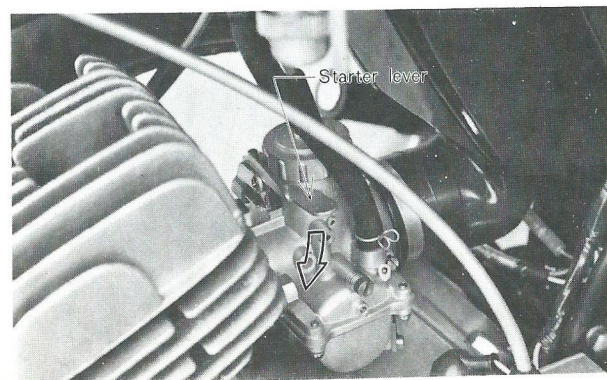

Starting When the Engine is Warm

When the engine is still warm from running or in warm weather:

- Don't use the starter lever.
- Slightly open the accelerator grip, and kick the kick pedal.

Warming Up

It is very important to allow a warming-up period of 2 minutes or so after starting the engine.

After the engine has started, the depressed starter lever must be released. Keep the accelerator grip open until the engine begins to run smoothly.

Correct engine warm-up, along with periodic inspections, will assure a longer performance life from your engine.

(2) Operation Procedure

Shifting Gears:

The Yamaha 175 CT1B is equipped with a foot-operated, 5-speed transmission.

To shift into NEUTRAL, move the toe section of the change pedal downward into 1st and then raise it slightly to the neutral detent.

The neutral position is between the First and the Second gear position.

FIFTH
FOURTH
THIRD
SECOND
NEUTRAL
FIRST

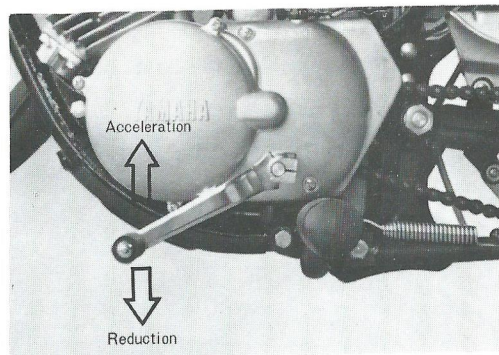

Acceleration

- Pull in the clutch lever to disengage the clutch.
- Depress the toe section of the change pedal down into FIRST.
- Slowly twist the accelerator grip (the engine speed begins to increase), and release the clutch lever gently. Done properly, the machine will accelerate smoothly.

Road Shifting.

After starting off, accelerate to approximately 10 mph (15 km/h)

- Disengage the clutch while closing the accelerator grip.
- Shift into SECOND by raising the toe section of the change pedal one full position.
(In this case, the neutral position is bypassed)
- Increase engine speed slowly and release the clutch lever. Accelerate to approximately 20~25 mph (30~40 km/h) and shift into THIRD.
- Decelerate by reversing the above procedure. Close the accelerator grip, disengage the clutch, and then depress the change pedal.

Off-the-road Riding

When you ride your motorcycle over rough land, safety parts may break or fall off due to shocks from the ground or due to accidents such as falling, and breakage or loss of parts may result. It is advisable to remove all safety parts before you start riding.

Parts to be removed: Headlight, taillight, speedometer, tachometer, and side stand.

Caution on Riding over Paved Roads at High Speeds:

The CT1B is equipped with tires having a block pattern. As a result, the area where the tire contacts the ground is smaller compared with other types of tires. Therefore, take care not to slip your motorcycle when you are cornering at high speeds and at sharp angles.

(3) Stopping

To stop the machine, gradually reduce speed by closing the throttle and apply the front and rear brakes simultaneously.

Remember to apply the front and rear brakes together when running at high speeds. Applying only one brake may cause skidding or overturning.

5. Break-in Procedure

To secure a longer life for your Yamaha 175 CT1B, a certain period of breaking-in operation is very important.

During the first 600 miles (1,000 km), the various parts of the engine wear and polish themselves to the correct operating clearances. It is important to avoid prolonged full throttle operation which might result in excessive heating during this critical period.

Care taken at this time will result in longer life, better dependability and higher performance.

V. Service Tools

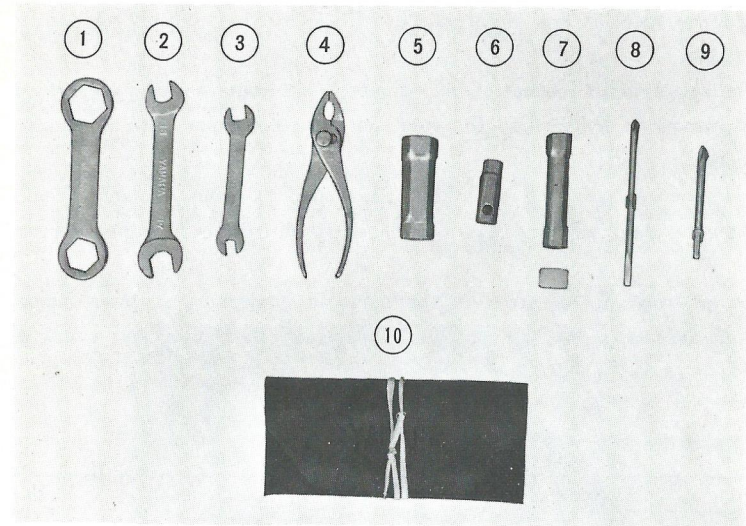

1. 22 $\frac{m}{m}$ \times 26 $\frac{m}{m}$ double-ended spanner
2. 13 $\frac{m}{m}$ \times 17 $\frac{m}{m}$ spanner
3. 8 $\frac{m}{m}$ \times 10 $\frac{m}{m}$ spanner
4. Pliers
5. 17 $\frac{m}{m}$ \times 21 $\frac{m}{m}$ socket wrench
6. 10 $\frac{m}{m}$ socket wrench
7. Screwdriver handle and 13 $\frac{m}{m}$ socket wrench.
8. \oplus \ominus screwdriver
9. \oplus screwdriver
10. Tool bag

VI. Inspection and Service

Regular inspection and maintenance will keep your motorcycle in top condition.

Daily or periodic inspection by yourself or your Yamaha dealer not only assures a longer life for your motorcycle but prevents any machine trouble.

Remember to have the periodic inspection by your Yamaha dealer; otherwise, your machine will not be entitled to the Yamaha warranty plan.

It is advisable, in addition to the periodic inspection at your Yamaha dealer according to the Periodic Inspection Card, that you check the machine parts listed below every 30~60 days.

1. Periodic Inspection Guide

	Check point	Instructions	P. Ref.
1	Front and rear brake	Adjustment	25, 26
2	Clutch	Adjustment	27
3	Gear oil	Level and replacement	28
4	Battery electrolyte	Refilling	29
5	Spark plug	Cleaning	30
6	Air cleaner	Checking and cleaning	31
7	Carburetor	Adjustment	32
8	Drive chain	Adjustment and oiling	33
9	Muffler	Cleaning	35
10	Cylinder head and piston	Cleaning	35
11	Screws, bolts and nuts	Retightening	36

Be sure to check the above points before long-distance touring.

2. Inspection and Adjustments

The methods of inspection and adjustment are discussed below. This information will be of value in your daily inspections.

Adjusting the Brakes

Front Brake:

The correct free play of the front brake lever is 0.2 to 0.3 in. (5 to 8 mm). To adjust, turn the cable adjusting bolt at the front wheel and/or the adjuster located at the lever. After adjustment, be sure to tighten the lock nut fully.

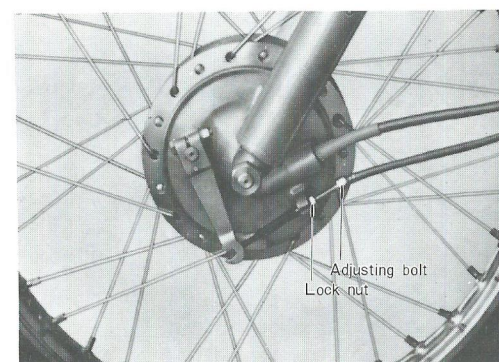
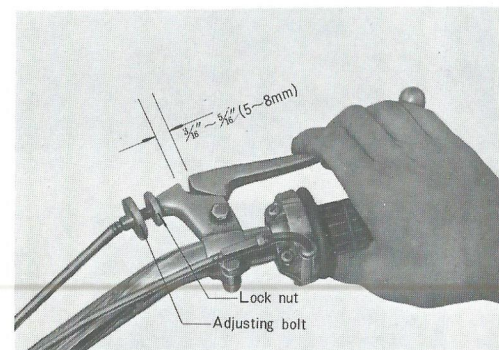

Rear Brake:

The correct free play of the rear brake pedal is approximately 1 in. (25 mm). To adjust the play, turn the adjusting nut that is attached to the rear brake cable end, one-half turn at a time.

After the adjustment, check the stop light to see if it functions properly.

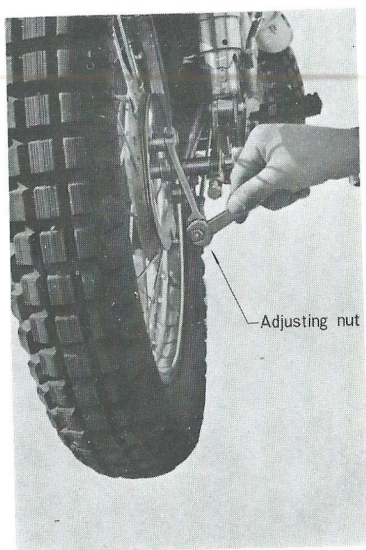
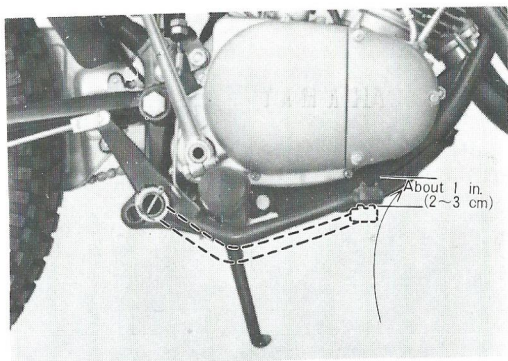

Note: This adjustment must be checked any time the chain is adjusted or the rear wheel is removed.

Checking the Brake Lining:

Disassemble the wheel assembly every 3,000 miles (5,000 km), check it for wear and clean the brake shoe and brake drum. Take care not to get any oil on the lining friction surface.

Adjusting the Clutch

The clutch lever should have .080 to .120 in. (2 to 3 mm) free play to maintain full pressure against the clutch facing. If the play is excessive, the clutch will not disengage. If the free play is insufficient, the clutch will slip.

How to Adjust the Clutch:

To adjust the clutch, turn the adjusting bolt attached to the clutch lever holder. After the adjustment, fully tighten the lock nut(s).

Precision Adjustment Method:

- Remove the clutch adjusting cover from the left side of the crankcase cover.
- Loosen the clutch adjusting screw (turn it to the left), and then tighten it slowly by turning it clockwise.
- Back it off $\frac{1}{4}$ turn from a lightly seated position, and lock it with the lock nut.
- Then adjust the play of the clutch cable with the adjusting bolt attached to the clutch lever holder.

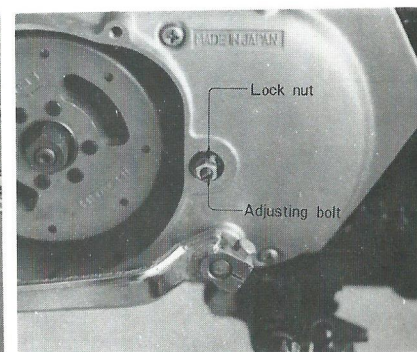
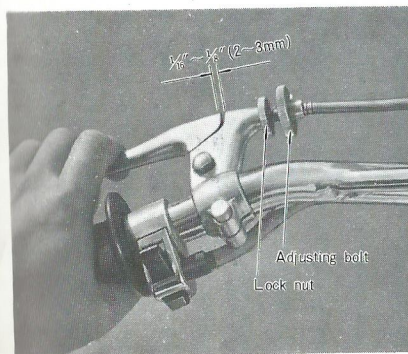

Replacing the Gear Oil

During the break-in period, replace the gear oil after 30 days from the date of purchase or after 300 miles (500 km) running.

After the first time, replacement should be made every three months or 1,200 miles (2,000 km).

To drain the oil from the bottom of the crankcase, remove the oil drain plug.

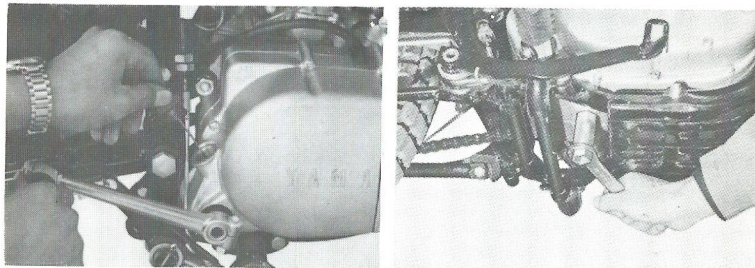

After draining the oil, fully tighten the oil drain bolt, and fill with new oil to the specified level.

OilSAE 10W/30 MOTOR OIL

Oil Amount0.7~0.8 quarts (0.7~0.8 litres)

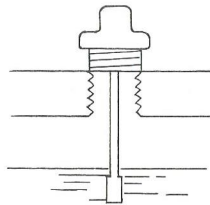
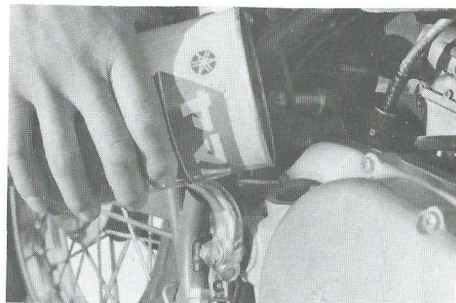

Checking the Battery electrolyte

If the battery electrolyte is below the minimum level, remove the battery and add distilled water.

Check the overflow pipe to make sure it is not clogged or pinched shut.

If your motorcycle will not be used for several months, remove the battery and keep it in dry, cool place, or have it kept in a service shop.

If stored for more than 60 days, it should receive an occasional recharge. Before reinstallation, it should be fully charged.

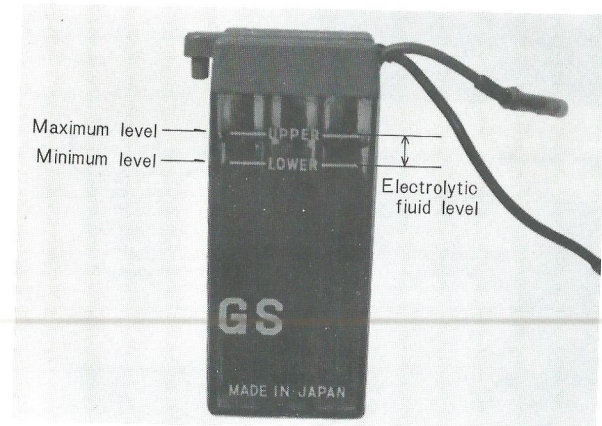

Checking the Spark Plug

A spark plug ignites the air-fuel mixture in the cylinder. A dirty plug causes hard starting, engine misfiring and other problems.

Clean carbon from the electrodes and adjust the point gap.

- Remove carbon build-up, with a wire brush or a wire.
- Adjust the spark plug point gap to 0.020~0.024 in. (0.5~0.6 mm).

Standard Spark Plug: B-8E

- Porcelain around the center electrode should be a light tan color.
- Replace the spark plug if the electrodes and porcelain are eroded or cracked. If your machine is frequently ridden at low speeds, the spark plug will become somewhat oily and sooty. Replace it with a hotter type.

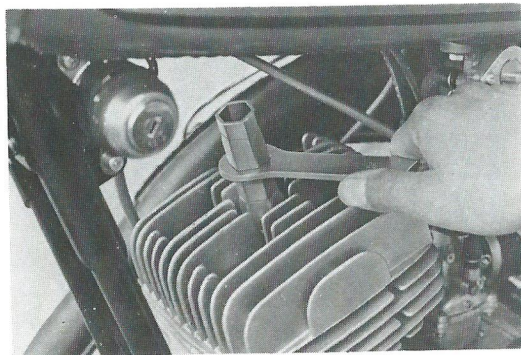
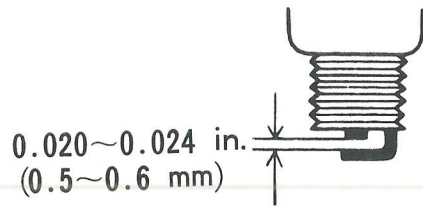

Cleaning the Air Cleaner

An air cleaner filters grit and other impurities from the air. If you often drive on dusty roads, be sure to clean it at least once a month.

- a) Remove the oil tank.

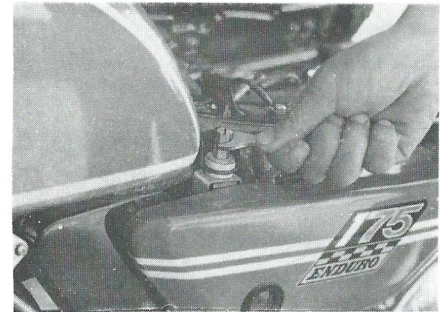

- b) Remove the air cleaner case cap fitting spring and cleaner case cap.



- c) The cleaner element can be pulled out.

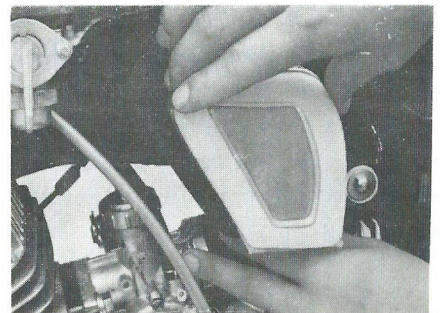

Checking the Carburetor

Each carburetor is set by the factory after careful tests. Except for the following, do not change the carburetor setting without consulting your local Yamaha dealer.

a. Idling Speed Adjustments

- Lightly tighten the pilot air screw ①, and then back it off it $1\frac{1}{2}$ turns.
- Slightly loosen the adjusting screw of the throttle cable ③ connected to the accelerator grip, and start the engine.
- After warming up the engine, turn the throttle stop screw ② so that engine speed increases to 1,200~1,300 rpm.
After this adjustment, loosen lock nut ⑤ to adjust the play of throttle cable ③ to $\frac{1}{32}$ in. (0.5~1.0 mm); and turn throttle cable adjuster ④ while pulling throttle cable ③ to check the adjustment. Then lock the throttle cable with lock nut ⑤.

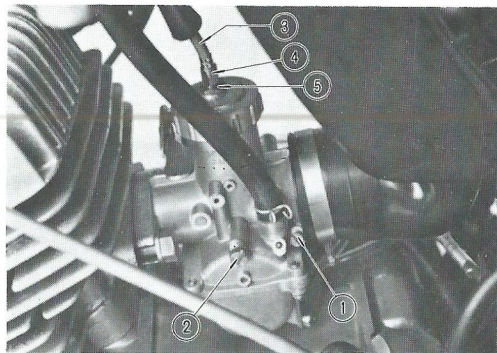

b. Adjusting the Pump Cable

After adjusting the carburetor, adjust the pump cable which is coupled with the throttle valve.

- Slightly turn the accelerator grip from the closed position so that free play of the accelerator grip is nil. (In other words, the throttle valve is ready to open, after only another slight turning of the throttle is needed.)

- Turn the pump cable adjusting nut so that the marking on the adjusting pulley is aligned with the guide pin.

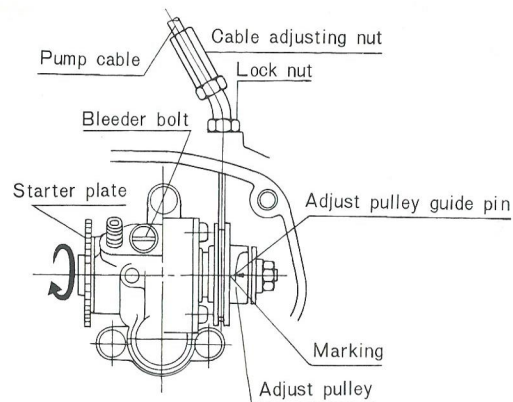

Adjusting the Drive Chain

The drive chain should have approximately $1\frac{1}{4}$ in. (30 mm) up and down play at the center of the lower section with the rear wheel on the ground. Since a dirty chain causes excessive sprocket wear, apply oil at regular intervals. In addition, wash it in gasoline before oiling at every periodic inspection.

Adjusting Chain Tension:

- a. Loosen the rear brake adjusting screw.
- b. Loosen the tension bar nuts.
- c. Loosen the rear axle nuts ①.
- d. Loosen the chain adjusting bolt lock nuts ②, and shift the wheel shaft so that both ends of the wheel shaft are positioned evenly by utilizing the marks on the swing arms.
- e. After adjusting, tighten the tension bar lock nuts ②, and axle nut ①.
- f. Adjust the play of the brake pedal.

*After these adjustments, check the play of the brake pedal and stoplight operation.

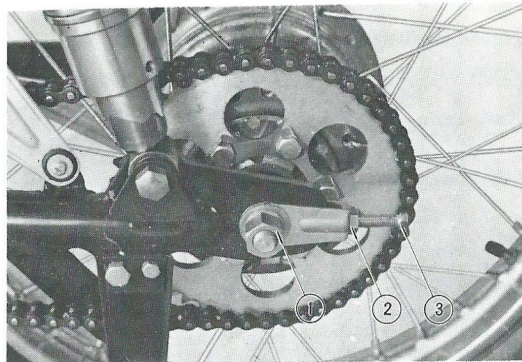

Cleaning the Muffler

To remove the inner cylinder from the muffler, remove the set screw and pull out the tail pipe.

Remove carbon with a wire brush.

Check the inner bore for carbon. If it is clogged, clean it with a wire.

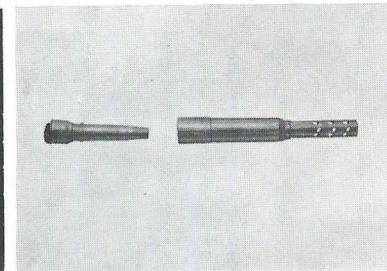
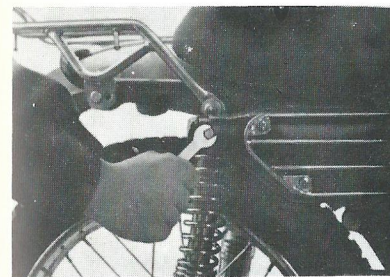

Cleaning the Combustion chamber and Piston

Carbon accumulation covering the combustion chamber and piston will result in loss of power, engine knock, overheating, and other problems.

a. Remove the cylinder head and remove carbon from the combustion chamber.

b. Remove carbon from the piston head.

To clean them, use a scraper and rags dampened with solvent.

c. The head bolts must be torqued when the head is reinstalled. Torque the bolts in pattern to a setting of 180 in/lbs.

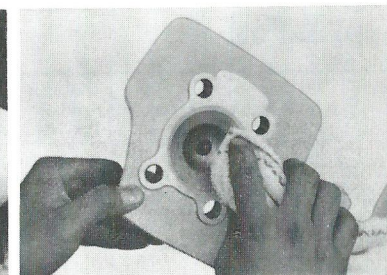
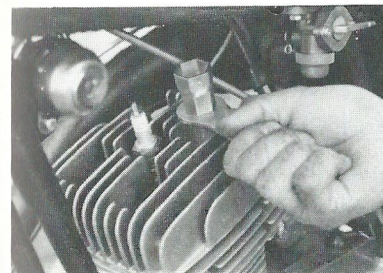

Cleaning the Fuel Cock Filter

The fuel cock filter removes impurities from gasoline before they flow into the carburetor. A dirty filter clogs the system, and as a result, the engine will not run properly. Clean it from time to time. Remove the cup from the fuel cock and remove the filter.

Wash it carefully in gasoline and reinstall.

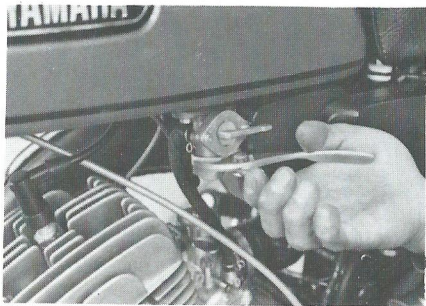

Retightening Screws, Bolts and Nuts

Check the screws, bolts and nuts in the parts listed below and retighten them if necessary.

Front and rear wheels	Engine mountings
Foot rests	Carburetor
Swing arm shaft	Air cleaner cover
Muffler	Exhaust nuts
Side stand	Rear cushion
	Handlebars

Greasing and Oiling

	Parts to be lubricated	Distance of driving at 1st lubr., miles	Lubrication interval, miles	Type of Lubricant
1	Front brake cam shaft	600	2,000	cup grease
2	Rear brake cam shaft	600	2,000	☺
3	Front brake cable	600	2,000	motor oil
4	Rear brake rod	600	2,000	cup grease
5	Accelerator grip	600	2,000	☺

6	Stand shaft	600	2,000	cup grease
7	Brake linkage	600	2,000	☺
8	Drive chain	300	600	motor oil
9	Gear oil	300	1,200	motor oil
10	Swinging arm shaft	600	2,000	cup grease

MEMO

Horizontal dashed lines for writing on page 38.

MEMO

Horizontal dashed lines for writing on page 39.

MEMO

Dotted lines for writing.

MEMO

Dotted lines for writing.

MEMO

.....

.....

.....

.....

.....

.....

.....

.....

.....

.....

.....

.....

.....

.....

.....

.....

.....

.....

.....

.....

.....

.....

.....

MEMO

.....

.....

.....

.....

.....

.....

.....

.....

.....

.....

.....

.....

.....

.....

.....

.....

.....

.....

.....

.....

.....

.....

MEMO

A series of horizontal dotted lines for writing, spanning the width of the page.



WIRING DIAGRAM

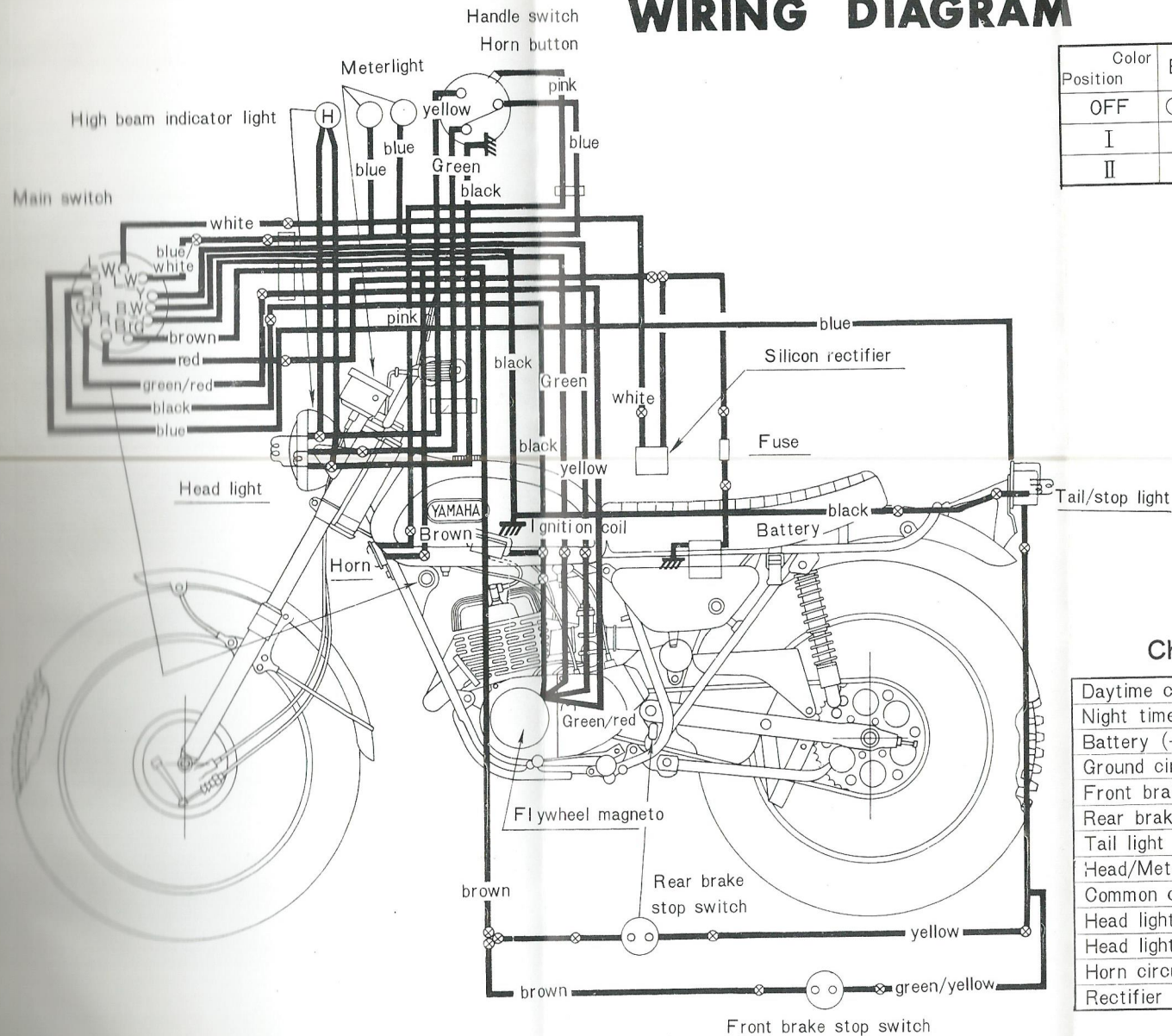

Color Position	E	B	R	Br	L	G	W	GR	LW	Y
OFF	○	○								
I			○	○		○	○			
II			○	○	○		○	○	○	○

Chart of wire colors

Daytime charging circuit	Green
Night time charging circuit	Green/Red
Battery (+) circuit	Red
Ground circuit	Black
Front brake stop light circuit	Green/Yellow
Rear brake stop light circuit	Yellow
Tail light circuit	Blue
Head/Meter light circuit	Blue(L.W)
Common circuit	Brown
Head light main circuit	Yellow
Head light sub circuit	Green
Horn circuit	Pink
Rectifier circuit	White