

**YAMAHA**

B 8E  
1.8 mm

**SERVICE MANUAL HT1-B**

**HT1  
- B**



**YAMAHA MOTOR CO., LTD.**

**NOTICE**

This manual has been written by Yamaha Motor Company for use by Authorized Yamaha Dealers and their qualified mechanics. In light of this purpose it has been assumed that certain basic mechanical precepts and procedures inherent to our product are already known and understood by the reader.

Without such basic knowledge, repairs or service to this model may render the machine unsafe, and for this reason we must advise that all repairs and/or service be performed by an Authorized Yamaha dealer who is in possession of the requisite basic product knowledge.

Other information is produced by the U.S. distributor, Yamaha International Corporation, and is necessary to provide total technical coverage regarding the product.

\*\*\*\*\*

The Research, Engineering, and service Departments of Yamaha are continually striving to further improve all models manufactured by the company. Modifications are therefore inevitable and changes in specifications or procedures will be forwarded to all Authorized Yamaha Dealers and will, where applicable, appear in future editions of this manual.

\*\*\*\*\*

**YAMAHA (HT1-B) SERVICE MANUAL**

**1st Edition**

**AUGUST 1970**

**SERVICE DEPARTMENT**

**YAMAHA MOTOR COMPANY**

**HAMAMATSU, JAPAN**

## FOREWORD

*The Yamaha 90HT1-B is originally designed for off-the-road riding as a trials machine or a scrambler, but it is also built to EXCEL in high speed performance over the road or highways.*

*This manual is offered so that all Yamaha dealers and service engineers will become familiar with the technical information and service instructions essential to the HT1-B.*



YAMAHA MOTOR CO., LTD.  
DEPARTMENT DIVISION

## CONTENTS

CHAPTER 1. GENERAL .....	1
1-1 Profile .....	1
1-2 Features of Yamaha 90HT1-B .....	2
1-3 Specifications & Performance HT1-B .....	3
1-4 Performance Curves .....	5
1-5 Tools and Instruments for Shop Service .....	6
CHAPTER 2. YAMAHA AUTOLUBE (Automatic. Separate Lubricating System) .....	8
2-1 What is YAMAHA Autolube? .....	8
2-2 Features of YAMAHA Autolube .....	8
2-3 Handling the Oil Pump .....	9
CHAPTER 3. 5-PORT CYLINDER INDUCTION SYSTEM .....	12
3-1 Description of 5-Port Cylinder Induction System .....	12
3-2 Construction and Design of the 5-Port Induction System .....	12
CHAPTER 4. ENGINE .....	13
4-1 Engine Removal .....	13
4-2 Cylinder Head .....	16
4-3 Cylinder .....	16
4-4 Piston Pin .....	18
4-5 Piston Ring .....	19
4-6 Piston .....	20
4-7 Flywheel Magneto .....	21
4-8 Crankcase Cover (R.H.) .....	22
4-9 Clutch .....	23
4-10 Primary Drive Gear .....	27
4-11 Kick Starter Mechanism .....	28
4-12 Shift Mechanism .....	30
4-13 Drive Sprocket .....	32
4-14 Crankcase .....	33
4-15 Transmission Assembly .....	35
4-16 Crankshaft .....	38
4-17 Bearings and Oil Seals .....	41
4-18 Carburetor .....	42
4-19 Air Cleaner .....	44

CHAPTER 5.	CHASSIS.....	46
5-1	Front Wheel.....	46
5-2	Rear Wheel.....	50
5-3	Rear Sprocket Wheel.....	53
5-4	Tires and Tubes.....	54
5-5	Front Forks.....	54
5-6	Rear Shocks.....	57
5-7	Gas Tank.....	58
5-8	Rear Swing Arm.....	58
5-9	Steering Head.....	60
5-10	Oil Tank, Battery Box and Tool Box.....	61
5-11	Frame .....	61
5-12	Handlebars.....	61
5-13	Miscellaneous.....	61
CHAPTER 6.	ELECTRICAL SYSTEM.....	62
6-1	Description.....	62
6-2	Table of Component Parts .....	62
6-3	Connection Diagram.....	62
6-4	Ignition System-Function and Service.....	63
6-5	Ignition Timing.....	63
6-6	Ignition Coil.....	63
6-7	Condenser .....	63
6-8	Charging System.....	64
6-9	Battery .....	65
6-10	Checking the Main Switch (removed from the chassis) .....	66
6-11	Spark Plug .....	66
6-12	Lighting and Signal Systems.....	67

CHAPTER 1. GENERAL

1-1 Profile

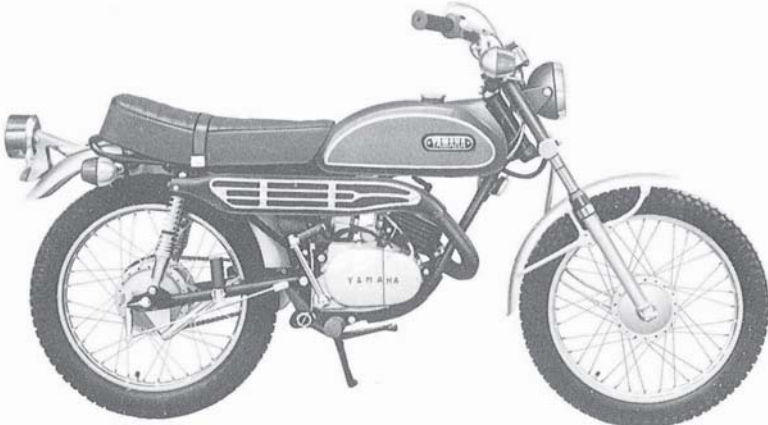

**1-2 Features of Yamaha 90HT1-B**

**1. High-performance Single Cylinder Engine**

The Yamaha 90HT1-B utilizes a powerful two-stroke 89 cc engine. The new five-port cylinder, which is another Yamaha technical development, greatly improves engine efficiency and is responsible for high power output throughout a broad RPM range.

**2. Highly-dependable Yamaha Autolube**

Yamaha Autolube provides superior engine lubrication that extends the life of the engine.

**3. Easy Starting**

The engine can be started by simply disengaging the clutch and kicking the kick pedal without shifting gears back to neutral. This is a valuable convenience to the rider. The HT1-B is equipped with a magneto. To start the engine, kick the kick pedal.

**4. Powerful Brakes**

Patented waterproof, dustproof brake drums provide safe, fade-free braking on wet or dusty roads.

**5. Adjustable Rear Cushion**

The rear cushions are adjustable for five positions. The rider can adjust spring tension to compensate for varying weight, speed, and road conditions.

**6. Front Fork Design**

The Yamaha 90HT1-B employs a front fork design well-known for its strength and superior handling characteristics. Its use assures the rider of the ultimate suspension for even the roughest terrain.

**7. Tires**

The YAMAHA HT1-B is fitted with tires having a universal type tread pattern as standard equipment. This particular tread is one of the most versatile available. It gives maximum trail traction and yet is compatible with road usage.

**8. Carburetor Starter Feature**

Yamaha's starter feature is already well-known for its easy starting. Equipped with this unique carburetor, the Yamaha HT1-B is quick starting under all conditions.

### 1-3 Specifications & Performance HT1-B

Model	YAMAHA 90HT1-B
<b>Dimensions:</b> Overall length Overall width Overall height Wheelbase Min. ground clearance	73.8 in (1,875 mm) 35.4 in ( 900 mm) 40.7 in (1,035 mm) 48.0 in (1,220 mm) 8.9 in ( 225 mm)
<b>Weight:</b> Net Gross	190 lbs. (86 kg) 201 lbs. (91 kg)
<b>Performance:</b> Max. speed Fuel consumption (on paved level roads) Climbing ability Min. turning radius Braking distance	55 m/h (95 km/h) 164.5 mpg at 25 mph (70 km/lit./40 km/h) 25 degrees 68.9 in (1,750 mm) 23.0 ft at 22 mph (7.0 m/35 km/h)
<b>Engine:</b> Model Type Lubricating system  Cylinder Displacement Bore & Stroke Compression ratio Max. power Max. torque Starting system Ignition system Ignition timing	HT1-B 2 stroke, gasoline Separate lubrication (YAMAHA Autolube)  Single, forward inclined, 5-port 5.43 cu.in. (89 cc) 1.969 x 1.795 in (50 x 45.6 mm) 6.8 : 1 8.5 HP/7,000 rpm 6.51 ft.lbs./6,500 rpm (0.9 kg-m/6,500 rpm) Primary kick starter Magneto ignition 1.8 mm B.T.D.C.
<b>Carburetor:</b> Type M.J. J.N.	VM20SC #85 4D3-3 Stages
<b>Air cleaner:</b>	Wet, foam rubber
<b>Transmission:</b> Clutch Primary reduction system Primary reduction ratio	Wet, multiple-disk Gear 3.894 (74/19)



**GENERAL - Specifications & Performance HT1-B**

Model	YAMAHA 90HT1-B
Gear box: Type Reduction ratio 1st Reduction ratio 2nd Reduction ratio 3rd Reduction ratio 4th Reduction ratio 5th Secondary reduction system Secondary reduction ratio	Constant mesh, 5-speed forward 3.182 (35/11) 2.000 (30/15) 1.368 (26/19) 1.000 (23/23) 0.800 (20/25) Chain 3.500 (49/14)
Chassis: Frame Suspension system, front Suspension system, rear Cushion system, front Cushion system, rear	Tubular-Double loop Telescopic fork Swinging, arm Coil spring, oil damper Coil spring, oil damper
Steering system: Caster Trail	60.5° 4.3 in (110 mm)
Braking system: Type of brake Operation system, front Operation system, rear	Internal expansion Right hand operation Right foot operation
Tire size: Front Rear	2.75-18-4PR 3.00-18-4PR
Flywheel magnet Model Manufacturer	F130-07 HITACHI Ltd.
Battery: Model Manufacturer Capacity	6N2-2A-3 FURUKAWA Battery 6V 2AH
Lighting: Head light Tail light Stop light Meter light Flasher light High beam indicator light	6V . 25W/25W 6V . 5.3W 6V . 17W 6V . 3W 6V . 17W 6V . 1.5W
Tanks: Gasoline tank capacity Oil tank capacity	1.7 US gals. (6.5 liters) 1.3 qts. (1.2 liters)

1.4 Performance Curves

ENGINE PERFORMANCE CURVES

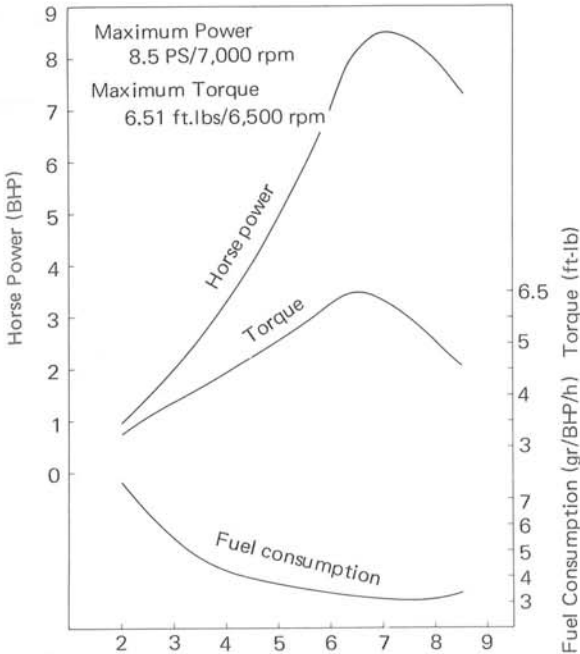

DRIVING PERFORMANCE CURVES

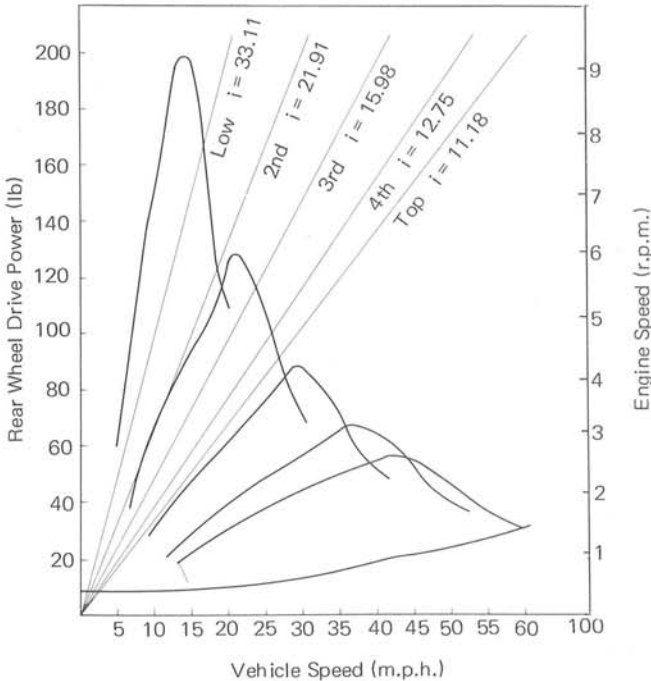

### 1-5 Tools and Instruments for Shop Service

The following tools and instruments are required to service the HT1-B

#### 1. General Tools

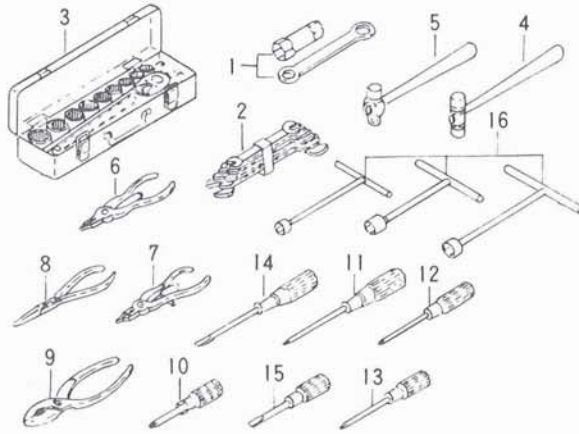

- |                             |                                   |
|-----------------------------|-----------------------------------|
| 1. Plug wrench 23 x 29 mm.  | 9. Pliers                         |
| 2. A set of wrenches        | 10. Phillips-head screwdriver     |
| 3. A set of socket wrenches | 11. Phillips-head screwdriver (L) |
| 4. Plastic tip hammer       | 12. Phillips-head screwdriver (M) |
| 5. Steel hammer             | 13. Phillips-head screwdriver (S) |
| 6. Circlip pliers (ST type) | 14. Slot-head screwdriver (M)     |
| 7. Circlip pliers (TR type) | 15. Slot-head screwdriver (S)     |
| 8. Needle nose pliers       | 16. T-handle socket wrench        |

Fig. 1-5-1

#### 2. Special Tools and Instruments

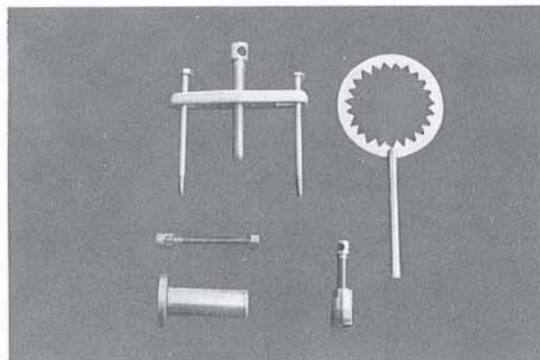

1. Clutch holding tool
2. Crankcase disassembling tool
3. Crankshaft assembling tool
4. Flywheel magneto holding tool
5. Flywheel magneto puller

Fig. 1-5-2

In addition, an electro-tester, tachometer (engine rpm meter), hydrometer, etc. will be furnished.

3. Other Materials

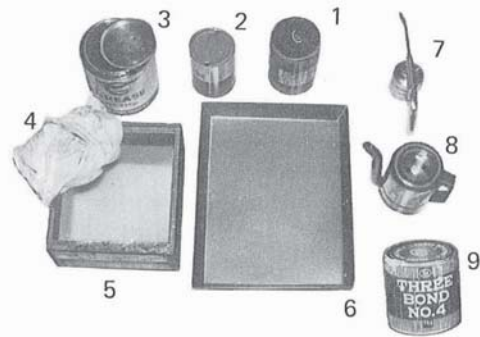

- |                                   |                      |
|-----------------------------------|----------------------|
| 1) Grease                         | 6) Parts tray        |
| 2) Autolube oil                   | 7) Oiler             |
| 3) Yamaha Bond (No. 5)            | 8) Oil jug           |
| 4) Wiping material                | 9) Yamaha Bond No. 4 |
| 5) Overhauling stand (Wooden box) |                      |

Fig. 1-5-3

The use of a wooden box as shown in the above photo will facilitate engine service and overhaul. Consumable parts (such as gaskets) and replacement parts must also be on hand.

## CHAPTER 2. YAMAHA AUTOLUBE (Automatic, Separate Lubricating System)

### 2-1 What is YAMAHA Autolube?

Conventional 2-stroke engines are lubricated by oil premixed in gasoline, but YAMAHA's Autolube furnishes an automatic, separate lubrication system. That is, the oil in a separate oil tank is automatically regulated by the oil pump and fed to the engine according to engine speed and load.

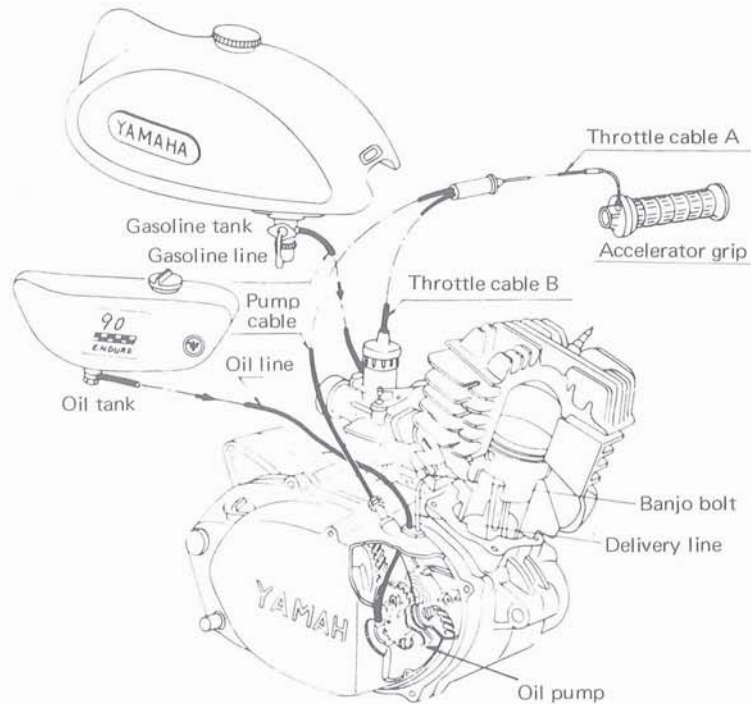

Fig. 2-1-1

### 2-2. Features of YAMAHA Autolube

The oil pump is driven by the engine through a reduction gear, and is connected to the carburetor throttle cable, which in turn is controlled by the accelerator grip. The oil pump automatically regulates the volume of lubricating oil according to engine speed and throttle valve opening, thus pumping the optimum amount of oil for engine lubrication under any operating condition.

This "automatic, separate lubrication" does not merely eliminate disadvantages in the conventional pre-mix system, but it further improves the performance and efficiency of 2-stroke designs by eliminating certain oil-starvation conditions which formerly existed.

- A) The Autolube feeds an optimum amount of lubricating oil to the engine under any operating condition, thus featuring:
  - Less oil consumption.
  - Less carbon accumulation.
  - Less exhaust smoke.
  - Improved lubricating efficiency.
- B) The Autolube simplifies fuel supply, thus featuring:
  - Using straight gasoline directly in the gas tank.
  - Less fuel contamination.
- C) The Autolube improves the reliability of lubrication, thus eliminating:
  - Special care concerning oil/fuel mixing ratio.

## 2-3. Handling the Oil Pump

The oil pump is a precision-machined assembly. Make no attempt to disassemble it. When you remove the oil pump from the engine, protect it from dust, dirt, etc., and after reinstalling it, bleed and adjust the pump correctly. Proper handling will keep the pump free from trouble.

The oil pump is similar in both construction and operation to other Autolube systems. The only difference is the employment of a 5.5ϕ plunger because of larger consumption of oil by a 90 cc single cylinder engine.

### 2-3-A. Checking Minimum Pump Stroke

#### 1. Checking

- a. Fully close the accelerator grip.

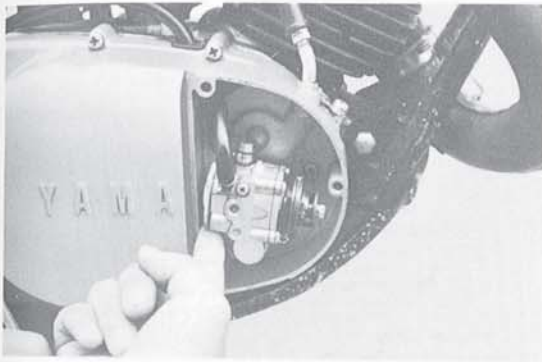

Fig. 2-3-1

- b. Turn the oil pump starter plate in the direction of the arrow marked on the plate. Then measure the gap between the adjustment pulley and the adjustment plate. Keep the gap as wide as possible by observing it with the eye.

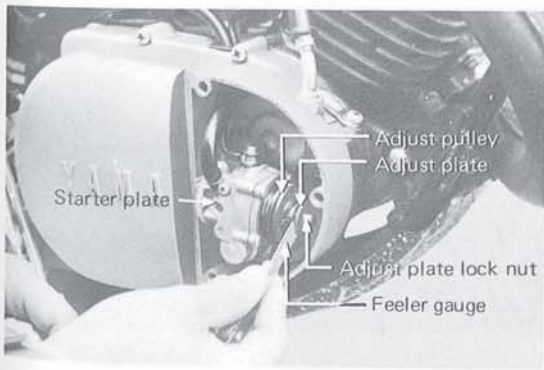

Fig. 2-3-2

- c. Insert a feeler gauge (0.15 mm.) into the gap.

When the gap allows it to enter  
..... Stroke is correct.

When the gap does not allow  
..... Stroke is insufficient.

#### 2. Adjustment

- a. Remove the adjustment plate lock nut, and then remove the adjustment plate.

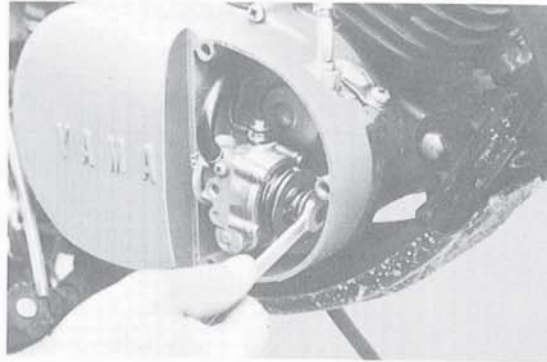

Fig. 2-3-3

- b. Install a 0.1 mm. adjustment shim where the adjustment plate was.

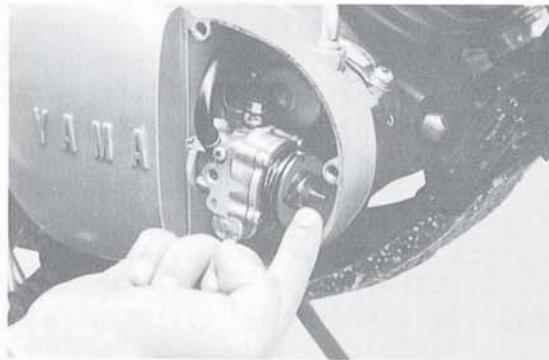

Fig. 2-3-4

- c. Reinstall the adjustment plate lock nut, and measure minimum stroke. When the gap allows a 0.20 mm. feeler gauge to enter but does not allow a 0.25 mm, the stroke is correctly adjusted. Stroke adjustment tolerance ..... 0.20 to 0.25 mm.

### 2-3-B. Carburetor and Autolube Cable Adjustments

Follow the preceding in section 2-3-A steps to check minimum stroke, and adjust it if incorrect. Then adjust the pump and carburetor as described in the steps below.

#### 1. Throttle Cable Adjustment

- a. Adjust the carburetor with the engine at idle, and remove all but 1 mm of slack from throttle cable B.

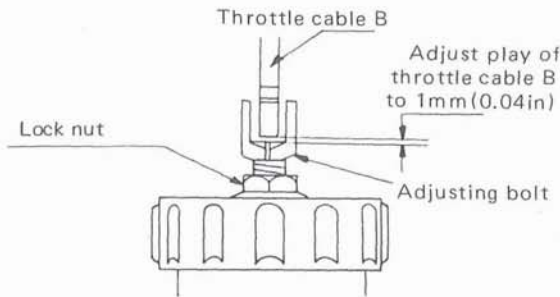

Fig. 2-3-5

- To bring the play of the throttle cable into correct adjustment, loosen or tighten the throttle cable adjustment screw.
  - To check this adjustment, lightly pull throttle cable B, and engine speed should slightly increase from idling r.p.m.
- b. Next, adjust throttle cable (A) so that the gap as shown in Fig. 2-3-6 below will be between 0.5 and 1.0 mm. (0.02~0.04 in.)

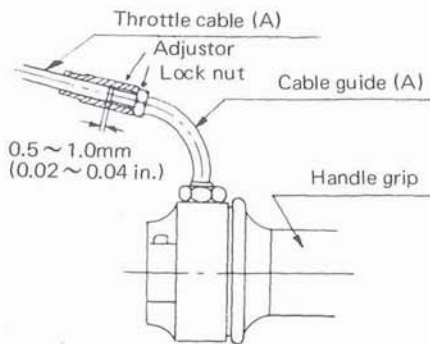

Fig. 2-3-6

- Check the play of the throttle cable (A) by pulling the outer part of the throttle grip. If the play is excessive or insufficient, adjust the play with the adjustment screw.

#### 2. Autolube Cable Adjustment

- a. Adjust the pump cable so that the marking (arrow) on the Autolube pump adjustment pulley is aligned with the guide pin (see Fig. 2-3-8). Begin by fully closing the accelerator grip, then slowly turning it back again so that the slack in the throttle cable is completely taken up. Next, adjust the pump cable so that the marking on the pump adjustment pulley will be aligned with the guide pin, as shown in Fig. 2-3-7. The point of adjustment is at the end of the cable, just before it enters the case. Loosen the lock nut and screw the adjuster in or out, whichever direction is necessary to obtain the correct adjustment.

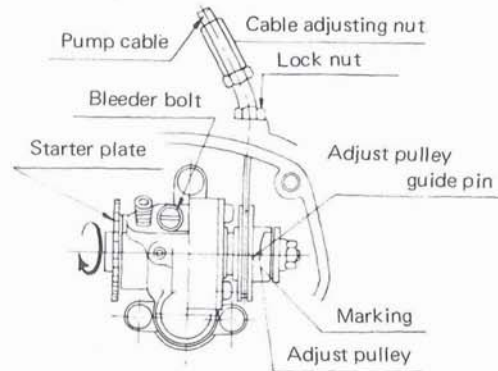

Fig. 2-3-7

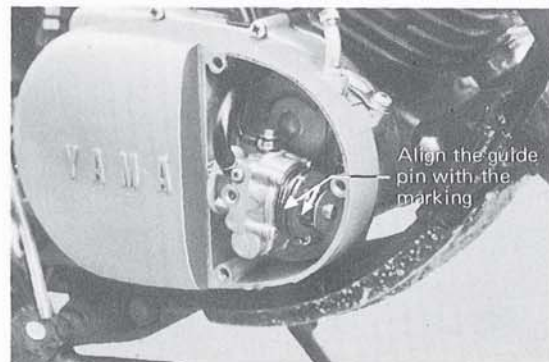

Fig. 2-3-8

### 2-3-C. Bleeding

When the pump has been removed or the Autolube oil has run out, air will enter the pump. The air will cause an irregular flow of oil after the pump is mounted again or the oil is refilled. In order to prevent such an irregular flow of oil, bleed the pump in the following manner.

1) Remove the bleeder bolt.

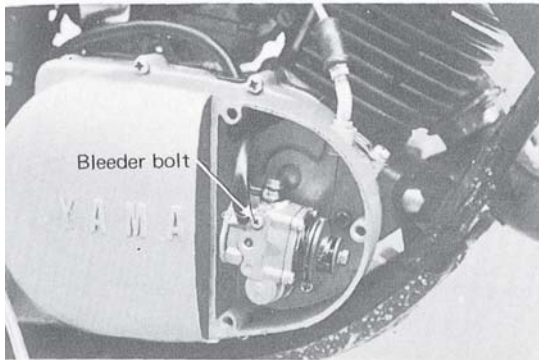

Fig. 2-3-9

2) Next, rotate the starter plate in the direction of the arrow marked on the plate. Continue turning the plate until no air comes out with the oil and tighten the bleeder bolt. To facilitate this bleeding, fully open the accelerator grip and rotate the starter plate. As the plunger stroke becomes greater, the air can be quickly bled.

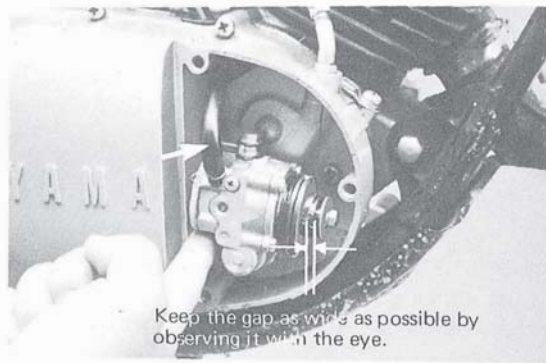

Fig. 2-3-10



### CHAPTER 3. 5-PORT CYLINDER INDUCTION SYSTEM

#### 3-1. Description of 5-Port Cylinder Induction System

The schnuerle loop scavenging system is the most commonly used induction system for the two-stroke engine. In the schnuerle loop system, two transfer ports on the right and left sides of the cylinder are employed to transfer 2 streams of fresh fuel in the loop design. This has proved to be the most effective induction system until the innovation of Yamaha's five-port cylinder. This conventional schnuerle loop system had a design limit in that the transfer ports could not be made large enough to completely clear the combustion chamber of exhaust gases because of the position of the intake and exhaust ports. This would result in a portion of exhaust gas remaining in the central area of the combustion chamber that would contaminate the fresh fuel charge.

The rotary valve induction system incorporates the use of a 3rd transfer port at the back of the cylinder that directs a fresh fuel charge to the dead area containing the remaining exhaust gases. But to incorporate the rotary valve system into the 90 cc single engine would result in physical design limitations of the engine. The physical limitations of excessive engine width and unattractive appearance restricts such an engine design. Yamaha's Research and Engineering Departments, therefore, designed and perfected the five-port cylinder induction system that is used on the HT1-B. This new five-port system, with the incorporation of two additional specially designed transfer ports, completely removes all the exhaust gases previously left in the dead area of the cylinder.

Engine performance is greatly increased with the use of this five-port system.

#### 3-2. Construction and Design of the 5-port Induction System

The 2 additional transfer passages are placed to the immediate rear of the standard transfer ports. These two additional ports run from the bottom of the cylinder up to the same height as the standard transfer ports. These additional ports are designed to direct the fresh charge at the area containing the remaining exhaust gases. As the fresh fuel charge enters the combustion area, the remaining exhaust gas is forced out the exhaust

port, thus leaving the combustion area with an uncontaminated, full, fresh fuel charge. Therefore, these additional transfer ports perform with equivalent efficiency the task so well done by the additional third port of the rotary valve induction system. This assures constant and equal performance, both at low engine speeds and high engine speeds.

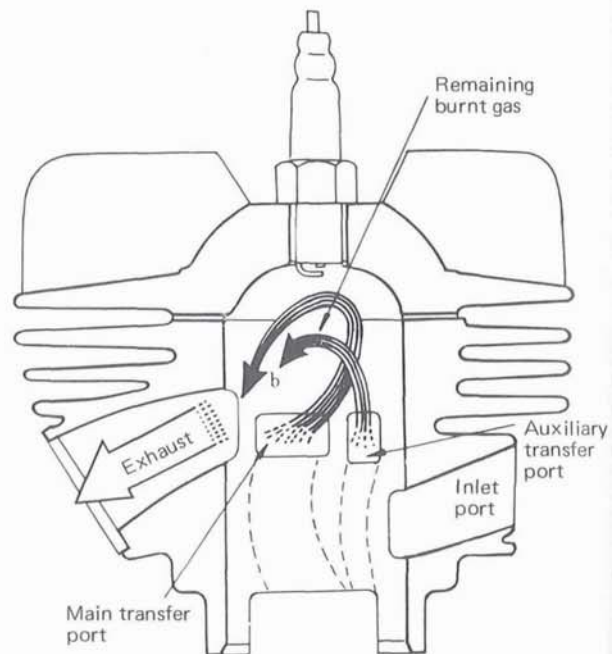

Fig. 3-2-1

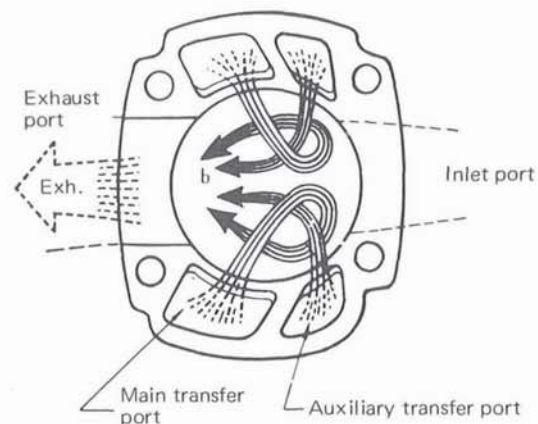

Fig. 3-2-2

## CHAPTER 4. ENGINE

This chapter describes the disassembly and re-assembly of the engine, its removal from the chassis, and the necessary service data. However, except when overhauling the crankshaft assembly, transmission, shifter mechanism, or bearings and oil seals in the crankcase, it is suggested that engine be serviced without removing it from the chassis. This will save a lot of time and labor.

**Preparation for disassembly of the engine:**

- 1) All dirt, mud, dust, and foreign material should be thoroughly removed from the exterior of the engine assembly before removal and disassembly. This will prevent any harmful foreign material from entering the interior of the engine assembly.
- 2) Before engine removal and disassembly, be sure you have proper tools and cleaning equipment so you can perform a clean and efficient job.
- 3) During disassembly of the engine, clean all parts and place them in trays in order of disassembly. This will make assembly time faster and easier, and insure correct installation of all engine parts.

**4-1. Engine Removal**

1. Start the engine and warm it up for a few minutes, then turn off the engine and drain the transmission oil. (Fig. 4-1-1)

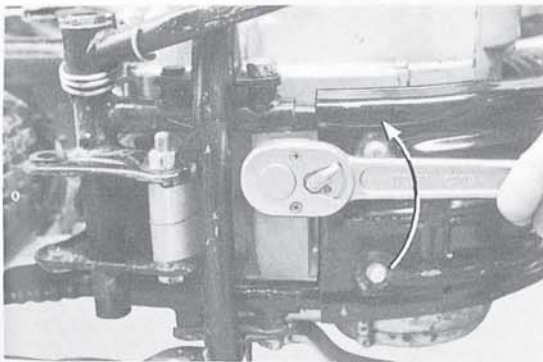

Fig. 4-1-1

Volume of oil: 650~750 c.c. (0.69~0.79 US qt.)

(SAE10W/30)

2. Remove the muffler.
  - 1) Remove the one spring. (Figs. 4-1-2 and 3)

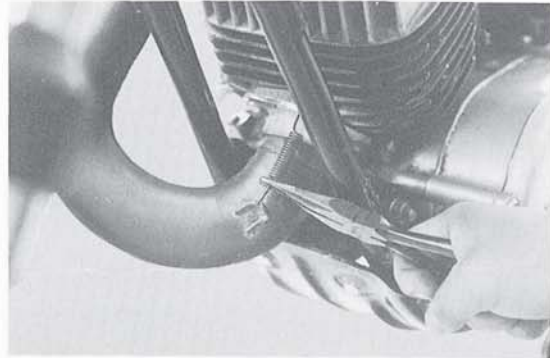

Fig. 4-1-2

- 2) Remove the muffler holding bolts. (Fig. 4-1-4)

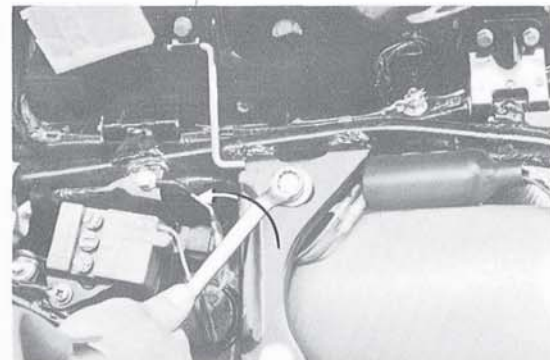

Fig. 4-1-3

3. Remove the change pedal.

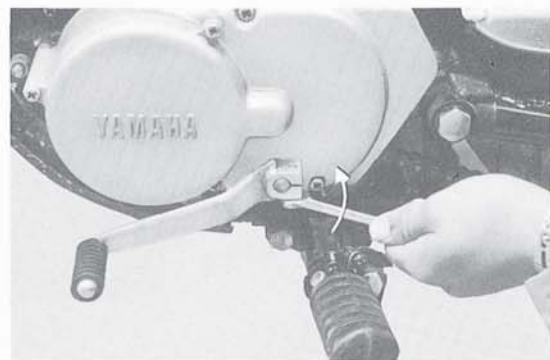

Fig. 4-1-4

## ENGINE - Engine Removal

4. Remove the lefthand crankcase cover.

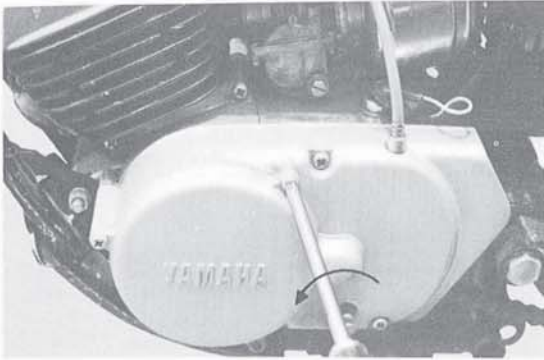

Fig. 4-1-5

5. On the HT1-B, equipped with a flywheel magneto, the wiring should be disconnected from the wire harness center at its connector. (Fig. 4-1-6)

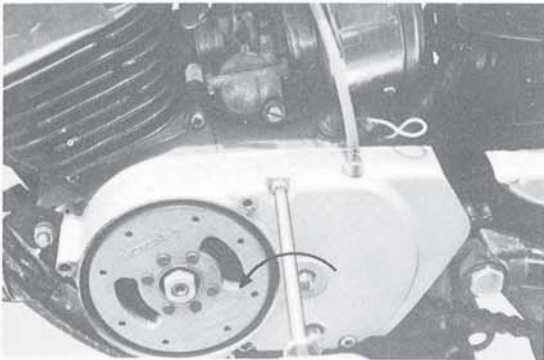

Fig. 4-1-6

6. Disconnect the master link and remove the chain.

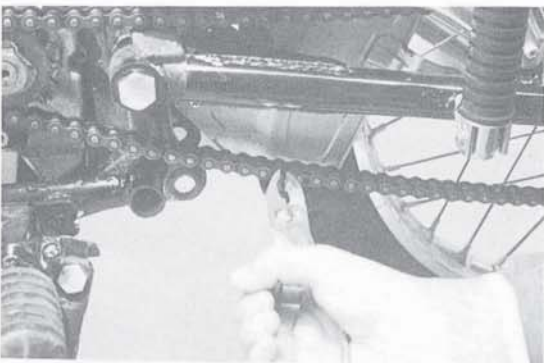

Fig. 4-1-7

When reconnecting the chain be sure the master link is facing in the correct direction.

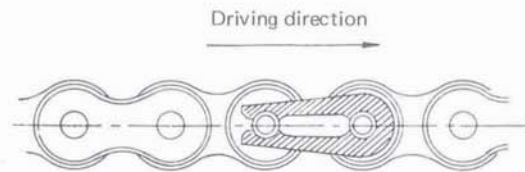

Fig. 4-1-8

After reconnecting the chain adjust the free play to 25 mm. (1 in.) up and down at the center of the lower section with the rear wheel on the ground.

7. Remove the pump cover and pump cable.

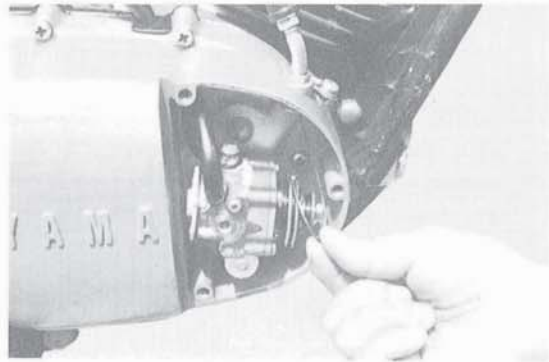

Fig. 4-1-9

8. Remove the air cleaner ass'y.

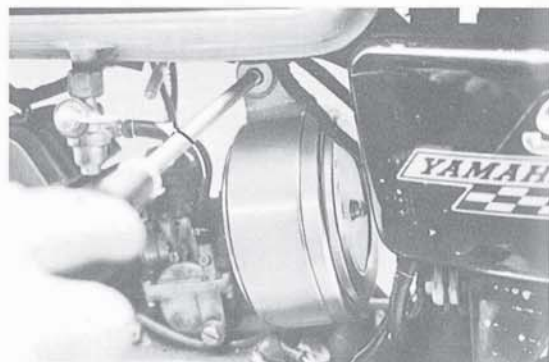

Fig. 4-1-10

9. Disconnect the oil line and be sure to plug the hole to prevent oil from flowing out.

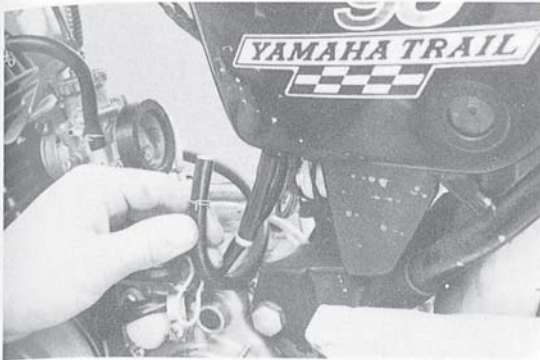

Fig. 4-1-11

10. Disconnect the fuel line at the bottom of the fuel tank.

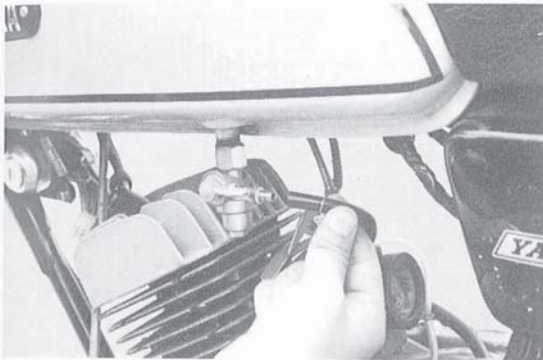

Fig. 4-1-12

11. Remove the engine mounting bolts.

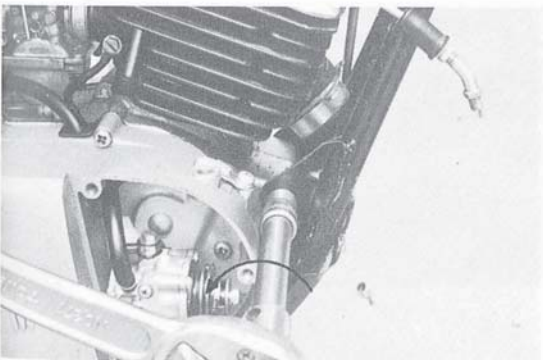

Fig. 4-1-13



Fig. 4-1-14

12. Remove the engine from the frame.

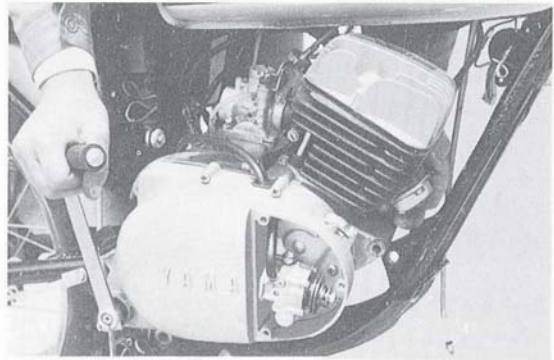

Fig. 4-1-15

### 4-2. Cylinder Head

The cylinder head is bolted on the cylinder with special nuts.

#### A. Removing

Remove the four special nuts from the top of the cylinder head, then the head and head gasket. Reverse the sequence for reinstallation. Replace the gasket, if damaged. Cylinder head tightening torque is 15~18 ft-lbs. (2.0 kg-m).

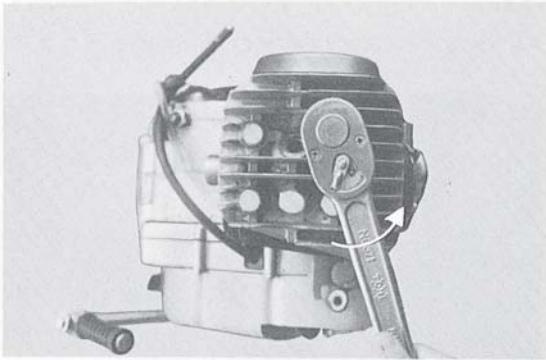

Fig. 4-2-1

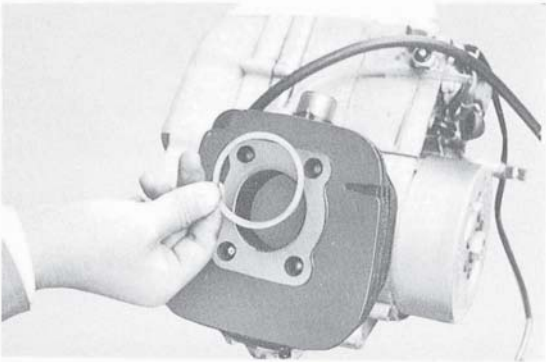

Fig. 4-2-2

#### B. Removing Carbon Deposits

Carbon deposits on the cylinder head combustion chamber and top of the piston will result in an increase in the compression ratio, as well as preignition and engine overheating. Scrape the cylinder head and piston dome clean.

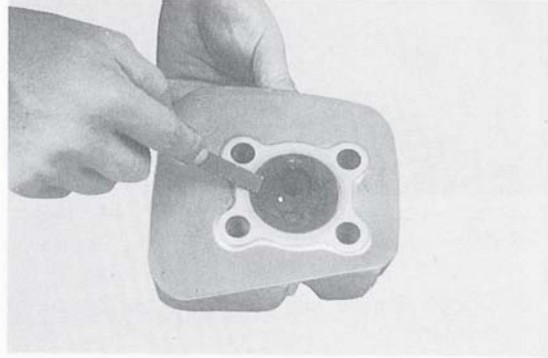

Fig. 4-2-3

### 4-3. Cylinder

The Yamaha 90HT1-B engine employs a special cast iron cylinder.

The cylinder is of 5-port design with superior scavenging efficiency.

#### A. Removing the Cylinder

- 1) Remove the oil delivery line banjo bolt from cylinder.

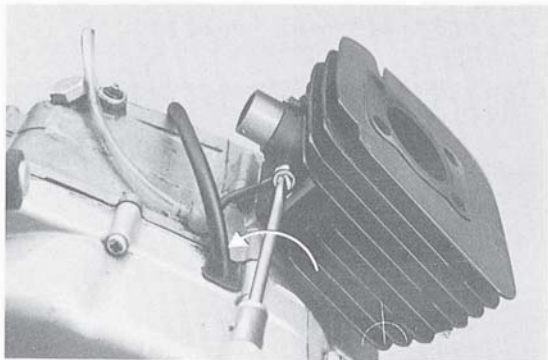

Fig. 4-3-1

- 2) Remove the cylinder by striking it lightly with a plastic or rubber hammer.



Fig. 4-3-2

- 3) Always replace the cylinder base gasket when reassembling.

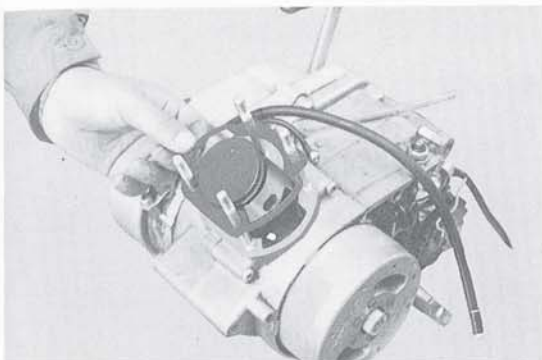

Fig. 4-3-3

#### B. Checking the Cylinder for Wear

- 1) Measure the amount of wear of the cylinder wall with a cylinder bore measuring micrometer or cylinder gauge. (Measure it at four depths while positioning the instrument at right angles to the crankshaft.) If the difference between the maximum and minimum diameter exceeds 0.05 mm. (0.0019"), rebore and hone the cylinder.

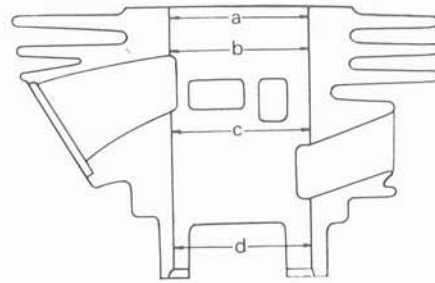
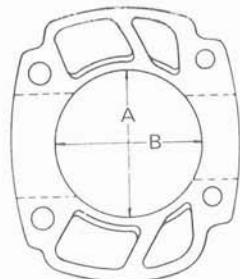

Fig. 4-3-4

- 2) The minimum clearance between the piston and the cylinder is 0.040~0.045 mm. (0.0016" and 0.0018")

#### C. Cylinder Reconditioning

- 1) Pistons are available in 0.25 and 0.50 mm. (0.010" and 0.020") oversizes.
- 2) The cylinder should be rebored and honed to the diameter of the oversize piston plus the minimum allowable clearance. (4-3-B-2.)
- 3) The error between the maximum and minimum diameters after honing should be no more than 0.04 mm. (0.0015")

#### D. Removing Carbon Deposits

Scrape off the carbon accumulation in the exhaust port of the cylinder with the dulled end of a hacksaw blade.



Fig. 4-3-5

**E. Installing the Cylinder**

Put your fingers at each end of the piston ring, expand the ring, and slip it onto the piston. Align both ends of the ring with the knock pin in each ring groove. Next, insert the piston into the cylinder. Take care not to damage the bottom of the cylinder with the rings.

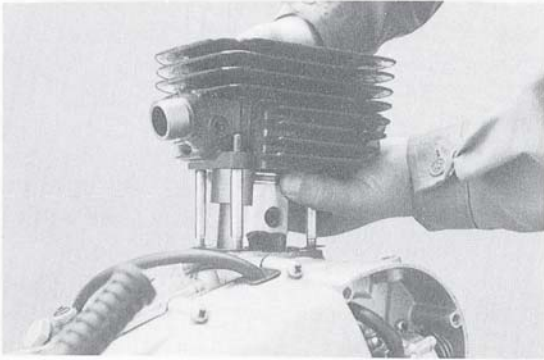

Fig. 4-3-6

**4-4. Piston Pin**

**A. Pulling out the Piston Pin**

Remove the clips at one end of the piston pin with needle nose pliers, and press out the piston pin with a finger or a slot-head screw driver.

**Note:**

Before removing the piston pin clips, cover the crankcase with a clean rag, so you will not accidentally drop the clip or other foreign particles into the crankcase.

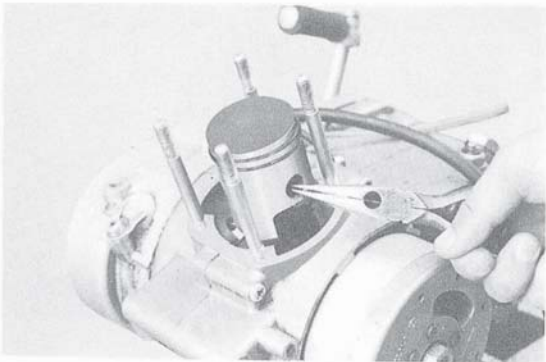

Fig. 4-4-1

**B. Piston-to-Piston pin Fit**

The piston pin should fit snugly in its bore so that it drags a little as you turn it. If the piston pin is loose, replace the pin and/or the piston.

If the pin has step-wear in its center, replace the needle bearing as well as the piston pin. Check the small end of the connecting rod for wear by inserting the piston pin and bearing.

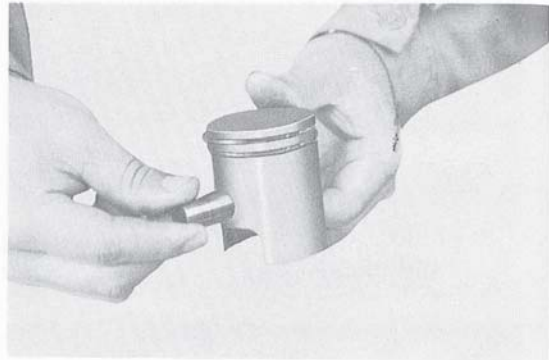

Fig. 4-4-2

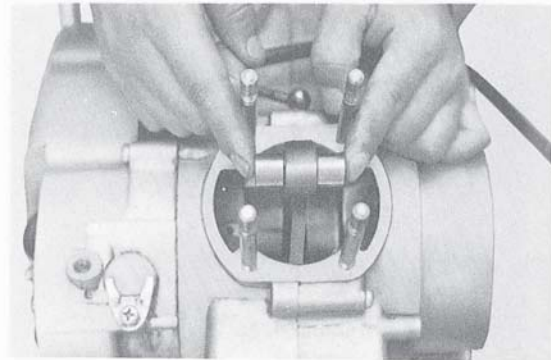

Fig. 4-4-3

**4-5. Piston Ring**

**A. Removing the Piston Rings**

Put your thumbs at each end of the piston ring and pull the piston ring ends apart. Remove the ring by moving the ring off the piston on the other side of the ring ends.

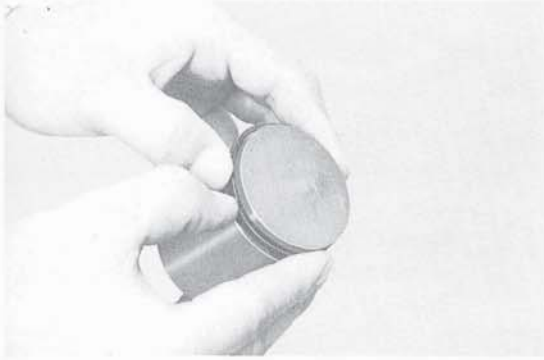

Fig. 4-5-1



Fig. 4-5-2

**B. Installing the Piston Rings**

First fit No.2 ring over the piston, and then the No.1 ring, and align their end gaps with the locating pin in each ring groove. (Fig. 4-5-3)

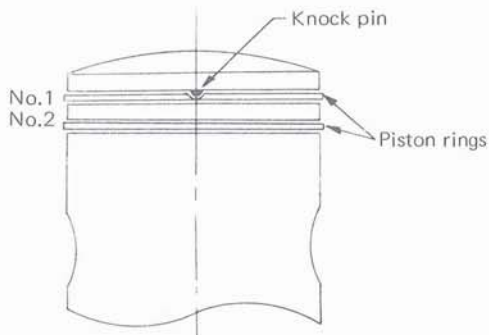

Fig. 4-5-3

The printing on all rings must face up to position the gap properly at the pin.

**C. Checking the Piston Rings**

1) Measuring piston ring wear

Put the ring into the cylinder so that the ring is parallel to the cylinder bottom edge, and then measure the end gap with a feeler gauge (Fig. 4-5-4).

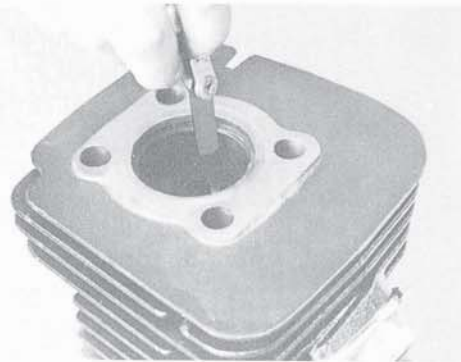

Fig. 4-5-4

The end gap should be between 0.15 and 0.35 mm. (0.006"~0.014") for both No.1 and No.2 rings.

2) Removing carbon

Carbon on the piston rings and in the ring grooves will make the rings stick in the piston, thus causing gas blow-by.

Remove the rings from the piston, and clean the carbon from the rings and ring grooves.



### 4-6. Piston

The piston is made of a high-silicon aluminum alloy.

#### A. Checking and Correcting the Piston to Cylinder Wall Clearance

##### 1) Measuring piston clearance

Piston clearance is the difference between the minimum cylinder bore diameter and the maximum outside diameter of the piston. As described in 4-3 Cylinder, piston clearance should be 0.040~0.045 mm. (0.0016~0.0018 in.)

To determine the maximum piston diameter, measure the piston with a micrometer at right angles to the skirt 10 mm. (3/8 in.) from its bottom edge. (Fig. 4-6-1)



Fig. 4-6-1

##### 2) Checking and correcting scratches on the piston

A piston showing signs of seizure will result in noise and loss of engine power. It will also cause damage to the cylinder wall.

If a piston that has seized is used again without correction, another seizure will develop in the same area. Lightly sand the seizure "high spot" on the piston with oil stone or #400 sandpaper until smooth. (Fig. 4-6-2)



Fig. 4-6-2

##### 3) Removing Carbon

Remove carbon accumulations on the piston head, using a screwdriver or a saw-blade. (Fig. 4-6-3)

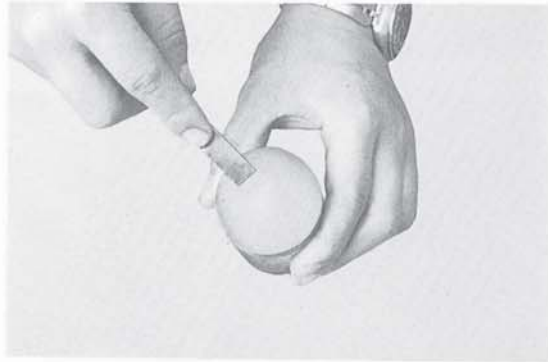

Fig. 4-6-3

Carbon and gum accumulations in the piston groove will result in piston ring seizure. Remove them from the ring groove. (Fig. 4-6-4)

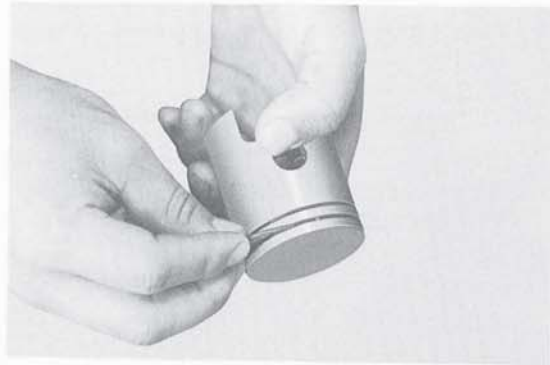

Fig. 4-6-4

**B. Piston Installation Direction**

Install the piston with the arrow mark on the head pointing forward (toward the exhaust port of the cylinder).

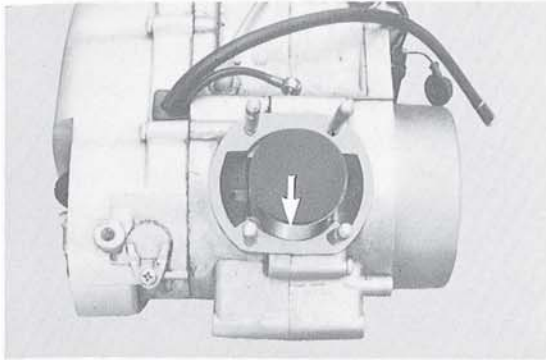

Fig. 4-6-5

**4-7. Flywheel Magneto**

A. Remove the nut using a flywheel magneto holding tool.

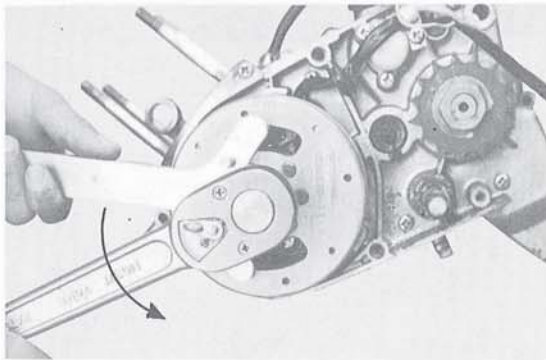

Fig. 4-7-1

B. Install the flywheel magneto puller. Turn it left and the flywheel magneto will break loose.

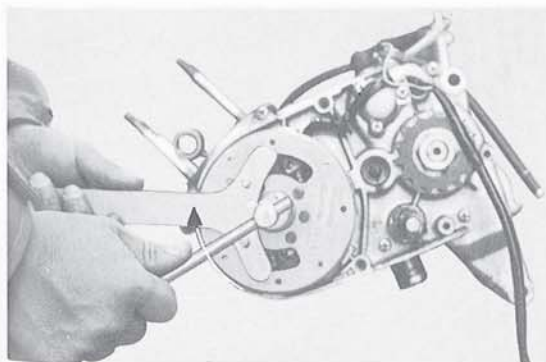

Fig. 4-7-2

C. Remove the three screws holding the flywheel magneto base to the crankcase, and remove the flywheel magneto base.

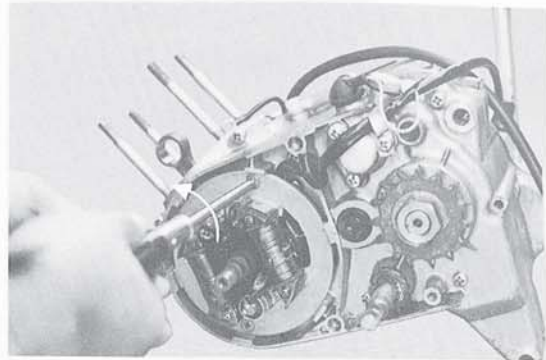

Fig. 4-7-3

D. Remove the woodruff key.

It is advisable to place the woodruff key on the flywheel magnets (using its magnetic force) while the key is removed for engine service.

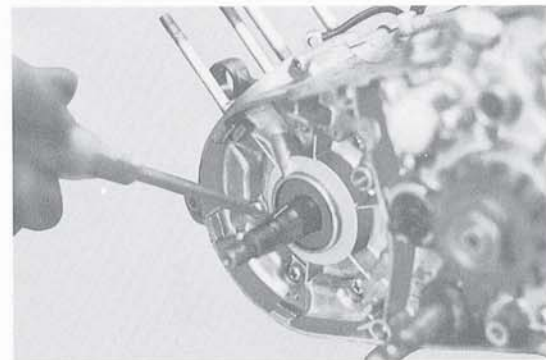

Fig. 4-7-4

#### 4-8. Crankcase Cover (R. H.)

##### A. Removal

- 1) Remove the kick crank mounting bolt and the crank.

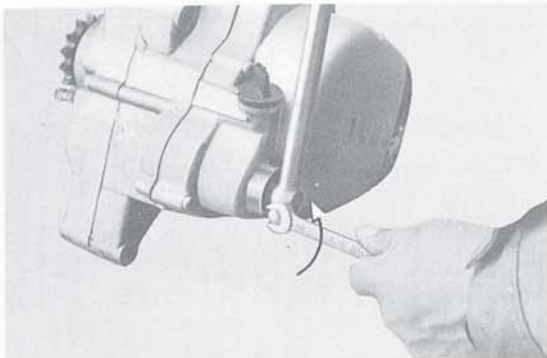

Fig. 4-8-1

- 2) Remove the pan head screws holding the crankcase cover, and then remove the case cover. (The cover can be removed without taking off the oil pump.)

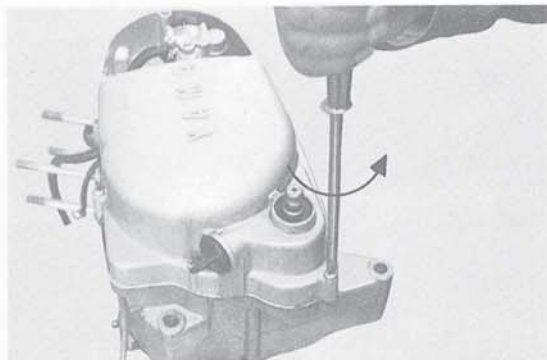

Fig. 4-8-2

- 3) Remove the crankcase cover gasket. Replace it, if damaged.

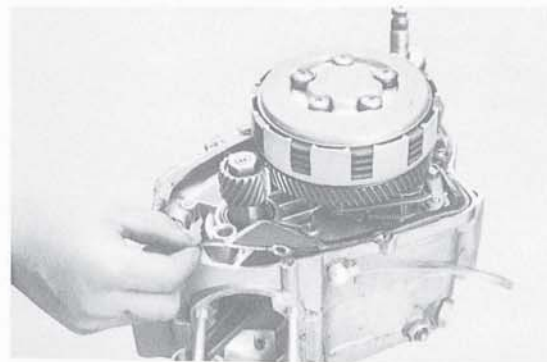

Fig. 4-8-3

##### B. Installation

Spread YAMAHA Bond No.5 over the mating surface of the crankcase R. Place the crankcase cover gasket on the crankcase and apply Yamaha Bond No.5 and replace the crankcase cover R. Be sure to apply YAMAHA Bond No.5 to the mating surface; otherwise, the crankcase will leak.

##### Note:

When installing the crankcase cover(R), make sure that the pump drive gear (made from synthetic resin) is correctly engaged with the primary drive gear.

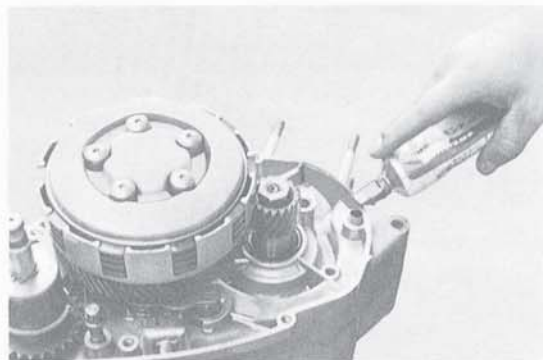

Fig. 4-8-4

#### 4-9. Clutch

The clutch is a wet, multi-disc type, consisting of four molded cork friction plates and five clutch plates in the clutch housing that is mounted on the transmission main axle. To disengage the clutch, an inner push rod system is employed. The primary driven gear, coupled with the clutch housing, is meshed with a kick pinion gear. This allows the

kick starter to be operated with the clutch disengaged or engaged.

A shock absorber consisting of rubbers is between the primary driven gear and the clutch housing.

The primary drive gear has 19 teeth, and the primary driven gear 74 teeth.

(Primary reduction ratio .....  $74/19=3.894$ )

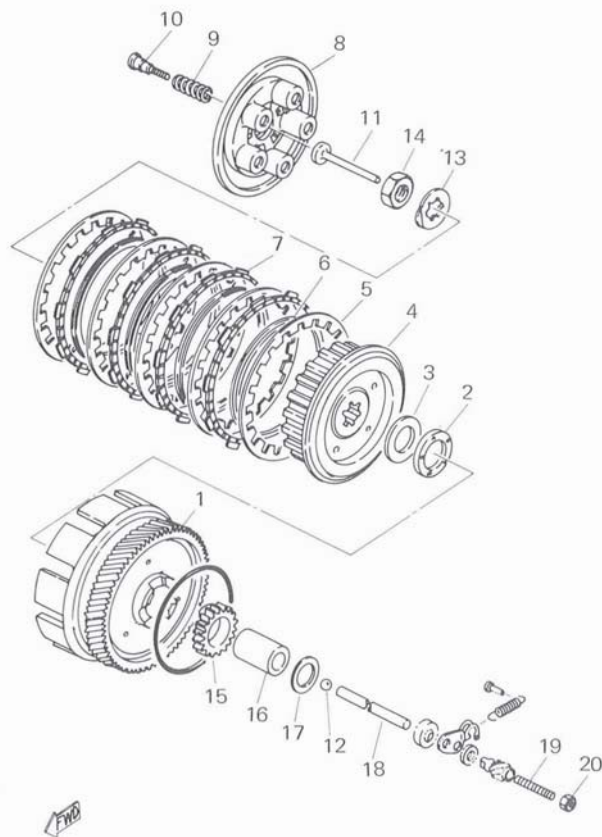

- |                        |                      |
|------------------------|----------------------|
| 1. Primary driven gear | 11. Push rod #1      |
| 2. Thrust bearing      | 12. Ball             |
| 3. Thrust plate        | 13. Lock washer      |
| 4. Clutch boss         | 14. Lock nut         |
| 5. Clutch plate        | 15. Kick pinion gear |
| 6. Cushion ring        | 16. Spacer           |
| 7. Friction plate      | 17. Thrust plate     |
| 8. Pressure plate      | 18. Push rod #2      |
| 9. Clutch spring       | 19. Adjusting screw  |
| 10. Spring screw       | 20. Nut              |

Fig. 4-9-1

## ENGINE - Clutch

### A. Removing the Pressure Plate

Remove the five clutch spring holding screws, and take out the pressure plate and push rod #1.

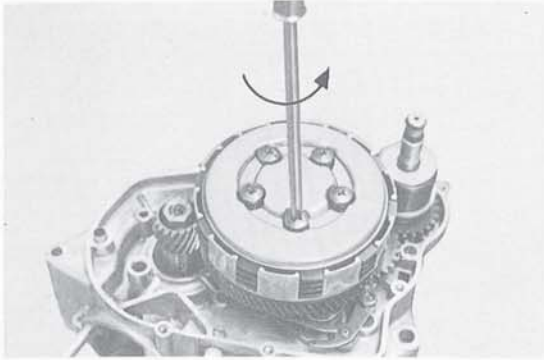

Fig. 4-9-2

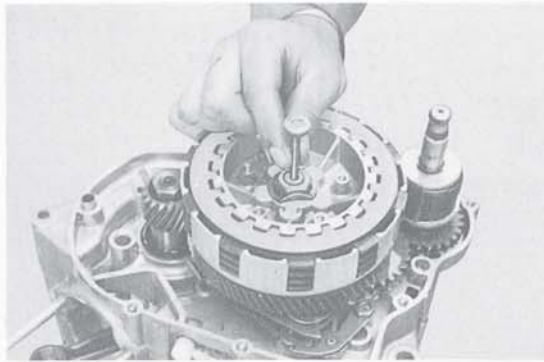

Fig. 4-9-3

### B. Removing the Clutch Boss

- 1) Straighten the lock washer with a chisel or a screwdriver.
- 2) Install the clutch holding tool on the clutch boss.
- 3) Loosen the lock nut, and then remove the clutch ass'y.

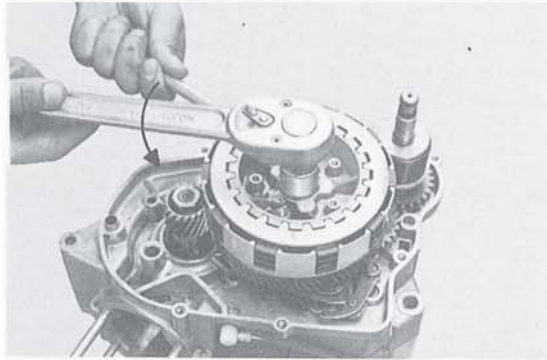

Fig. 4-9-4

### C. Checking the Clutch Spring

If the free length of the spring is 1 mm. (0.04 in.) or shorter than the standard free length, replace it.

Free length 34 mm (1.340 in.)

Fig. 4-9-5

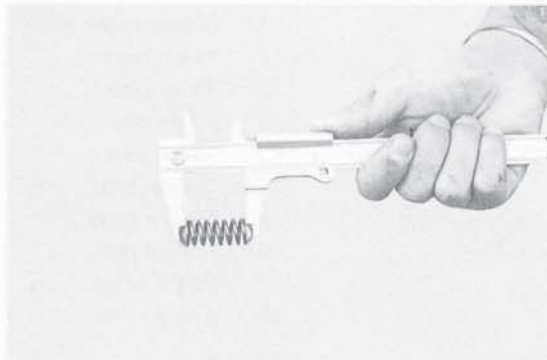

Fig. 4-9-6

**D. Checking the Friction Plates**

Inspect the friction plates for wear. Replace them if they show 4.0 mm. (0.157 in.) or more uneven contact.

Standard thickness 4.0 mm (0.157 in.)

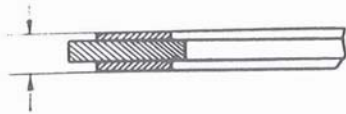

Fig. 4-9-7

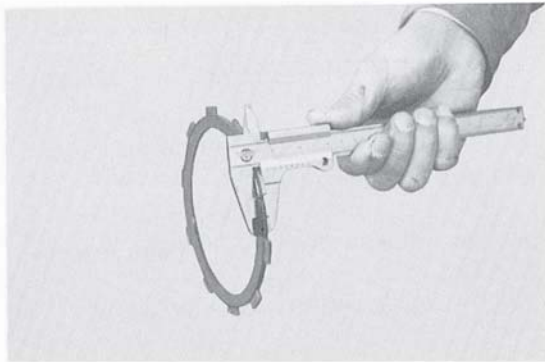

Fig. 4-9-8

**E. Clutch Housing Assembly (integrated with the primary driven gear).**

There is a rubber friction ring placed on the outside of the clutch between the primary driven gear and the clutch housing in order to reduce gear noise at low engine speeds.

**1) Inspection**

Insert the primary gear retaining collar (spacer) in the primary driven gear boss and check it for radial play. If the play is excessive (allowable clearance is between 0.009~0.048mm.), replace the gear retaining collar because it will cause excessive noise.

If any scratches are found, replace the spacer to avoid impaired clutch action.

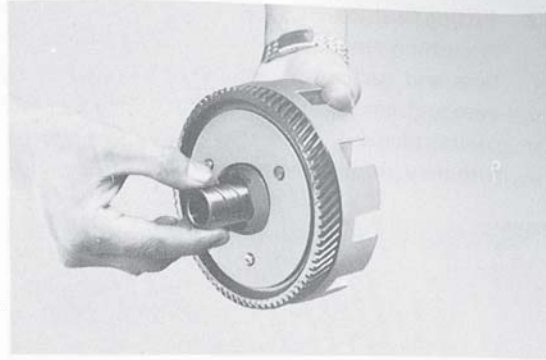

Fig. 4-9-9

**F. Checking the Primary Gear Retaining Collar (Spacer)**

Place the primary gear retaining collar around the main axle and again check it for radial play. If play exists (allowable clearance is between 0.020~0.062 mm.), replace the gear retaining collar.

Replace any collar with step-wear on its outer surface.

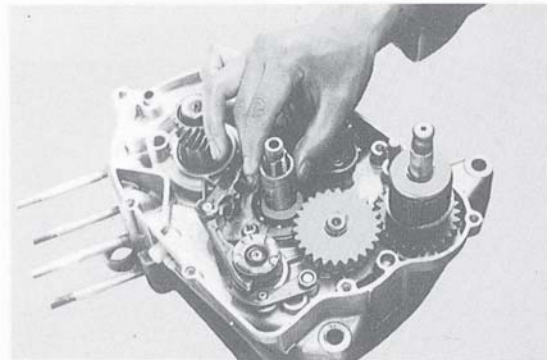

Fig. 4-9-10

**G. Fitting Cushion Rings**

A cushion ring is installed between the clutch boss and each of the friction plates to insure even engagement and complete disengagement of the plates. When fitting cushion rings, be sure they are flat and not twisted.

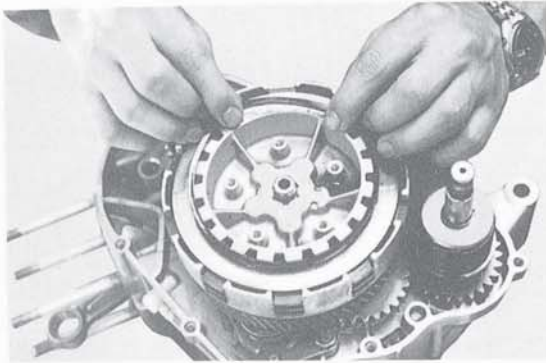

Fig. 4-9-11

**H. Checking the Push Rod**

Remove the push rod and roll it over a surface plate. If the rod is bent, straighten or replace it.

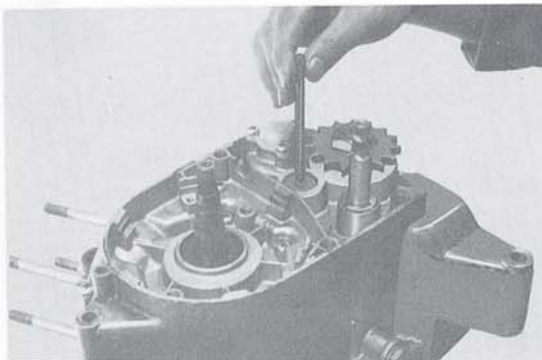

Fig. 4-9-12

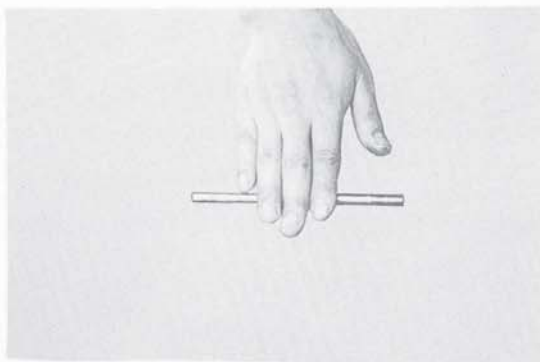

Fig. 4-9-13

**I. Caution on Re-assembling the Clutch**

- \* On both ends of the primary gear spacer are thrust washers and thrust bearings. If these washers and bearings are incorrectly installed, or omitted, the clutch boss will rub directly on the primary driven gear, impairing clutch action.
- \* The thrust bearing assembly fits on the primary retaining collar, but it may slip out of place when installing clutch boss. Therefore, apply grease to both surfaces of the bearing to make it stick to the gear retaining collar. Before installing the clutch plate, friction plate, etc., install the clutch boss on the main shaft.

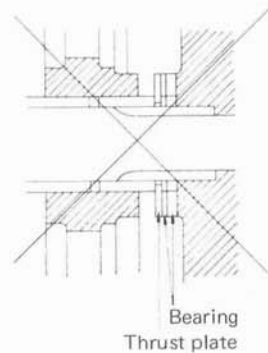
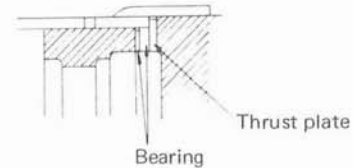
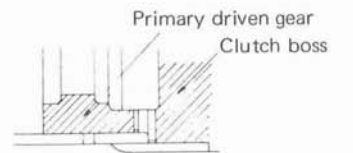

Fig. 4-9-14

## J. Adjusting the Clutch

### 1) Setting the Adjusting Screw

Turn the adjusting screw in until it lightly seats against the push rod. Next, back the screw off 1/4 turn to get the proper spacing, then tighten the lock nut.

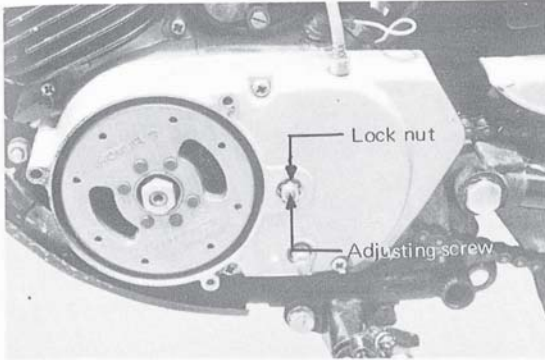

Fig. 4-9-15

### 2) Adjusting the Clutch Cable Tension

The clutch cable becomes slackened after being used for a long time. Occasionally the cable must be adjusted so that the play at the clutch handle is from 2 to 3 mm. (1/16~1/8 in.)

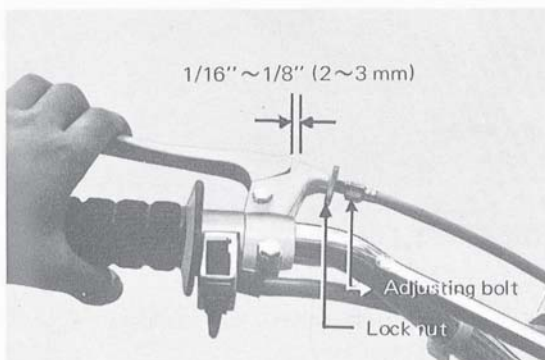

Fig. 4-9-16

## 4-10. Primary Drive Gear

### A. Removal

Feed a roll-up rag between the teeth of the primary drive gear and the primary driven gear to lock them, and loosen the primary drive gear lock nut.

The primary drive gear can then be forced off by grasping two fingers, as shown in Fig. 4-10-2.

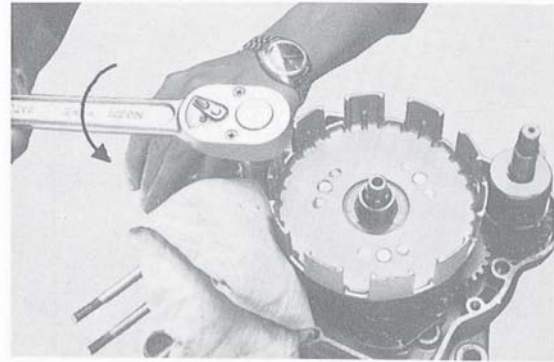

Fig. 4-10-1

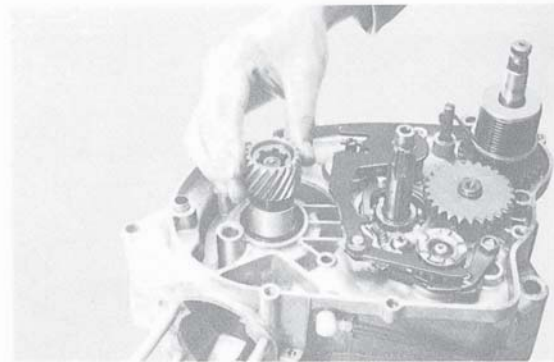

Fig. 4-10-2



4-11. Kick Starter Mechanism

The primary kick-starter system (one-touch kick-starter) is employed. However, a new "non-constant-mesh" mechanism has been introduced into the HT1-B kick-starter, instead of the constant-mesh kick gear type, such as the ratchet and roller-rock systems. That is, the kick gear meshes with idler gear only

when the kick starter pedal is kicked. After the engine has started, the kick gear and the idler gear disengage. This mechanism not only eliminates noise resulting from the constant mesh of the kick gear with the idler gear, but also greatly contributes to the durability of the kick starter assembly.

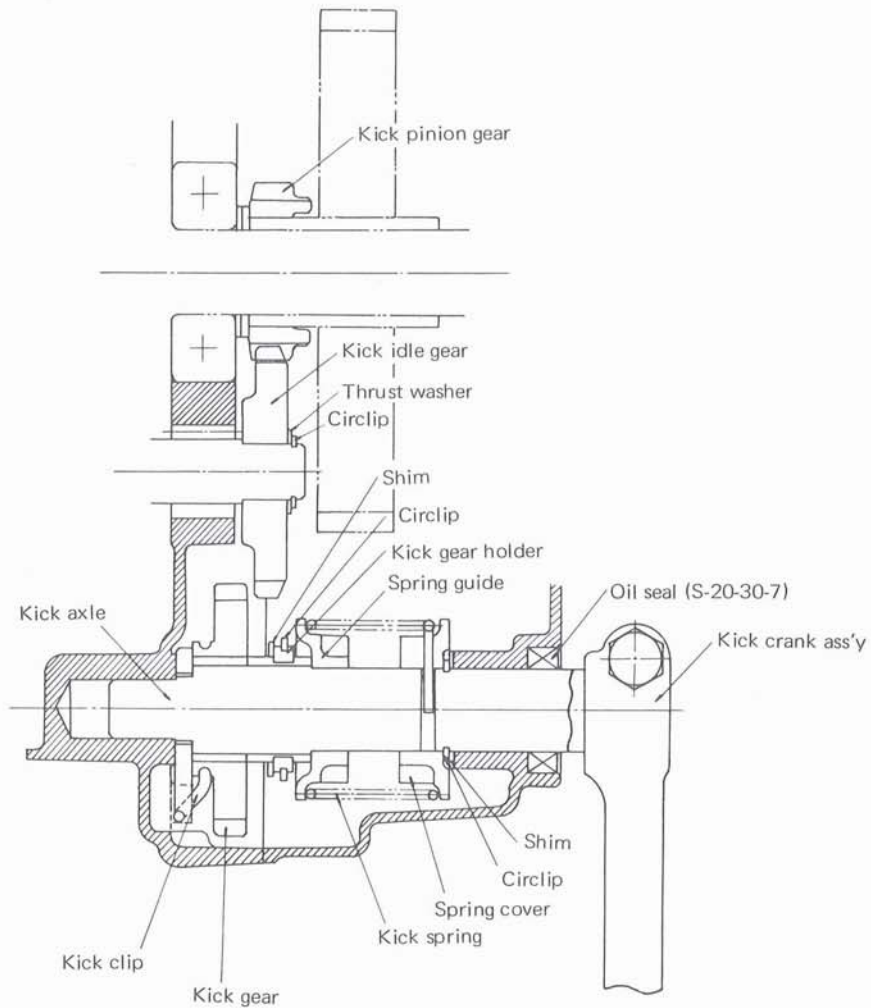
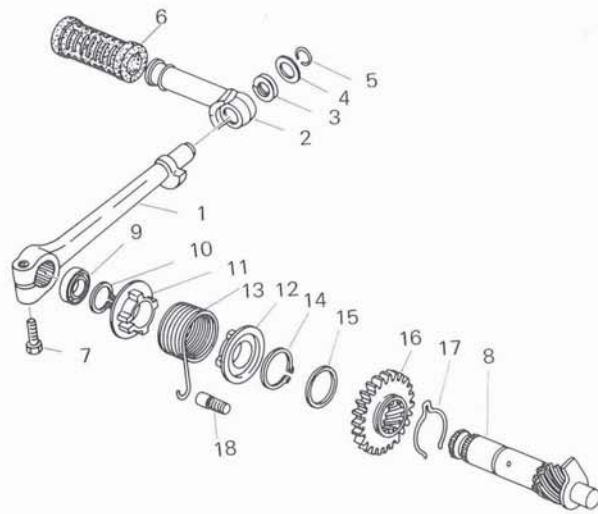

Fig. 4-11-1



1. Kick crank
2. Kick lever
3. Kick crank spring
4. Kick lever washer
5. Kick lever clip
6. Kick lever cover
7. Bolt
8. Kick axle ass'y
9. Oil seal
10. Circlip
11. Spring cover
12. Kick spring
13. Spring guide
14. Circlip
15. Shim
16. Kick gear
17. Kick clip
18. Kick spring stopper

Fig. 4-11-2

**A. Removal**

- 1) Remove the kick spring.

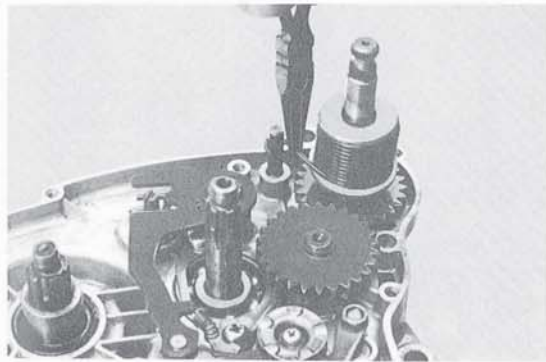

Fig. 4-11-3

- 2) Then remove the kick starter assembly.

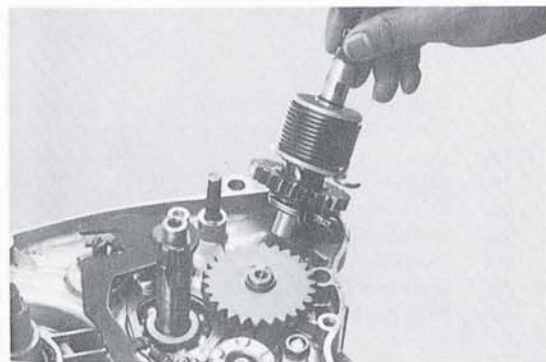

Fig. 4-11-4

**B. Removing the Kick Idler Gear**

Remove the circlip with clip pliers. Then the kick idler gear can be easily removed.

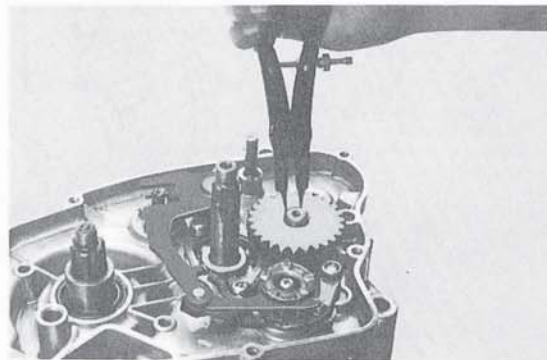
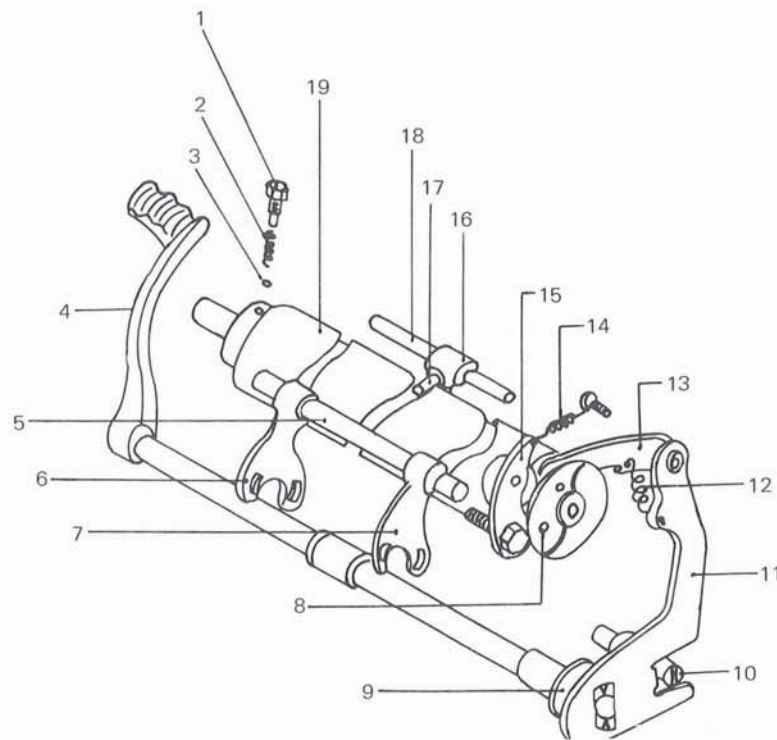

Fig. 4-11-5

4-12. Shift Mechanism

The HT1-B shift mechanism is operated in five stages by a see-saw type change pedal. As the change pedal is depressed, gear shift arm B moves gear shift arm A, which in turn pushes on one of the gear shift pins attached to the gear shift drum, thereby turning the gear shift drum. A total of five gear shift pins are attached to the drum, and therefore, each time the change pedal is depressed, the drum rotates 1/5 of a revolution. That is, one full turn of the gear shift drum is made in five stages; 1st, 2nd, 3rd, 4th and 5th.

Slotted guides are grooved in the shift drum, and the shift fork cam follower pins are placed in these slotted guides. Therefore, as the drum turns, the shift forks slide back and forth in the slotted guides. Shift fork (1) moves the 2nd and 3rd gears, shift fork(2) the 1st gear, and shift fork(3) moves the 4th and 5th gears. The neutral position is located between 1st and 2nd gears, and the neutral stopper mechanism is located on the left side of the shift drum.



- |                             |                               |
|-----------------------------|-------------------------------|
| 1. Neutral spring screw     | 11. Gear shift arm B          |
| 2. Spring                   | 12. Gear shift arm spring     |
| 3. Ball                     | 13. Gear shift arm A          |
| 4. Change pedal             | 14. Shift drum stopper spring |
| 5. Shift fork guide bar     | 15. Shift drum stopper lever  |
| 6. Shift fork (1)           | 16. Shift fork (2)            |
| 7. Shift fork (3)           | 17. Cam follower pin          |
| 8. Gear shift drum pin      | 18. Shift fork guide bar      |
| 9. Gear shift return spring | 19. Shift drum                |
| 10. Adjusting screw         |                               |

Fig. 4-12-1

**A. Removing the Change Shaft Assembly**

- 1) Remove the circlip and washer from the change axle (left side crank case).

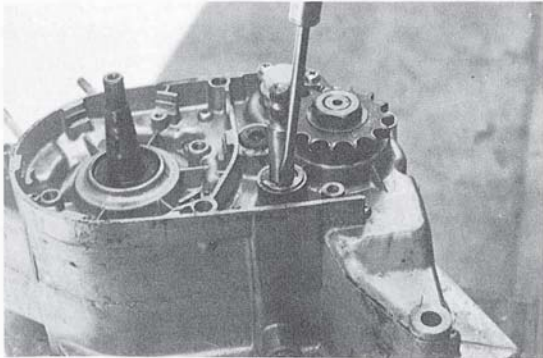

Fig. 4-12-2

- 2) Turn the engine over, right side up, and pull out the change shaft assembly.

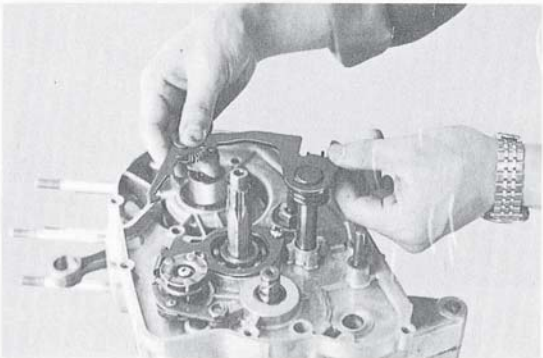

Fig. 4-12-3

**B. Checking the gear shift parts (Fig. 4-12-4)**

Check the Gear Shift Return Spring. A broken or fatigued gear shift return spring will impair the return action of the shifting mechanism.

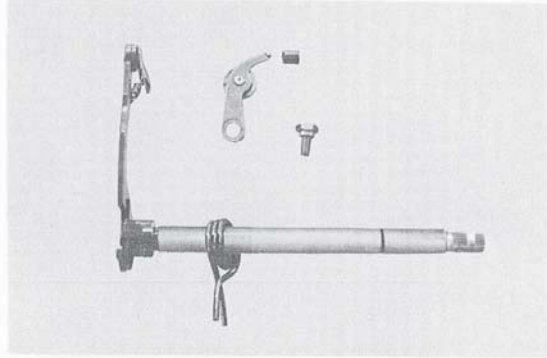

Fig. 4-12-4

**C. Adjusting the gear shift arm**

Adjusting or correcting the travel of the gear shift arm to prevent improper shifting progression (excess feed or insufficient feed of the gear shift arm) is accomplished by turning the gear shift return spring stop screw (eccentric bolt) in or out. (Fig. 4-12-5)

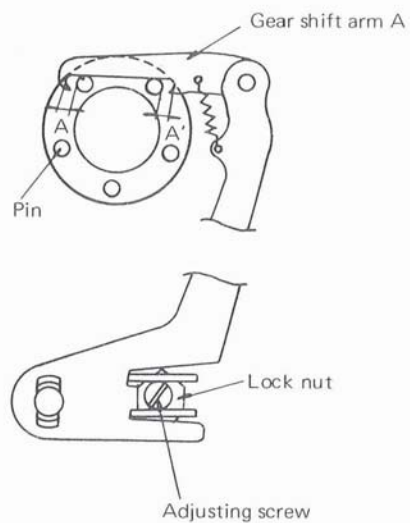

Fig. 4-12-5

### 4-13. Drive Sprocket

#### A. Removal

- 1) Straighten the bent edge of the lock washer with a blunt-ended metal punch.

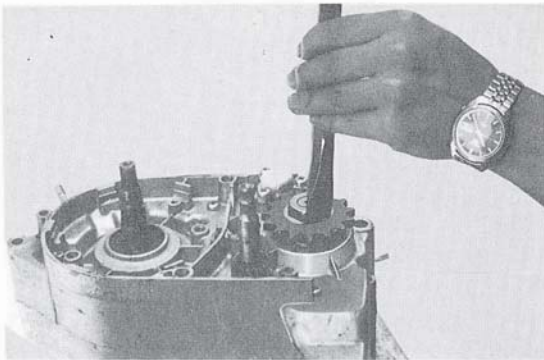

Fig. 4-13-1

- 2) Hold the drive sprocket with the flywheel magneto holding tool, and remove the sprocket nut. If the flywheel magneto holding tool is not available, shift the transmission to low gear, and fit a monkey wrench on the sprocket nut. Then tap the handle of the wrench with a hammer and the shock will loosen the nut.

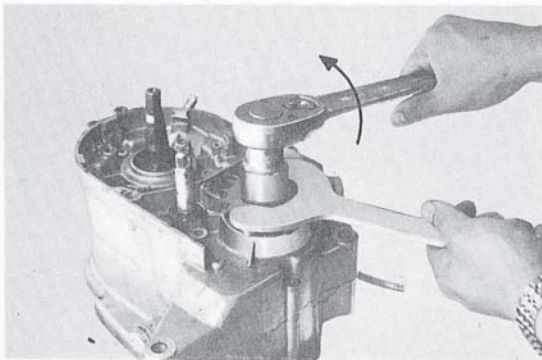

Fig. 4-13-2

#### B. Inspection

A worm drive sprocket will result in excessive chain noise and shorten the life of the chain. Check the sprocket for worn teeth, and replace if they are worn.

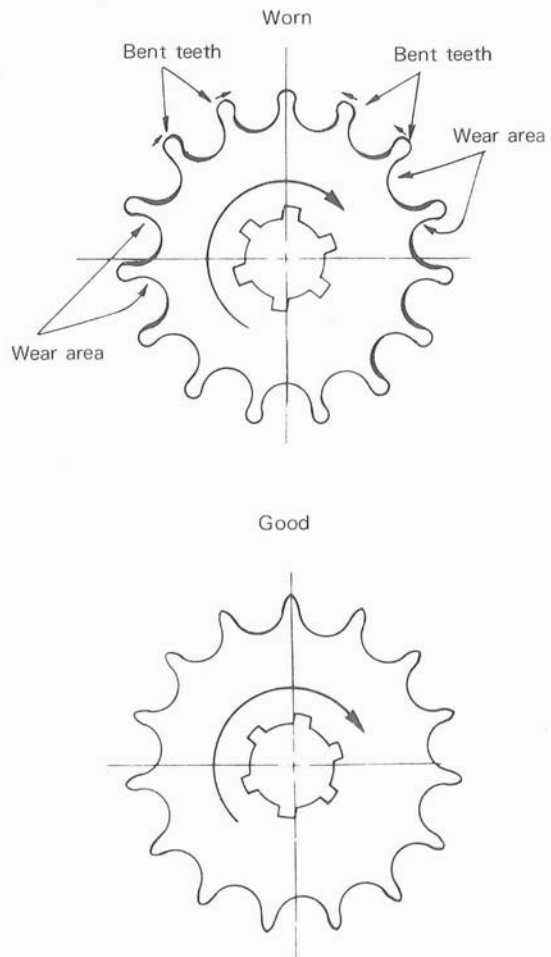

Fig. 4-13-3

4-14. Crankcase

A. Separating

- 1) Remove neutral stopper.

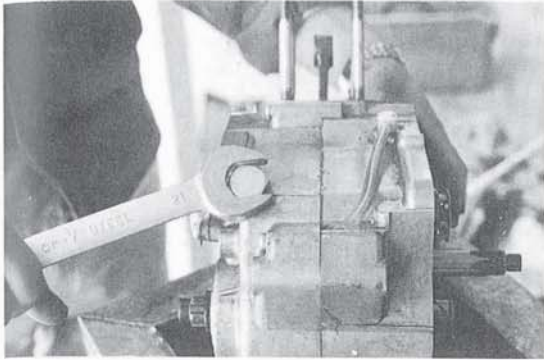

Fig. 4-14-1

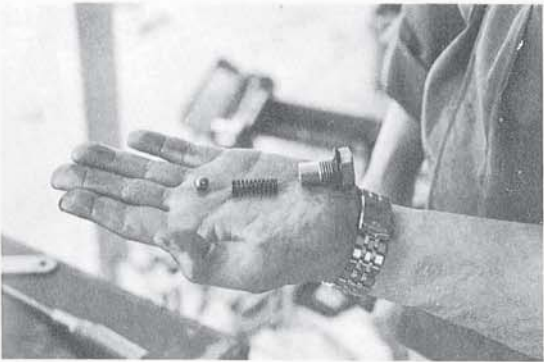

Fig. 4-14-2

- 2) Remove the change shift drum stopper lever and stopper spring.

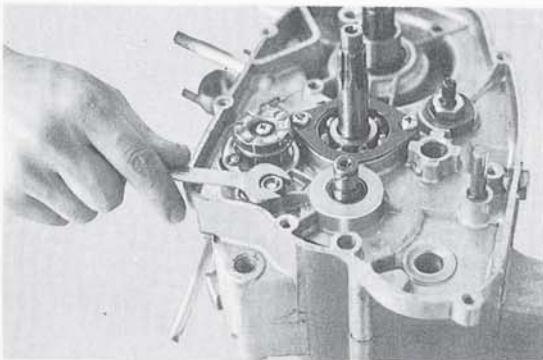

Fig. 4-14-3

- 3) Remove the pan head screws from the left crankcase.

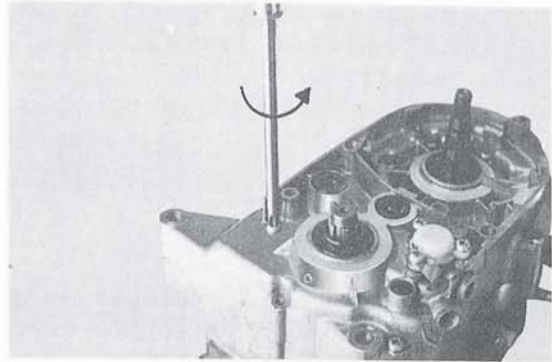

Fig. 4-14-4

- 4) Install the crankcase separating tool on the right crankcase. Divide the crankcase while alternately tapping the main axle and the crankcase with a rubber tipped hammer (4-14-5, 4-14-6).

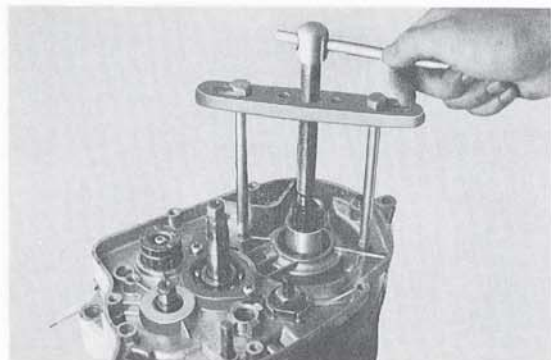

Fig. 4-14-5

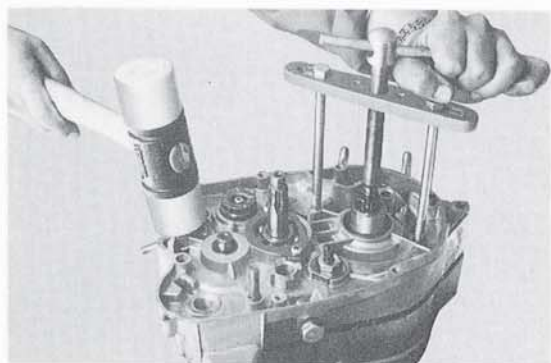

Fig. 4-14-6

## ENGINE - Crankcase

---

### Note:

Fully tighten the bolts of the crankcase dividing tool, keeping the tool in a horizontal position.

The crankcase is designed to split into two halves, right and left. Only one drain plug is provided for both the transmission and clutch housings. Both housings can be drained at the same time by removing the drain plug.

### B. Reassembling

When reassembling the crankcase, be sure to apply YAMAHA BOND No.4 to the mating surfaces of both halves after cleaning them thoroughly.

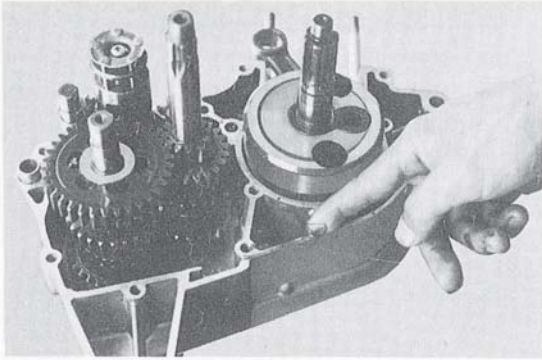

Fig. 4-14-7

4-15. Transmission Assembly

The constant mesh, wide ratio, 5-speed transmission makes it possible to fully utilize the steady performance of the engine throughout the entire speed range from low to high.  
For layout of the transmission and related parts,

refer to Fig. 4-15-1 and 2. The primary reduction ratio is  $74/19=3.894$ . Therefore the total reduction ratios will be; Primary reduction ratio  $\times$  Transmission gear reduction  $\times$  Secondary reduction ratio = Total reduction ratio.

Primary Reduction Ratio.....		$74/19 = 3.895$
Secondary Reduction Ratio.....		$49/14 = 3.500$
	Transmission Gear Reduction Ratio	Total Reduction Ratio
1st	$35/11 = 3.182$	43.373
2nd	$30/15 = 2.000$	27.263
3rd	$26/19 = 1.368$	18.653
4th	$23/23 = 1.000$	13.631
5th	$20/25 = 0.800$	10.905

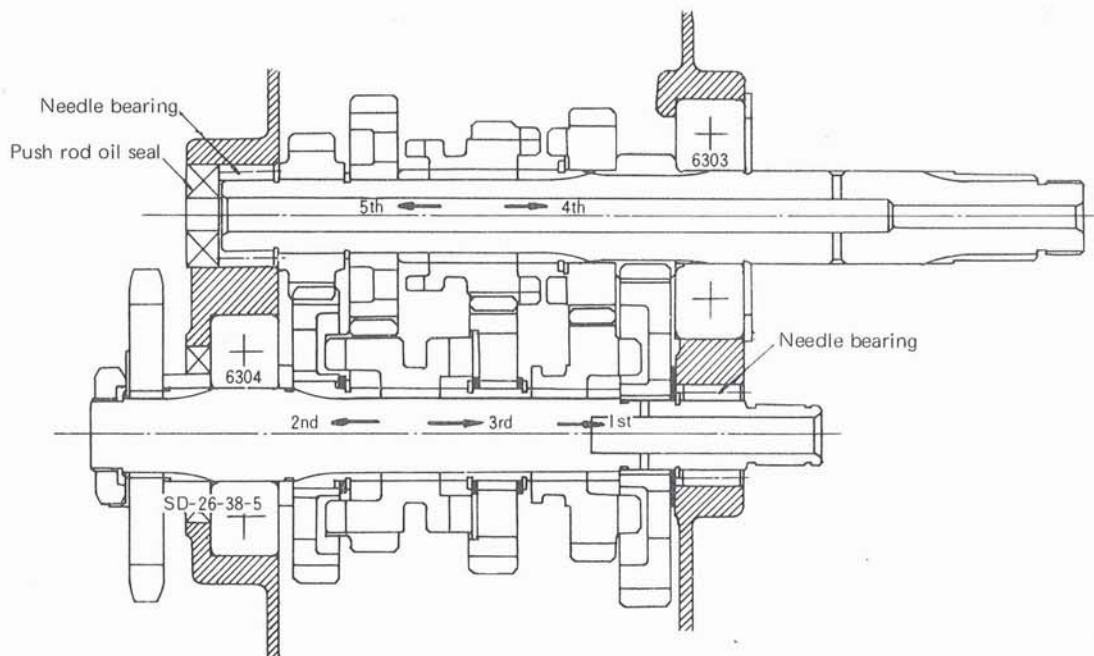

Fig. 4-15-1



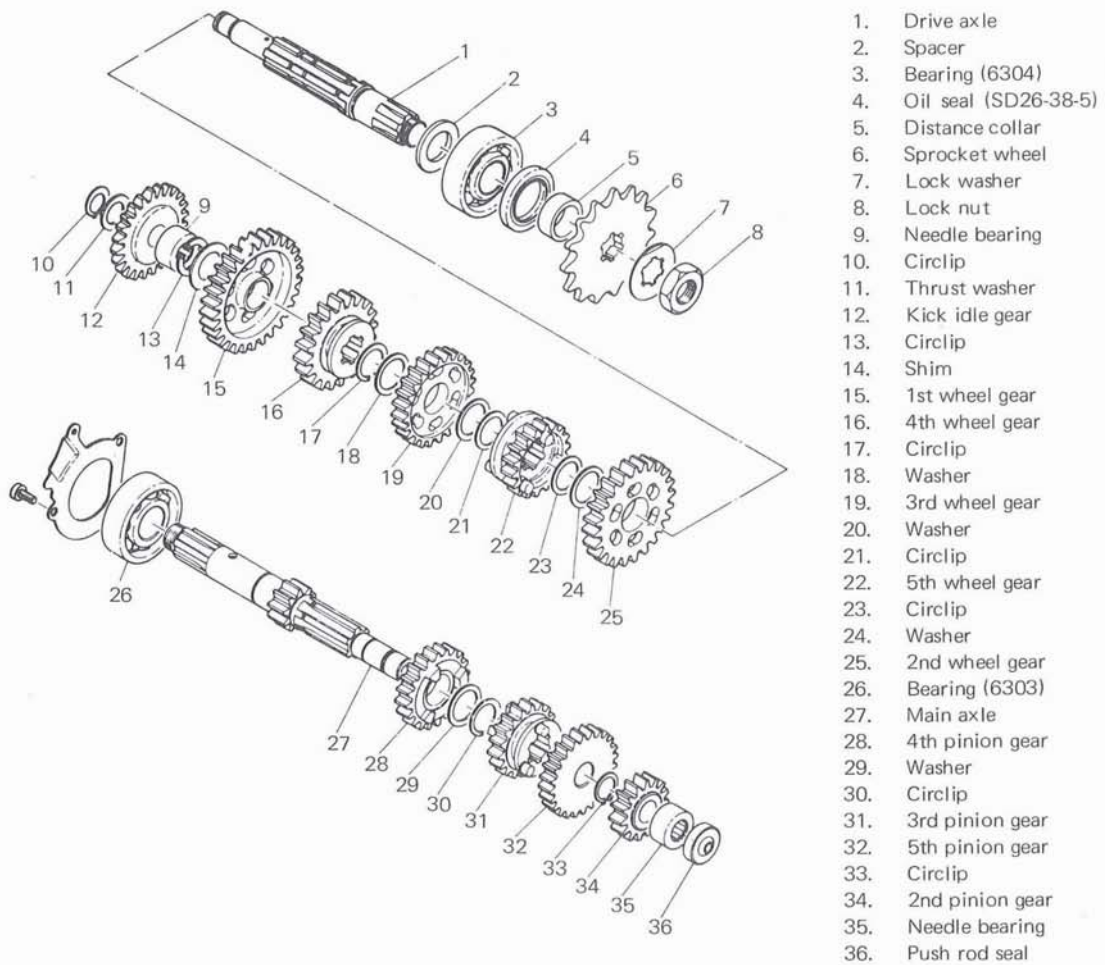

Fig. 4-15-2

A. Removal

1) Pull out the two shift fork guide bars.

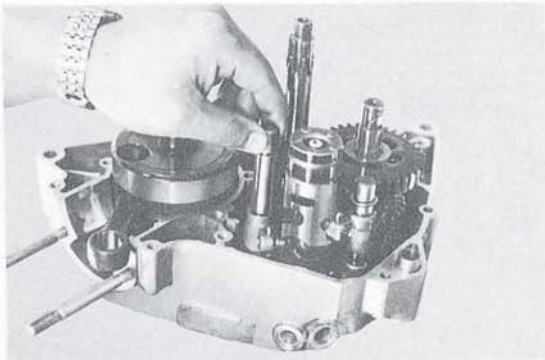

Fig. 4-15-3

2) Remove both the transmission assembly and the shift forks from the crankcase, while tapping the drive shaft end with a plastic-tip hammer. (Fig. 4-15-4)

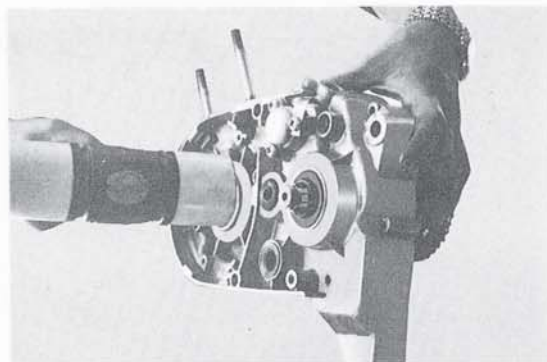

Fig. 4-15-4

- 3) To remove the shift drum, remove the shift cam blind plug set screw on the left side of the crankcase, and remove the shift cam blind plug. Then remove the circlip and shift cam guide from the shift drum, and the shift drum can be pulled out from the opposite side.

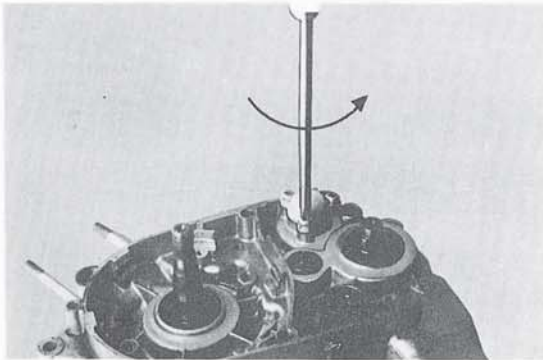

Fig. 4-15-6

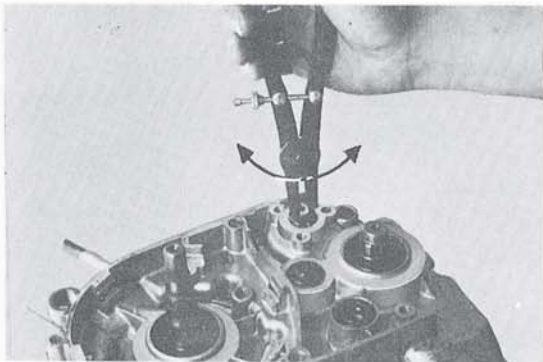

Fig. 4-15-7

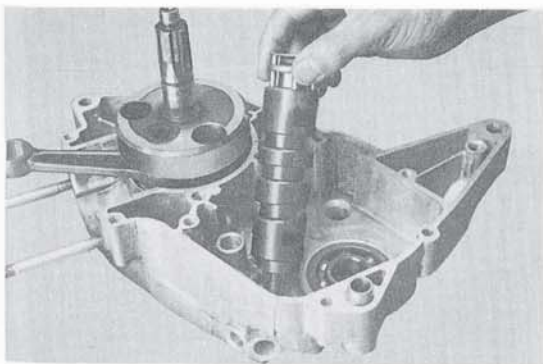

Fig. 4-15-8

**B. Reinstallation**

Reinstall the transmission and shifter as a unit in the left crankcase half after they are sub-assembled. They cannot be installed separately. The transmission unit must be in neutral during installation.

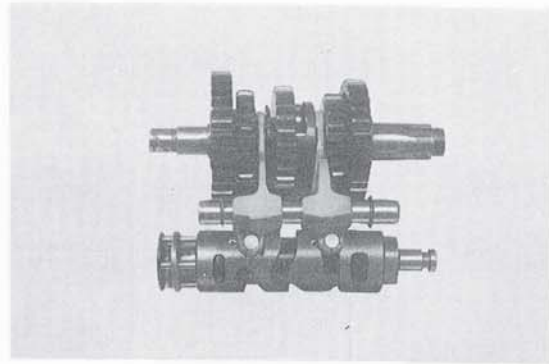

Fig. 4-15-9

4-16. Crankshaft

The crankshaft requires the highest degree of accuracy in engineering and servicing of all the engine parts.

The crankshaft is also more susceptible to wear, and therefore, it must be handled with special care.

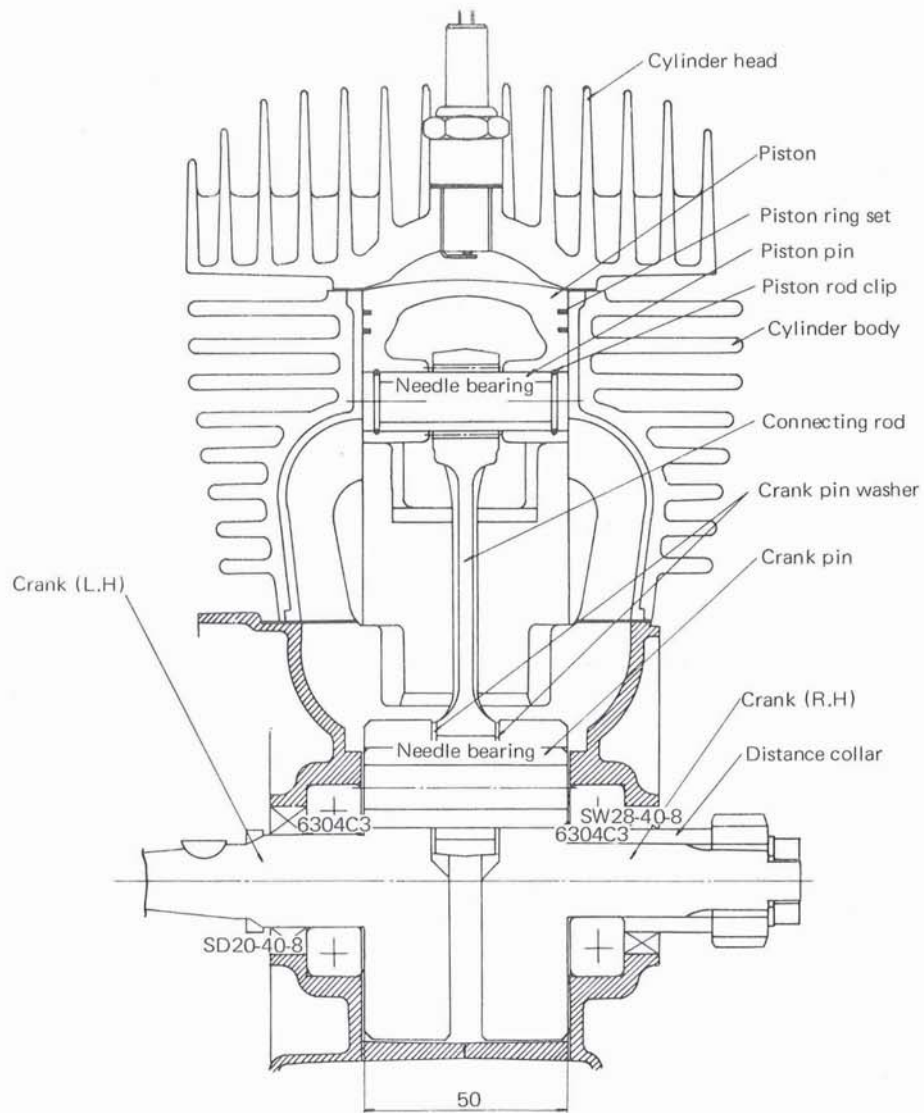

Fig. 4-16-1

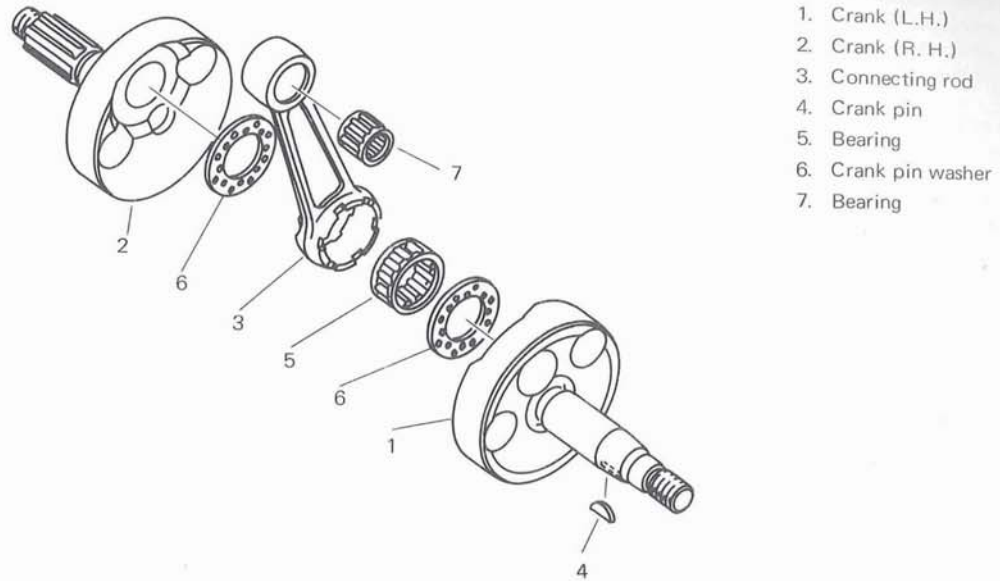

Fig. 4-16-2

**A. Removing the Crankshaft Assembly**

Remove the crankshaft assembly with the crankcase separating tool.

**Note:**

Fully tighten the bolts of the crankcase dividing tool, and keep the tool parallel with the crankcase surface.

**B. Installing the Crankshaft Assembly**

Install the crankshaft assembly by using the crankshaft setting tool and the crank fitting spacer.

Hold the connecting rod at top dead center with one hand while turning the handle of the setting tool with the other.

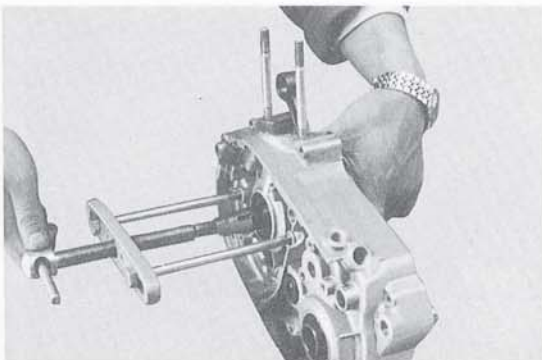

Fig. 4-16-3



Fig. 4-16-4

## ENGINE - Crankshaft

### C. Inspection and Servicing

#### 1) Checking the crankshaft components

Check connecting rod axial play at small end (to determine the amount of wear of crank pin and bearing at large end) Fig. 4-16-5)	Small end play should not exceed 2 mm. (0.078 in.)	If small end play exceeds 2 mm, disassemble the crank shaft, check connecting rod crank pin and large end bearing. Replace defective parts. Small end play after reassembly should be within 0.8 – 1.0 mm (0.031 – 0.04 in.)
Check the connecting rod for axial play at large end. (Fig. 4-16-6)	Move the connecting rod to one side and insert a feeler gauge. Large end axial play should be within 0.4 – 0.5 mm. (0.019 in.)	If excessive axial play is present, (0.6 mm or more) disassemble the crankshaft and replace any worn parts.
Check accuracy of the crankshaft ass'y runout. (Misalignment of parts of the crankshaft) (Fig. 4-16-7)	Dial gauge readings should be within 0.03 mm. (0.0012 in.)	Correct any misalignment by tapping the flywheel with a brass hammer and by using a wedge.

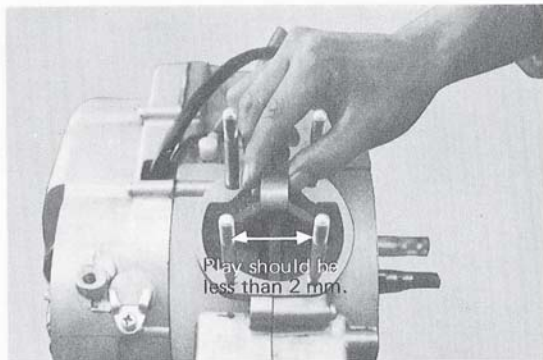

Fig. 4-16-5

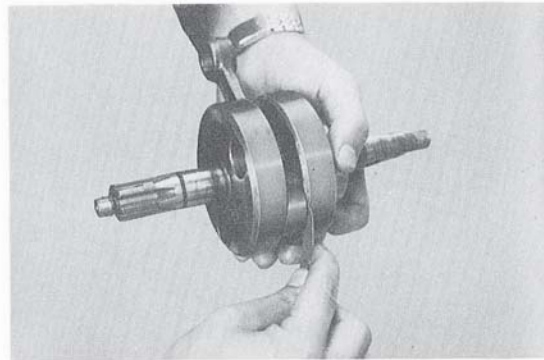

Fig. 4-16-6

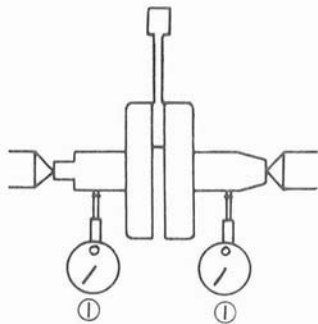

Fig. 4-16-7

## 4-17. Bearings and Oil Seals

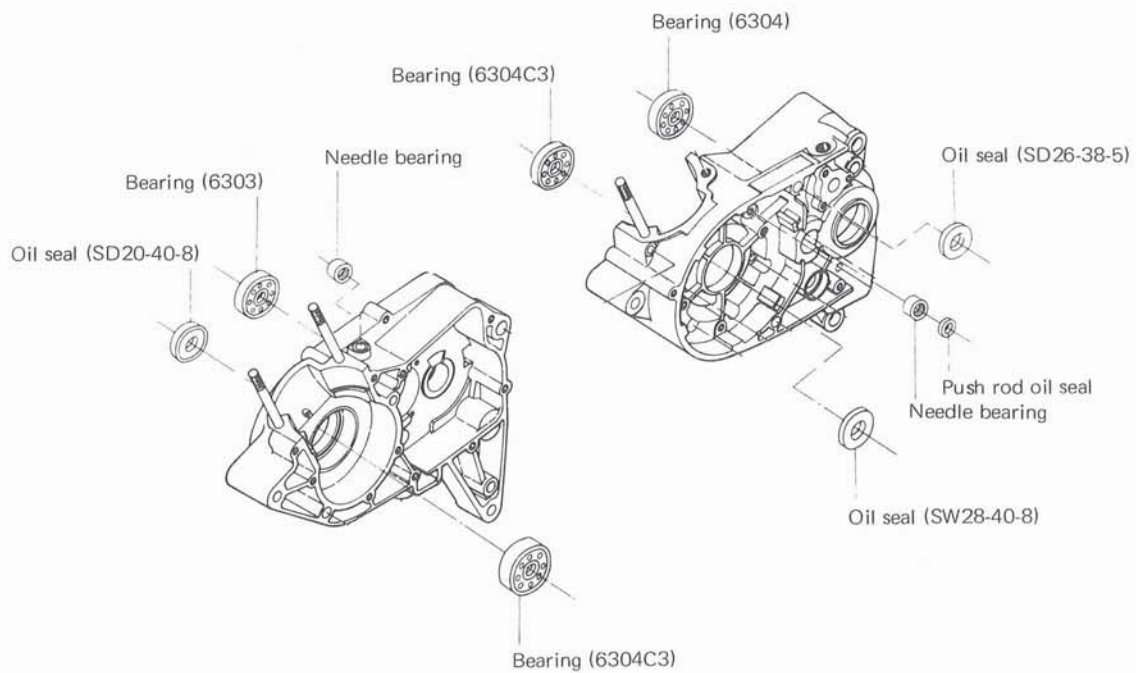

Fig. 4-17-1

## 1. Removal and Installation

## 1) Removal

- a. Pry the oil seals out of place with a slot head screwdriver. Always replace the oil seals when overhauling the engine.

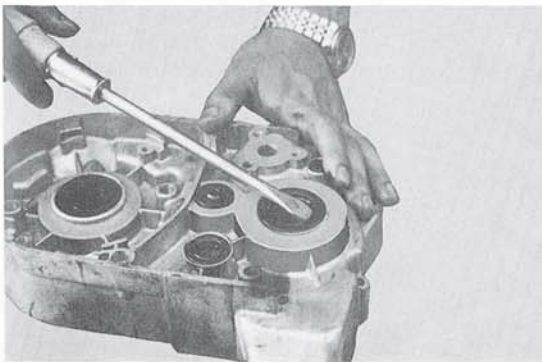

Fig. 4-17-2

- b. Drive out the bearing with a bearing tool.

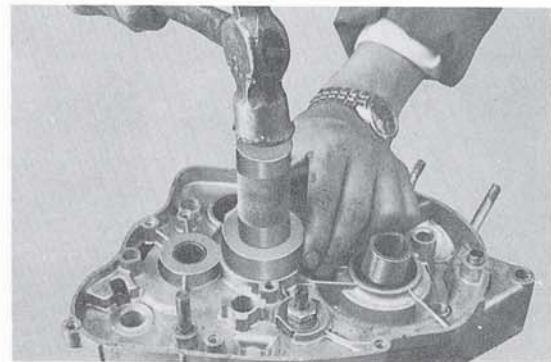

Fig. 4-17-3

## 2) Installation

Install bearings and oil seals with their stamped manufacturer's marks or numerals facing outward. (In other words, the stamped letters must be on the exposed view side.)

When installing bearings, pack them with grease.

4-18. Carburetor

The standard HT1-B is equipped with a VM20SC carburetor that is equipped with a built-in starter jet.

The carburetor floats have been specially designed to keep the float level from fluctuating due to

vibration or shock. The main jet is installed in such a manner to provide quick and easy replacement from the outside by merely removing the jet holder on the bottom left side of the carburetor float bowl.

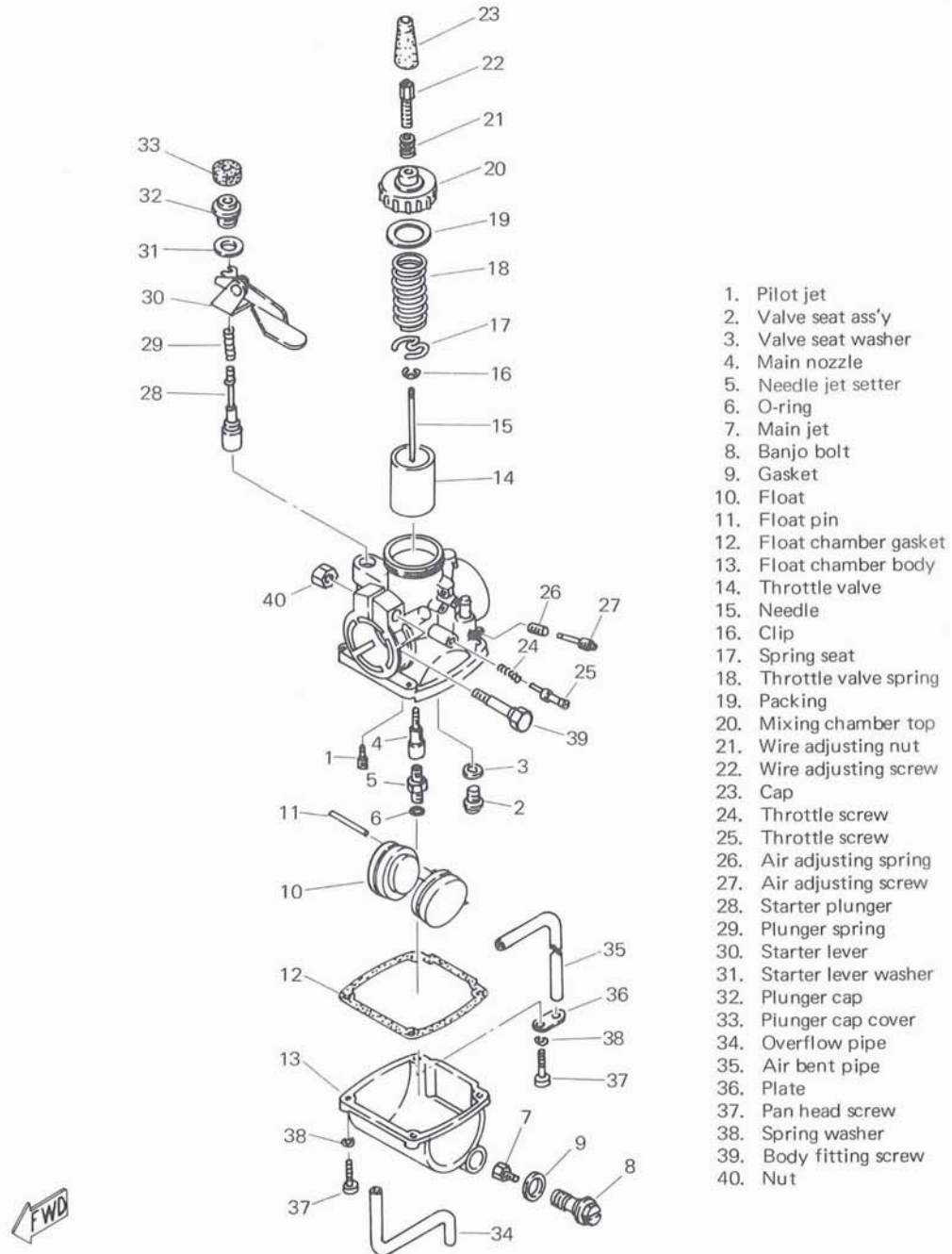

Fig. 4-18-1

**A. Checking the Carburetor**

## 1) Float

Remove the float and shake it to check if gasoline is inside. If fuel leaks into the float while the engine is running, the float chamber fuel level will rise and make the fuel mixture too rich. Replace the float if it is deformed or leaking.

## 2) Float valve

Replace the float valve if its seating end is worn with a step or if it is scratched. Check the float valve spring for fatigue. Depress the float valve with your finger, and make sure that it properly seats against the valve seat. If the float valve spring is weakened, fuel will overflow, flooding the float chamber while the gas is on.

## 3) Overflowing

If fuel overflows, check the carburetor as described in 1) and 2) above. If neither 1) nor 2) cures the overflowing, it may be caused by dirt or dust in the fuel preventing the float valve from seating properly. If any dirt or dust is found, clean the carburetor, petcock and gas tank.

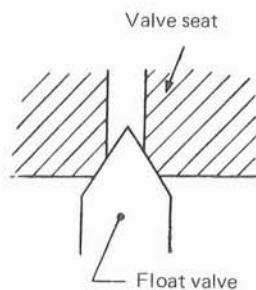

Fig. 4-18-2

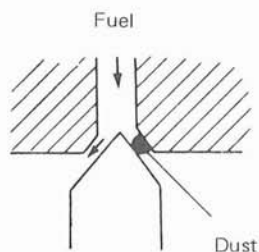

Fig. 4-18-3

## 4) Cleaning the carburetor

Disassemble the carburetor, and wash all its parts in a suitable solvent.

Then blow all the parts off with compressed air. All jets and other delicate parts should be cleaned by blowing compressed air through them after the float bowl has been removed.

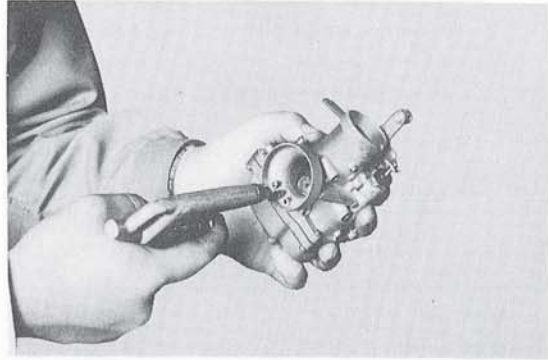

Fig. 4-18-4

**B. Float Level Adjustment**

The carburetor float level is checked by the Yamaha factory during assembly and testing. But rough riding, worn needle valve, or bent float arm can cause the float level to fluctuate. If the float level raises, this will cause a rich fuel/air mixture that can cause poor performance and spark plug fouling. If the float level decreases, this can cause a lean fuel/air mixture that can result in engine damage. If the machine is subjected to continuous rough riding or many miles of travel, the float level should be checked and set regularly and in the following manner.

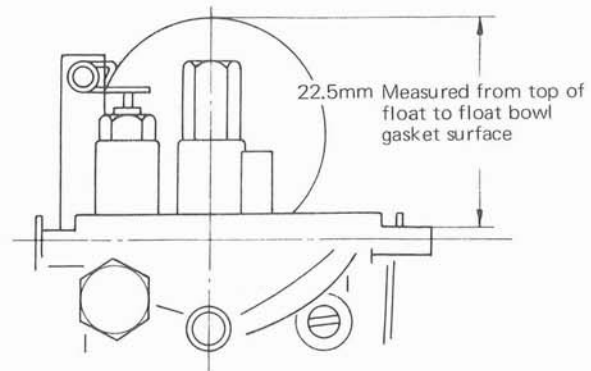

Fig. 4-18-5



## ENGINE - Air Cleaner

- 1) Remove the float chamber body, and turn over the mixing body. Let the float arm rest on the needle valve without compressing the spring.
- 2) Then measure the distance from the top of the float to the float bowl gasket surface.  
Standard measurement 22.5 mm
- 3) When the distance measures less than the recommended distance, bend the tang up. If it is greater, bend the tang down. (with carburetor body upside down.)

### C. Idle Mixture-Idle Speed Adjustments

The idle Mixture adjustment should be set exactly to factory specifications. First, turn the air screw in until it lightly seats then back it out 1-3/4 turns. Next, adjust the throttle stop so that the engine idles at 1350~1450 rpm.

### D. Carburetor Setting Table

Name of Parts	Abbreviation	Specification
		HT1
Main jet	M. J	#85
Needle jet	N. J	N-6
Jet needle	J. N	4D3-3 stages
Pilot jet	P. J	#30
Starter jet	G. S	#40
Throttle valve cut away	C. A	2.0
Air screw setting	A. S	1 3/4
Idling speed	—	1350~1450 rpm
Ident. Mark	—	277E1

## 4-19. Air Cleaner

### A. Removal

To remove the air cleaner ass'y, first remove the frame fitting bolt and loosen the screw of the cleaner band. Then the cleaner ass'y can be removed. Next, remove the air cleaner cap fitting bolt, element can pull out from case.

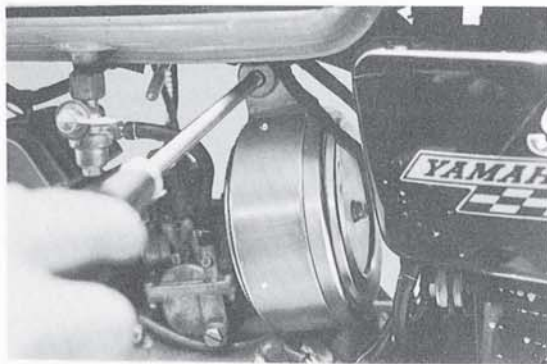

Fig. 4-19-1

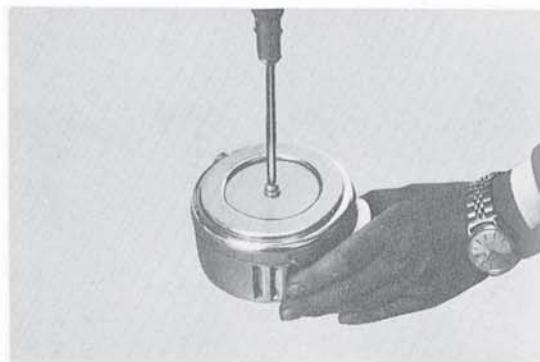

Fig. 4-19-2

**B. Cleaning**

Wash the foam filter thoroughly in solvent until all dirt has been removed. Squeeze all the solvent out. Pour oil onto the filter (any grade of 20 or 30 wt), work it completely in, and then squeeze out the surplus oil. The filter should be completely impregnated with oil, but not "dripping" with it.

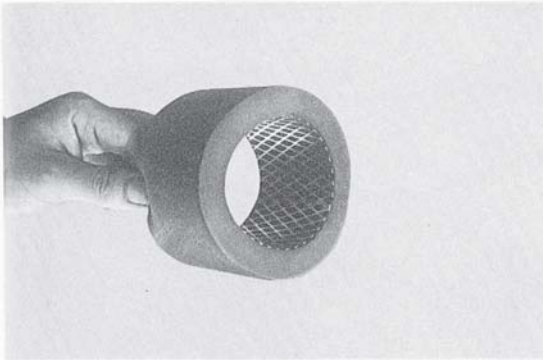

Fig. 4-19-3

## CHAPTER 5. CHASSIS

The Yamaha HT1-B has been designed for versatility and a combination of uses. It is equipped with all necessary street legal equipment to insure pleasurable road or street riding. This machine can be quickly converted to a competition machine and therefore has been engineered to have a minimum weight factor. Yet with the reduction in weight; rigidity, strength, and safety have been incorporated in the design of the frame to provide an unexcelled competition machine.

## 5-1. Front Wheel

The 18" front wheel is equipped standard with a 2.75-18" Trials Universal tire.

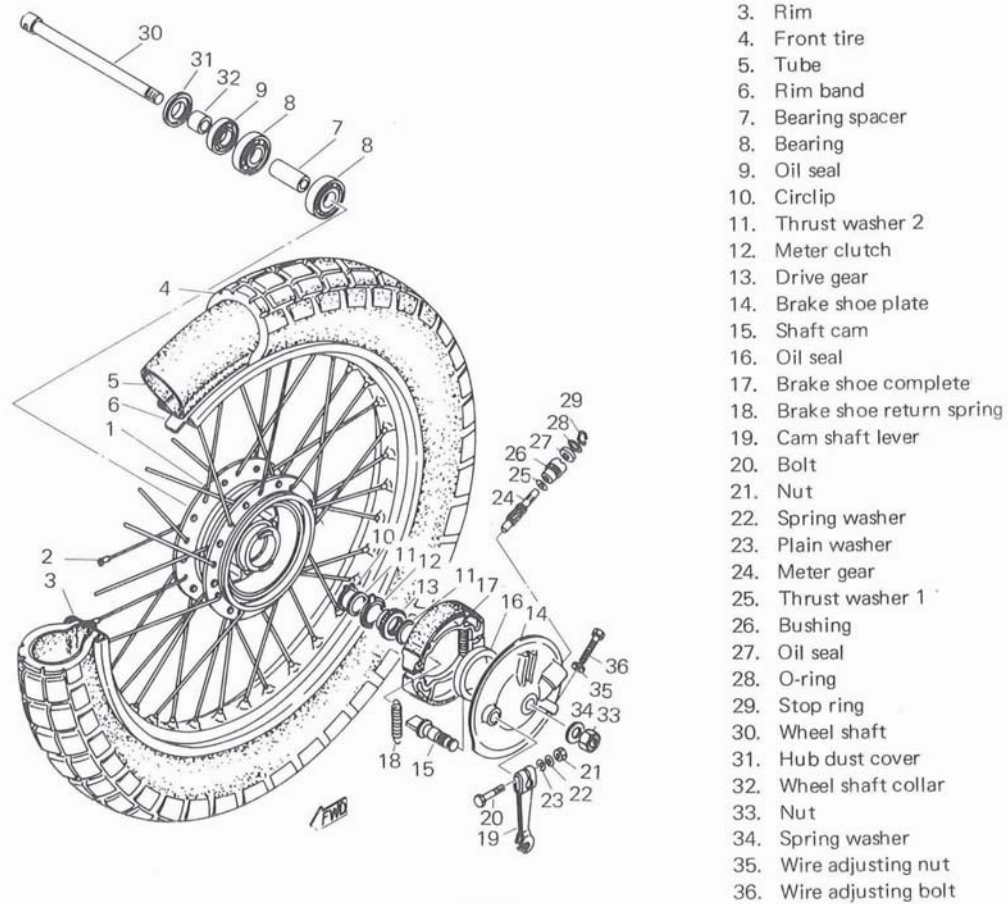

Fig. 5-1-1

This tire gives the rider assurance of maximum performance and safety for both road riding and trail riding. The front wheel brake size is 110 mm. x 25 mm. (4.33 x 0.98 in.) A labyrinth seal is installed between the wheel hub and brake plate to provide a seal against dust and water.

**A. Removal**

- 1) Disconnect the brake cable at the front brake lever.

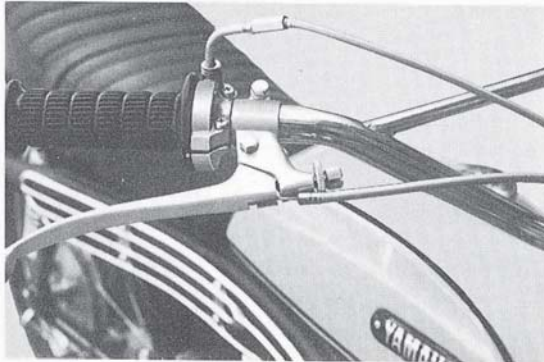

Fig. 5-1-2

- 2) Disconnect both the brake cable and speedometer cable from the front brake shoe plate.

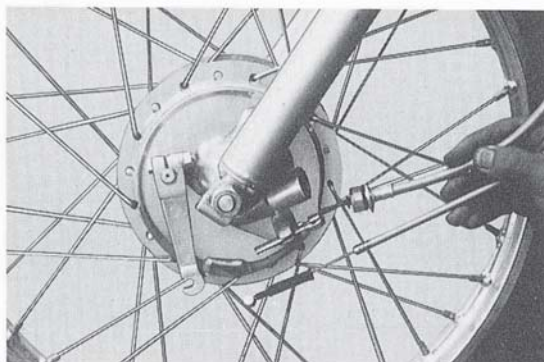

Fig. 5-1-3

- 3) Remove the front wheel nut.

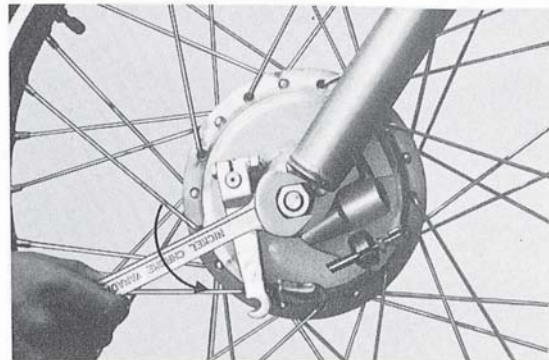

Fig. 5-1-4

- 4) Loosen the front wheel axle lock bolt.

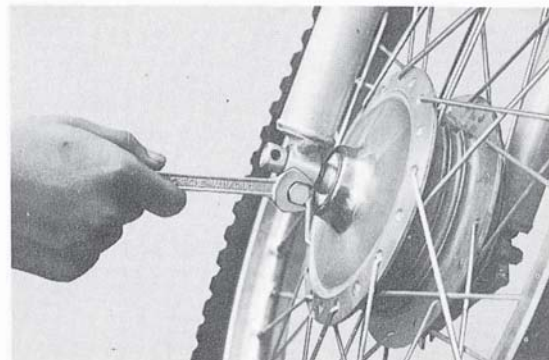

Fig. 5-1-5

- 5) Remove the front wheel axle by simultaneously twisting and pulling out on the axle.

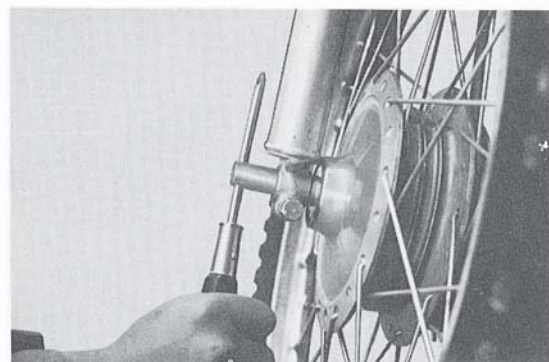

Fig. 5-1-6

## CHASSIS - Front Wheel

- 6) Raise the front of the machine and set it on a box. Then remove the wheel assembly.



Fig. 5-1-7

### B. Checking

- 1) Run out of the rim

As shown in Fig. 5-1-8, measure the runout of the rim with a dial gauge. Run out limits : 2 mm. (0.07 in.) or less.

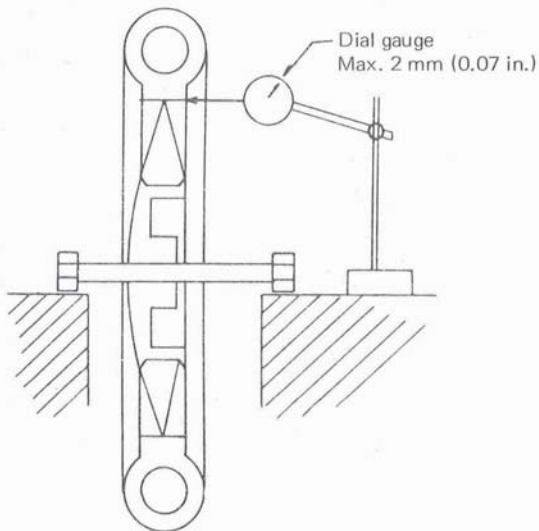

Fig. 5-1-8

- 2) Brake shoe

Measure the outside diameter at the brake shoe with slide calipers. If it measures less than 104 mm. (4.09 in.), replace it. Smooth out a rough shoe surface with sandpaper or with a file.

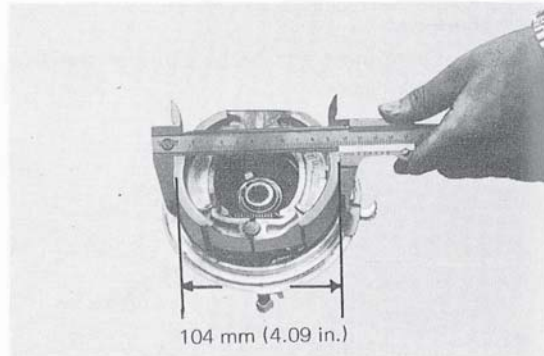

Fig. 5-1-9

- 3) Brake drum

Oil or scratches on the inner surface of the brake drum will impair braking performance or result in abnormal noises. Clean or smooth out the surface with a rag soaked in lacquer thinner or with sandpaper.

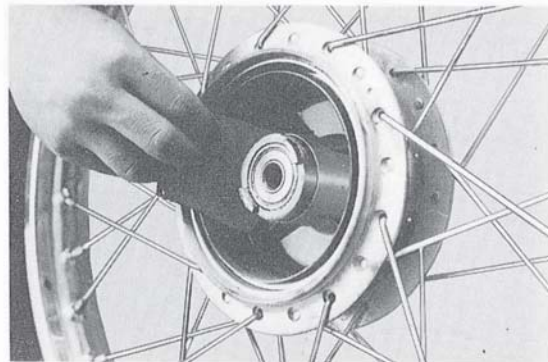

Fig. 5-1-10

- 4) Check the spokes. If they are loose or bent, replace or tighten them. If the machine is ridden in rough country often, or raced, the spokes should be checked regularly.

- 5) Repairing the brake shoe  
If the brake shoe has uneven contact with the brake drum or scratches, smooth out the surface with sandpaper or hand file.

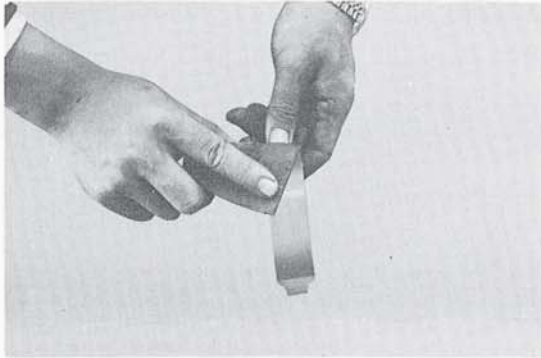

Fig. 5-1-11

- 6) If the tire is excessively worn, replace it.
- 7) Regularly check the tires for damage.
- 8) If the bearings allow excessive play in the wheel or if it does not turn smoothly, replace the bearing.
- 9) Replace a bent or damaged front wheel axle.
- 10) If the tooth surface of the helical speedometer drive gear is excessively worn, replace it.
- 11) Check the lips of the seals for damage or warpage. Replace if necessary.

#### Replacing the Wheel Bearing

- a. First clean the outside of the wheel hub.
- b. Insert the bent end of the special tool (as shown in Fig. 5-1-13) into the hole located in the center of the bearing spacer, and drive the spacer out from the hub by tapping the other end of the special tool with a hammer. (Both bearing spacer and space flange can easily be removed.)
- c. Then push out the bearing on the other side.
- d. To install the wheel bearing, reverse the above sequence. Be sure to grease the bearing before installation and use the bearing fitting tool (furnished by Yamaha.).

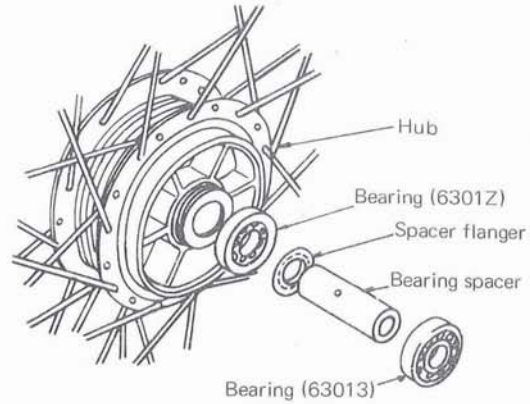
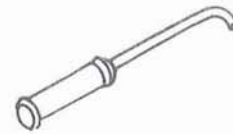

Fig. 5-1-12



Insert the bent end of the special tool into the hole located in the center of the bearing spacer.

Fig. 5-1-13

5-2. Rear Wheel

The rear wheel is 18-in. size, and the rear tire is the 3.00-18" Trials Universal. The single leading shoe type brake is 130 mm. x 28 mm. (5.12 x 1.10 in.) in size. A labyrinth seal between the wheel hub and the brake plate is provided to prevent water and dust leakage. The brake tension bar is of link

design to minimize the shifting of the brake cam lever position when the rear swing arm is moving up and down. The rear fender is steel, and rubber mounted on the frame. It is also wide enough to protect the engine unit from dust and water.

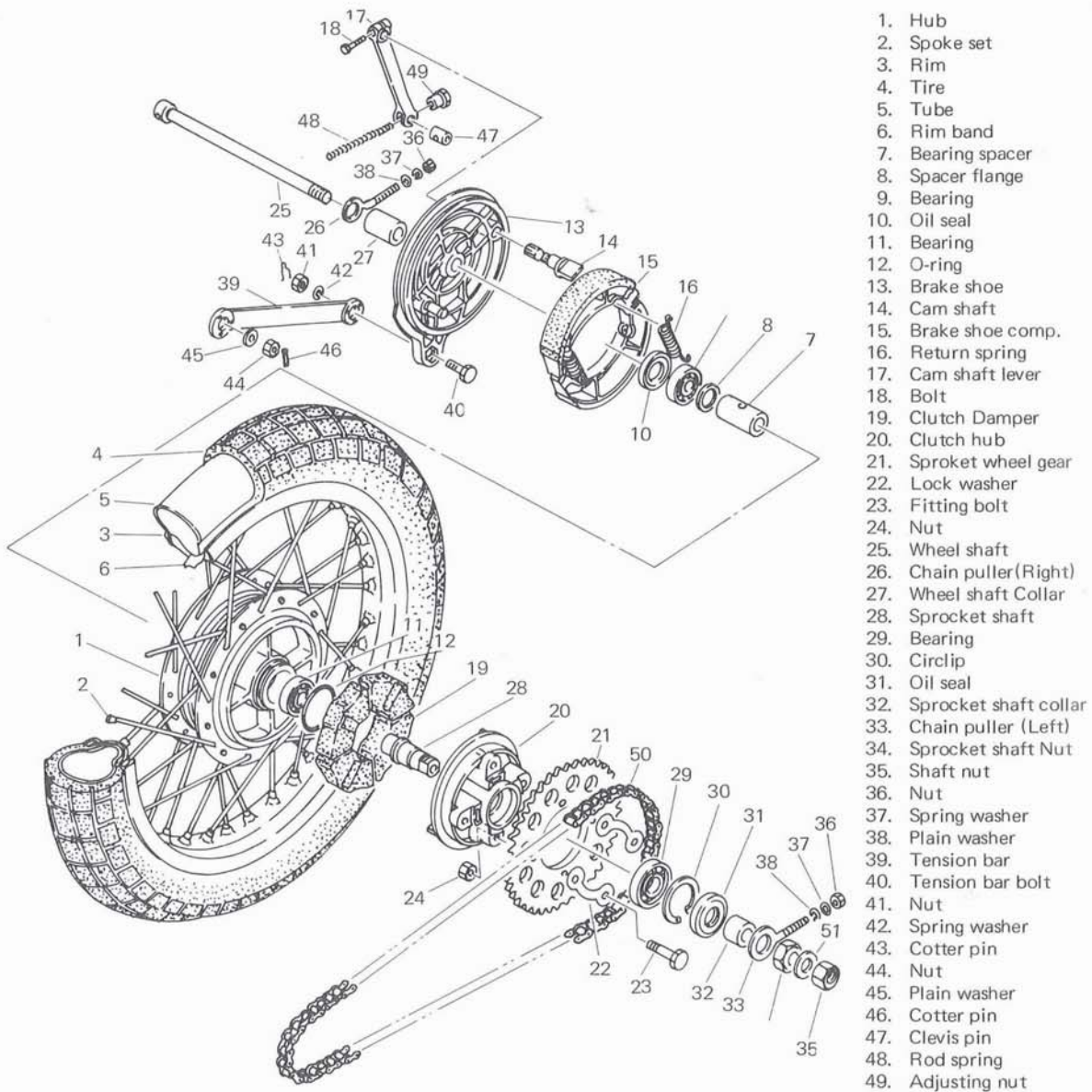

Fig. 5-2-1



A. Removal

- 1) Remove the tension bar and brake rod from the rear shoe plate.

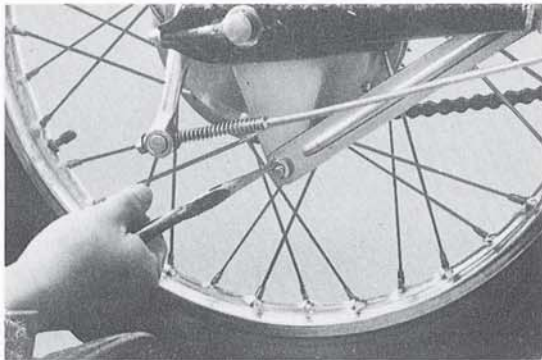

Fig. 5-2-2

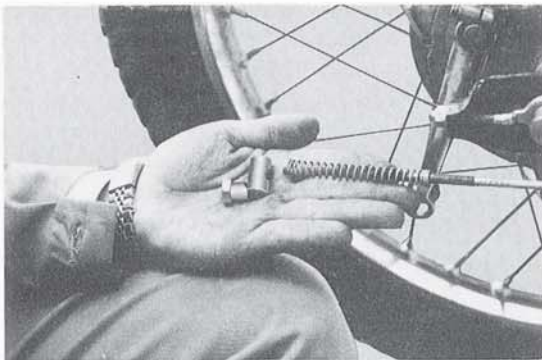

Fig. 5-2-3

- 2) Loosen the chain tension adjusting nuts and bolts on both right and left sides.

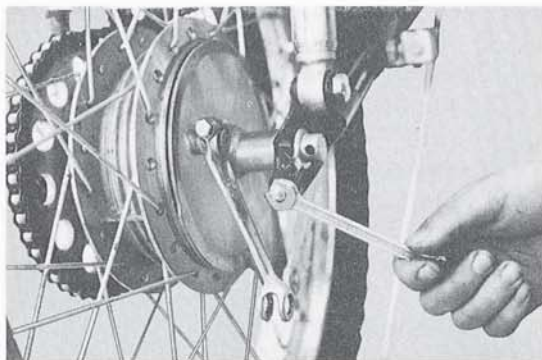

Fig. 5-2-4

- 3) Remove the rear wheel shaft nut.



Fig. 5-2-5

- 4) Pull out the rear wheel shaft by striking it with a plastic tip hammer.



Fig. 5-2-6

- 5) Remove the right-hand chain adjuster and distance collar.

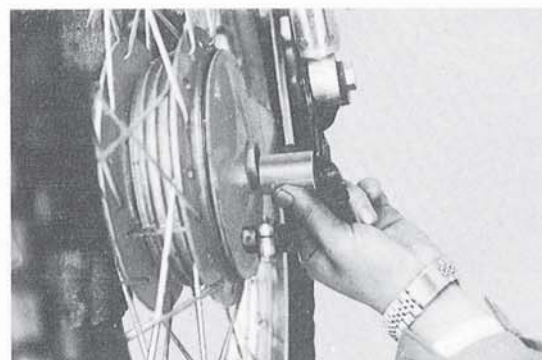

Fig. 5-2-7



- 6) Remove the rear brake plate.

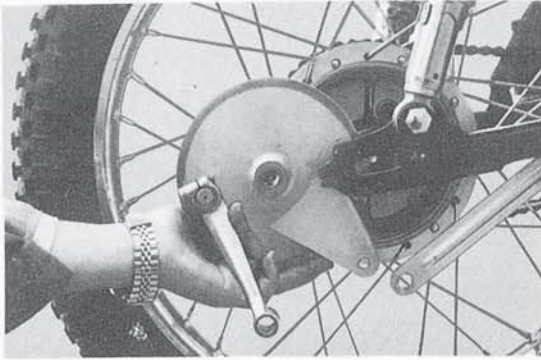

Fig. 5-2-8

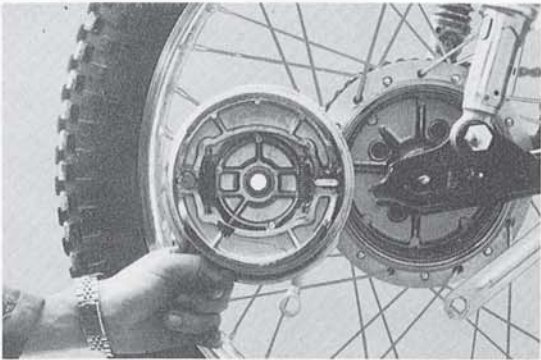

Fig. 5-2-9

- 7) Lean the machine to the left and remove the rear wheel assembly.

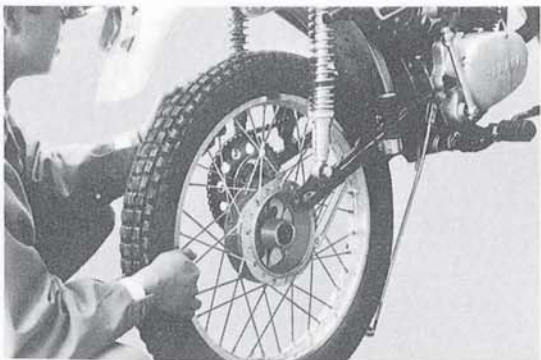

Fig. 5-2-10

#### Replacing the Wheel Bearing

Replace the wheel bearing in the same way as the front wheel bearing.

#### Replacing Tires

##### 1) Removal

- a. Remove the valve cap and lock nut (12 mm.) from the tire valve, and deflate the tire.
- b. Remove the tire from the wheel rim by the use of two tire levers. (Exercise care to avoid damaging the inner tube with the levers.)

It is noted that to remove the inner tube, one side of the tire should be pried out of the wheel rim.

##### 2) Installation

- a. Insert the tube between the tire and the wheel rim, and inflate the tube. Be sure that the valve stem is directed toward the wheel shaft. At this time the tire is still halfway off the rim.
- b. Force the tire completely back on the wheel rim by the use of tire levers. For this operation, it is advisable that the bead on the other side of the tire be pushed in toward the rim flange.
- c. To avoid pinching the tube between the tire and the rim, tap the tire with a hammer as the tire is partially inflated.
- d. Tighten the tire valve lock nut, and inflate the tire to the recommended pressure, then install the valve cap.

#### B. Inspection

- 1) Run out of the rim  
Check the rim for run out in the same way as the front wheel. Maximum limit of runout ..... 2 mm. (0.07 in.) or less.
- 2) Brake shoe  
Check the brake shoe in the same way as the front wheel. Minimum limit ..... 124 mm. (4.9 in.)
- 3) Brake drum  
Check the brake drum in the same way as the front wheel.
- 4) The spokes are measured in the same way as the front wheel. A loose spoke should be tightened.
- 5) If the bearing has excessive play or it does not turn smoothly, replace it.
- 6) If the tire or the pattern is worn out, replace the tire.
- 7) If the lip of the oil seal is damaged or warped, replace it.

**5-3 Rear Sprocket Wheel**

**A. Removal**

- 1) Disconnect the chain joint and remove the chain.



Fig. 5-3-1

- 2) Remove the sprocket.

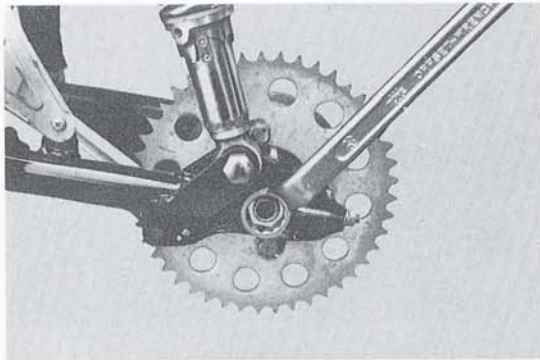

Fig. 5-3-2

**B. Checking and Adjustment**

The rear wheel sprocket is installed on the clutch hub. To replace the sprocket, take the following steps.

- 1) Removing the sprocket
  - a. Bend the lock washer ears flat.

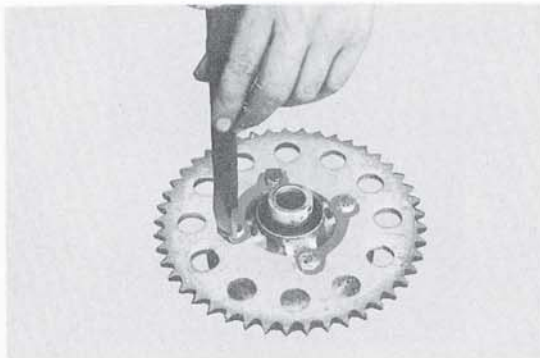

Fig. 5-3-3

- b. Remove the sprocket mounting bolts.

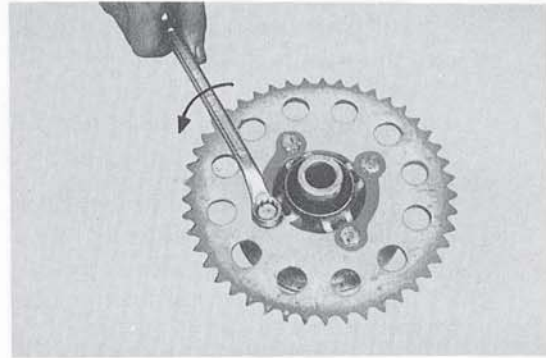

Fig. 5-3-4

- 2) Checking
 

Check the lock washer and hexagonal bolt for breakage and damage. If the lock washer is not bent over the hexagon bolt head, or is broken, or if the bolt is loose, the sprocket can come loose. Make sure that both lock washers and the mounting bolts are tight.

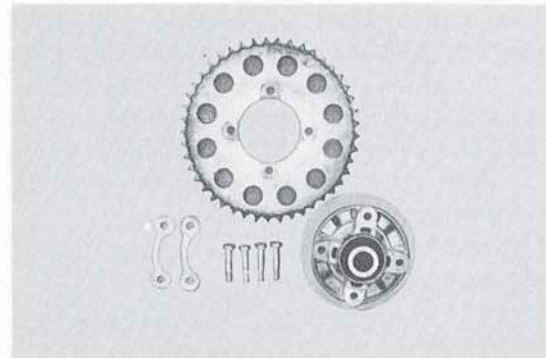

Fig. 5-3-5

### 5-4. Tires and Tubes

- 1) Normal tire pressure  
Though tire pressure is the rider's choice, the standard tire pressure is as follows.
  - a. On-the-road riding  
Front ..... 1.0 kg./cm<sup>2</sup>. (14 lbs./in<sup>2</sup>.)  
Rear ..... 1.2 kg./cm<sup>2</sup>. (17 lbs./in<sup>2</sup>.)

When the tire pressure is reduced below the specified value because of some reason, the tire may slip around the rim. To prevent this slipping of the tire, bead stoppers should be used.

- 2) Remove the inner tube cap bolt.  
You must loosen the arrow marked pinch bolt before the cap bolt is loosened.

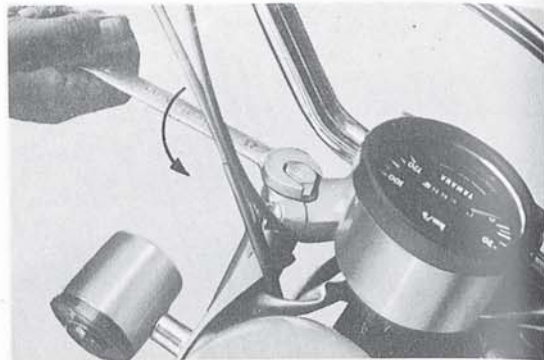

Fig. 5-5-2

- 3) Loosen the inner tube pinch bolt on the underbracket.

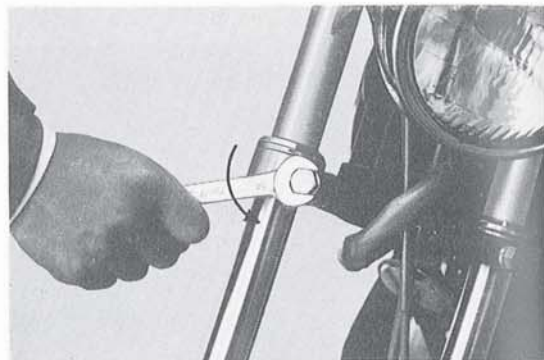

Fig. 5-5-3

- 4) Pull the outer tube downward

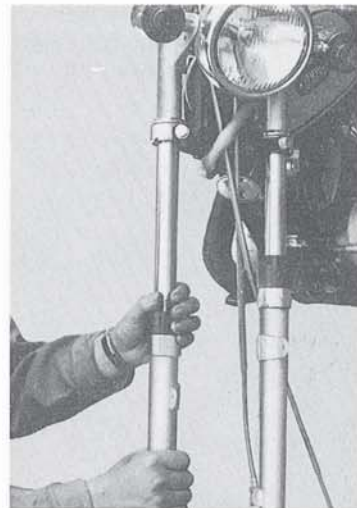

Fig. 5-5-4

### 5-5. Front Forks

The HT1-B is equipped with competition designed telescopic double dampening front forks. These specially designed front forks provide excellent riding comfort along with handling superiority. The maximum stroke travel is almost 120 mm. (4.7 inches).

The combination of fork stability and long stroke travel provides safety and handling ease for the rider over even the roughest terrain. This front fork design also reduces weight, eases maintenance, and gives functional and attractive appearance. The simplicity and dependability of the front forks is provided by the installation of the fork spring inside of the fork tube.

The 125ATI-C front fork can be used for the HT1-B without modification.

#### A. Removal

- 1) Remove the front fender  
The light-weight aluminum front fender is rubber-mounted.

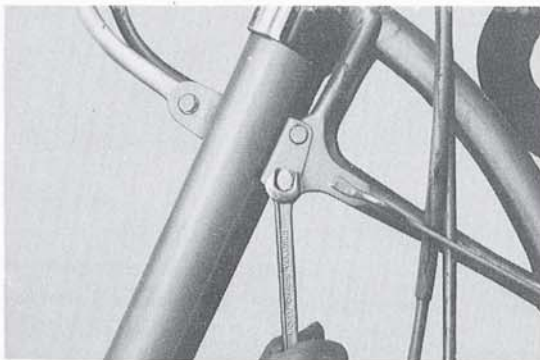

Fig. 5-5-1

- B. Disassembling the Inner and Outer Tubes  
1) Drain the oil from the fork

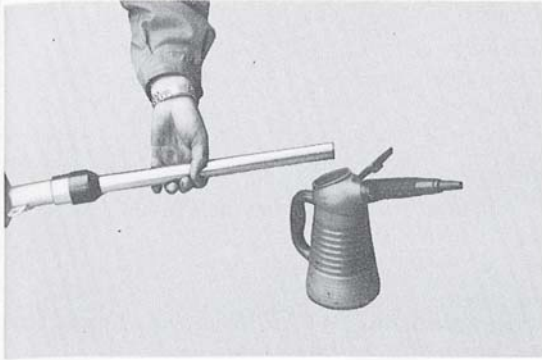

Fig. 5-5-5

- 2) Place a rubber sheet or tire tube around the outer tube nut, and wind a rope of outer tube nut wrench and turn it counterclockwise, then remove the nut. The inner tube can be separated from outer.

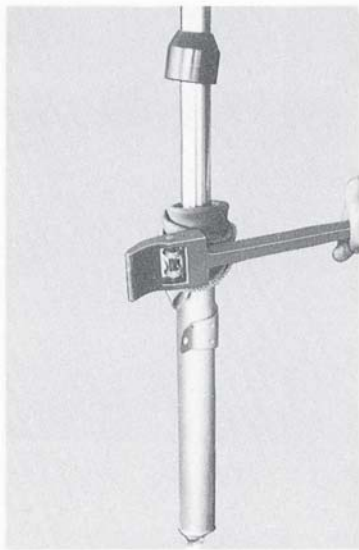

Fig. 5-5-6

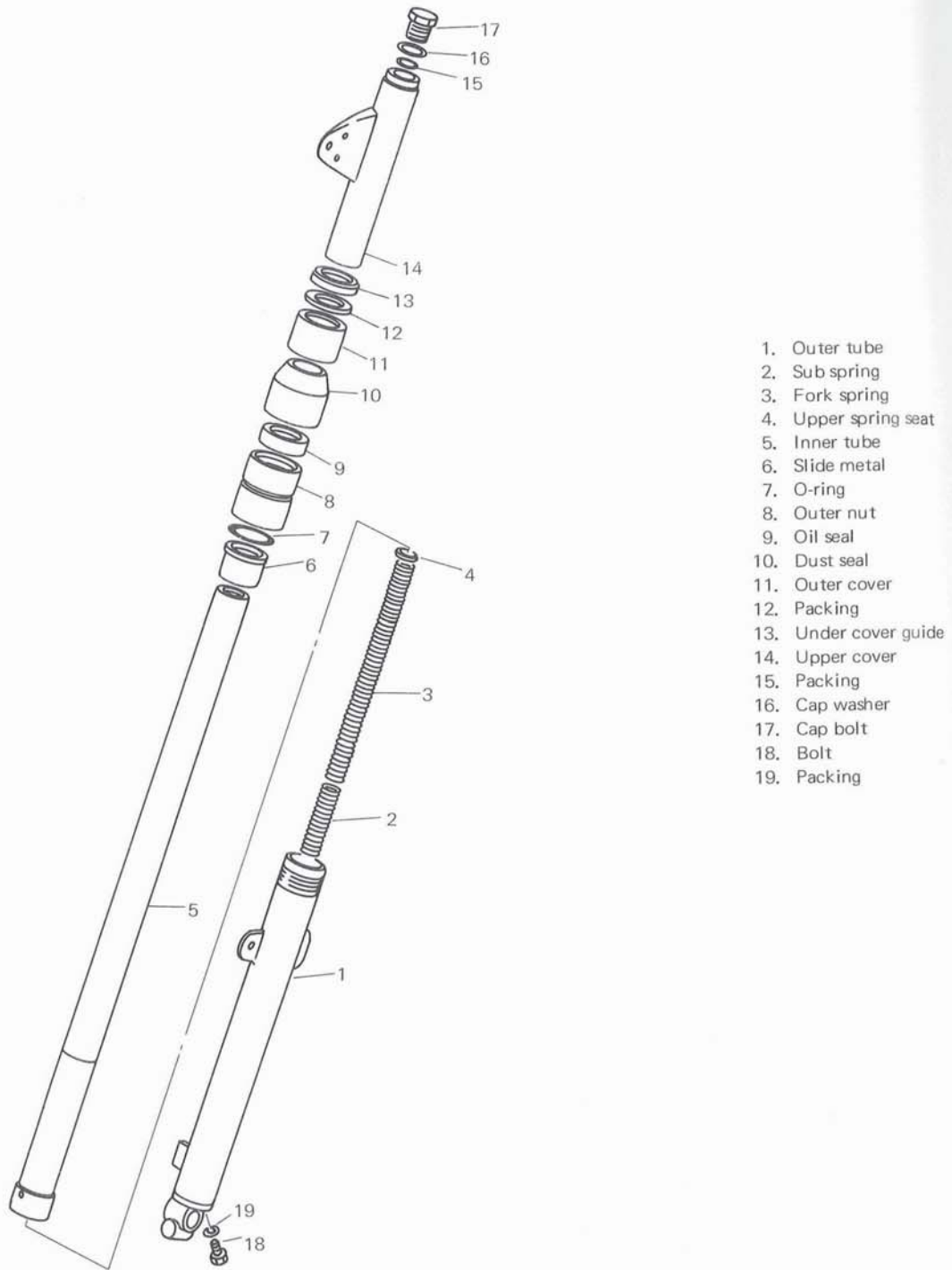

Fig. 5-5-7 Front Exploded View

**C. Checking**

## 1) Inner tube

Check the inner tube for bends or scratches. If the bend is slight, it can be corrected with a press. It is recommended, however, to replace the tube if possible.

## 2) Oil seal

When disassembling the front fork, replace the oil seal in the outer tube nut.

**D. Assembling**

1) When assembling the front fork, reverse the order of disassembly. Check if the inner tube slides in and out smoothly.

## 2) Installing the front fork on the frame

a. Bring up the front fork to the correct position and tighten the under bracket mounting bolt.

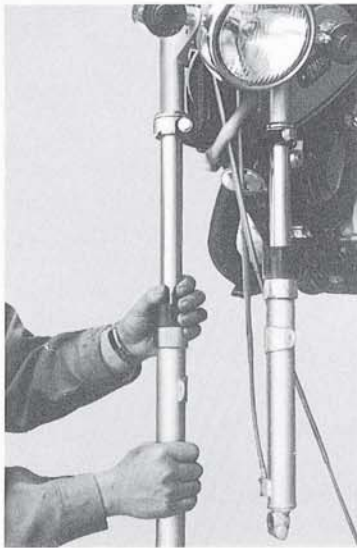

Fig. 5-5-8

b. Pour oil into the inner tube through the upper end opening. Front fork oil: Motor oil 10W/30 132~147 cc (4.5~5.0 fl. oz.) per fork leg.

c. Install the cap bolt.

**5-6. Rear Shocks**

The rear shocks have a maximum stroke of 80 mm. (3.15 in.). The rear cushion features superb damping and 3-position adjustable springs, that allow the rider to adjust the rear shocks to suit any riding condition.

It is possible to use the AT1 rear cushions for the HT1-B without modifying them.

**A. Checking the Condition of the Damping Units.**

1) Remove the rear shock assembly.

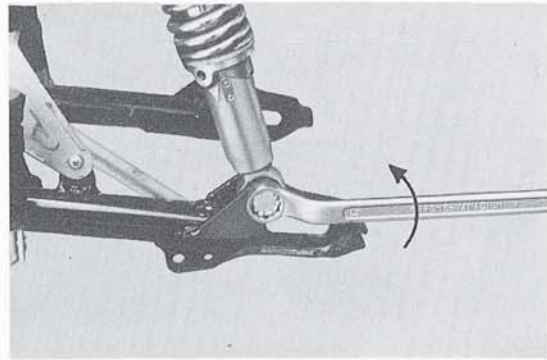
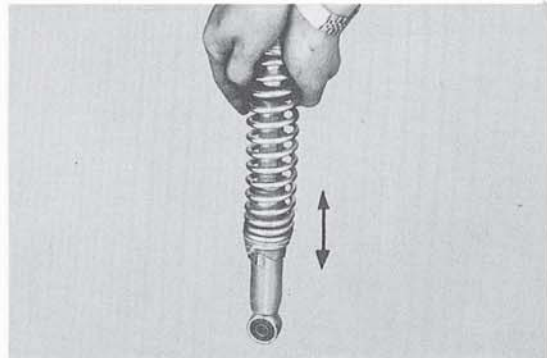

Fig. 5-6-1

2) Compress the shock by applying weight as shown in Fig. 5-6-2, and release it.

If the shock quickly restores halfway and then slowly returns to the original position after it reaches 10 mm. (3/8 in.) before the original position, the rear shocks are in good condition.

But if the cushion returns quickly to the original position, check the cushion for oil leakage, and replace the assembly if it leaks.



**5-7. Gas Tank**

The front of the tank is held to the frame by a hook on the tank that slips over a pin, and the rear is held by a rubber band. Tank capacity is 6.5 litres (1.9 U.S. gals.)

**A. Removing**

- 1) Set the fuel cock lever at the "Stop" position and disconnect the fuel line at the petcock.

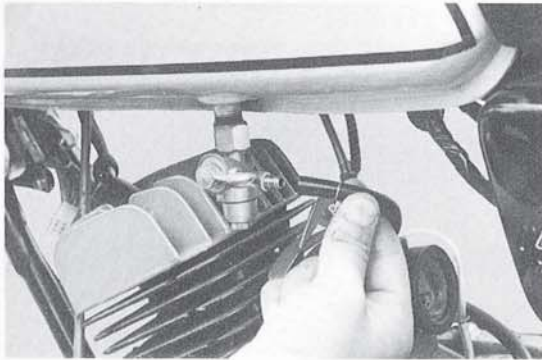

Fig. 5-7-1

- 2) Open the seat and disconnect the strap.

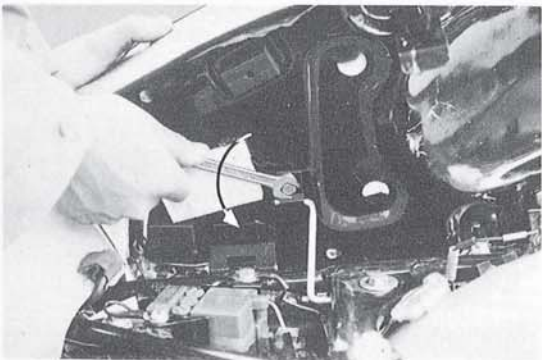

Fig. 5-7-2

- 3) Remove the rubber band.

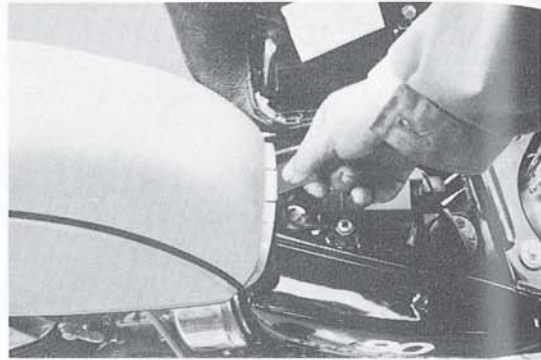

Fig. 5-7-3

- 4) Remove the gas tank.



Fig. 5-7-4

**5-8. Rear Swing Arm**

The rear swing arm is made of steel tube that improves the strength and torsional rigidity. The pivot employs permanently lubricated bearings.

**A. Removing**

- 1) Remove the chain case mounting bolts.



Fig. 5-8-1

- 2) Remove the rear swing arm shaft nut, pull out the shaft, and remove the rear swing arm.

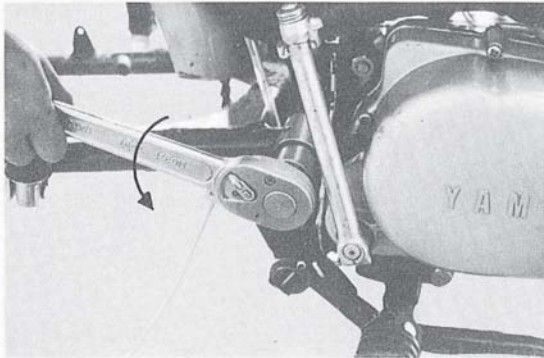

Fig. 5-8-2

- 2) Insert the bushing as indicated in Fig. 5-8-4, and check it for play. If the play is excessive, replace the bushing.

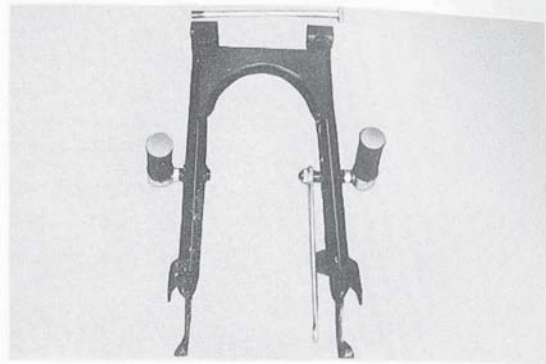

Fig. 5-8-4

**B. Checking**

- 1) Check the play of the rear swing arm by shaking it as shown in Fig. 5-8-3, with the rear swing arm installed. If the play is excessive, replace the rear swing arm bushing or the rear swing arm shaft.

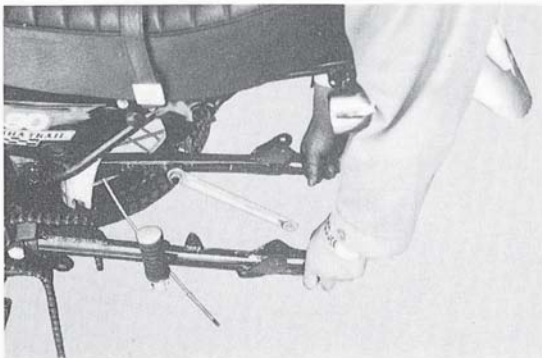

Fig. 5-8-3

- 3) Grease the rear arm shaft periodically.

**Replacing Rear Swing Arm Bushings**

On motorcycles being used only for on-the-street riding, rear swing arm bushings should be replaced every 10,000 km. (6,000 miles). The same may not apply to those used for racing or rough riding. Replacement should be made according to machine condition such as excessive play of the rear swing arm, or hard steering (wander, shimmy or rear wheel hop,) or upon request of the customer.



5-9. Steering Head

A. Sectional View of the Steering Head

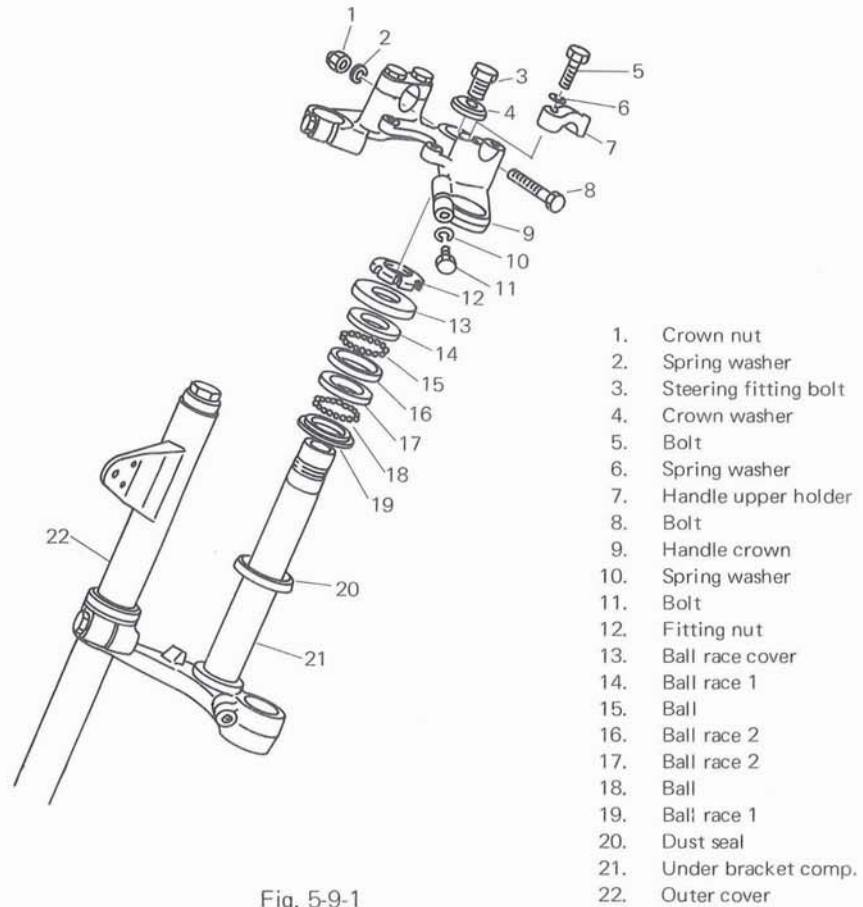

Fig. 5-9-1

B. Checking

1) Ball Races and Steel Balls

Check the ball races and steel balls for pitting or wear. Check them very carefully if the machine has been in long use. If they are worn or cracked, replace all of them, because defective ball races or steel balls adversely affect the maneuverability of the machine. Replace any ball race

having scratches or streaks resulting from wear. Clean and grease the balls and races periodically.

**Note:**

Do not use a combination of new balls and used races or vice versa. If any of these are found defective, replace the whole ball and race assembly.

### 5-10. Oil Tank, Battery Box and Tool Box

The oil tank is located on the left side under the seat. It is designed to be as narrow as possible so that it will not contact the rider's lower limbs when he stands upright on the footrests. To fill the autolube oil tank, lift the seat and the tank cap will be exposed. Oil tank capacity ..... 1.2 liters (1.2 u.s qts)

The battery box is located right under the seat. And the air cleaner case is located under the fuel tank.

to the frame. The engine guard is bolted to the frame to protect the entire crankcase ..... covering from the exhaust system to the drain plug.

### 5-11. Frame

The double cradle-type frame is made of high tension steel tubes that provide strength, rigidity and light weight. Other dimensional features include high ground clearance, narrow width, and long wheelbase. The engine is bolted to the frame at three positions. The caster is measured at  $60.50^{\circ}$ .

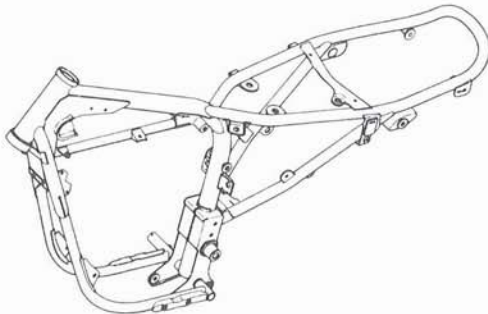

Fig. 5-11-1

### 5-12. Handlebars

The upswept type longer handlebars are ideal for motocross events and are provided with deep-cut pattern grips to prevent hand slippage. The lever holder is provided with adjusting screws for clutch cable and brake cable free play.

The meter bracket is mounted on the ends of the handle crown, to carry the speedometer on its left side and the tachometer on its right side.

### 5-13. Miscellaneous

The footrest is made of a single steel tube extending under the lower part of the frame, and bolted

CHAPTER 6. ELECTRICAL SYSTEM

6-1. Description

The HT1-B employs a flywheel magneto for its ignition system, same as in the AT1.

6-2. Table of Component Parts

Parts	Manufacturer	Model & Type	Remarks
Flywheel magneto	Hitachi Ltd.	F-130-07	
Spark plug	NGK	B-7HZS	
Headlight	Koito Mfg.	6V 25/25W Neutral pilot light 6V 3W	
Speedometer	Nippon Seiki	Meter light 6V 3W	Is interchangeable with DT1
Handlebar switch	Asahi Denso		Is interchangeable with DT1
Ignition coil	Hitachi Ltd.	CM61-50	
Horn	Nikko Kinzoku	GF-6	
Battery	Nippon Battery	6N2-2A-3	
Rectifier	Mitsubishi Elec.	DS10HJ	Is interchangeable with DT1
Fuse	Osachi Mfg.	10A x 2	Is interchangeable with DT1
Stop switch	Asahi Denso		
Taillight	Koito Mfg.	6V 17W/5.3W	

6-3. Connection Diagram

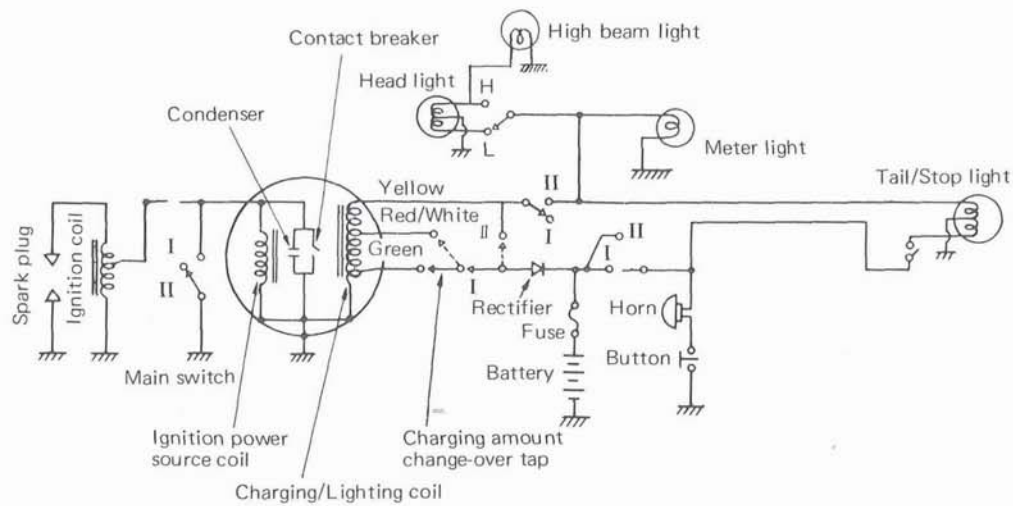

Fig. 6-3-1

### 6-4. Ignition System—Function and Service

#### 1. Function

The ignition system consists of the components as shown in Fig. 6-4-1. As the flywheel rotates, the contact breaker points begin to open and close, alternately. This make-and-break operation develops an electromotive force in the ignition power source coil, and produces a voltage in the ignition coil primary windings. The ignition coil is a kind of transformer, with a 1:50 turn ratio of the primary to the secondary winding. The voltage (150~300V) which is produced in the primary coil, is stepped up to 12,000~14,000V by mutual-induction and the electric spark jumps across the spark plug electrodes.

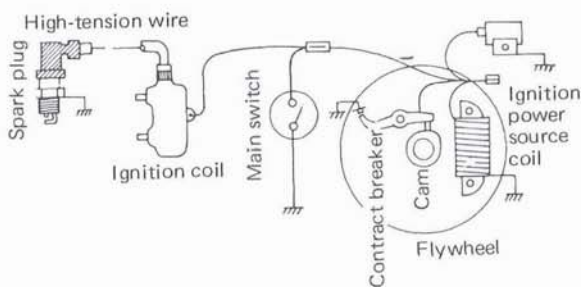

Fig. 6-4-1

### 6-5. Ignition Timing

Remove the spark plug and screw the dial indicator holder into the plug hole. Next, insert the dial indicator into the holder. Bring the piston up to T.D.C. and set the zero on the dial face to line up exactly with the dial indicator needle. The crankshaft should then be turned backwards, so that the piston travels down past 1.8 mm B.T.D.C. and slowly brought back up to precisely 1.8 mm B.T.D.C. (This removes any slack in the gears). Adjust the points so that they are just beginning to open with the piston in this position. A low resistance point checker (100 Ohms or less) should be used to determine the opening and closing of the ignition points.

Ignition Timing, 1.8 mm. B.T.D.C.

Maximum ignition point gap 0.3 to 0.4 mm. (0.012"—0.015")

### 6-6. Ignition Coil

Primary coil resistance value .....  
 $4.9\Omega \pm 10\%$  (20°C or 68°F)  
 Secondary coil resistance value .....  
 $11\text{ k}\Omega \pm 10\%$  (20°C or 68°F)

(For measuring methods, refer to Fig. 6-6-1)

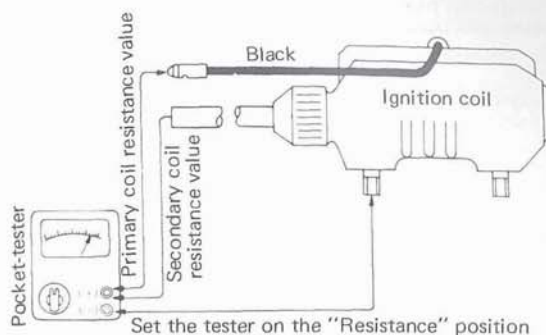

Fig. 6-6-1

#### Spark Test:

Remove the spark plug from the cylinder head and reconnect the high voltage lead. Then hold the spark plug approximately 7 mm away from the head and see if it sparks as you crank the kickstarter.

If it sparks at 7 mm. or so, and has blue white color, the ignition coil should be considered to be in good condition.

### 6-7. Condenser

The condenser instantly stores a static electric charge as the contact breaker points separate, and the energy stored in the condenser discharges instantly when the points are closed. If it were not for the condenser, an electric arc would jump across the separating contact points, causing them to burn.

Burned contact points greatly affect the flow of current in the primary winding of the ignition coil. If the contact points show excessive wear, or the spark is weak (the ignition coil is in good condition), check the condenser.

Insulation resistance tests should be conducted by connecting the tester as shown in Fig. 6-7-1. If the pointer swings fully and the reading is more

than  $3M\Omega$ , the insulation is in good condition. If the insulation is faulty, the pointer will stay pointing at the uppermost reading, indicating very little resistance.

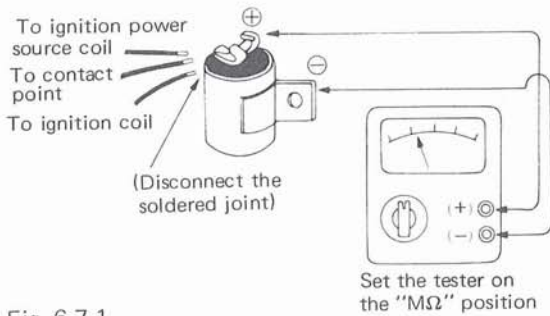

Fig. 6-7-1

**Note:**

After this measurement, the condenser should be discharged by connecting the positive and negative sides with a thick wire.

Capacity tests can be performed by simply setting the tester to the condenser capacity. The tester should be connected with the condenser in the same way as in the case of the insulation resistance test. Before this measurement, be sure to set the tester correctly.

If the reading is within  $0.22 \mu F \pm 10\%$ , the condenser capacity is correct.

**6-8. Charging System**

The charging system consists of the flywheel magneto (charging and lighting coils), rectifier, and battery.

**1. Flywheel Magneto**

As the flywheel rotates, an alternating current is generated in the charging and, lighting coils and converted to a half-wave current by means of a silicon rectifier.

This half-wave current charges the battery.

Charging Capacity (Daytime)

- Green lead: Charging begins at 3,000 rpm.
- 2.0 A or less at 8,000 rpm.
- White/Red: 4.0 A or less at 8,000 rpm.

Lighting Capacity (Night time)

(With normal loads and normal wiring.)

- 5.5V or more at 2,500 r.p.m.
- 8.0V or less at 8,000 r.p.m.

\* The charging and lighting capacity is obtained when the battery is fully charged. If the battery is in a low state of charge and low in voltage, the charging rate will be not exactly the same as above. However, it is desirable that the figures are as close as possible.

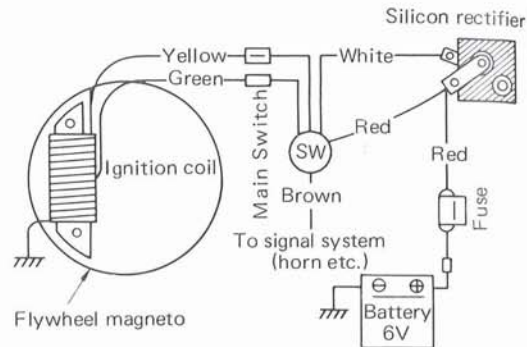

Fig. 6-8-1

**2. Silicon Rectifier**

The alternating current, which is generated by the flywheel magneto, is rectified and charged to the battery. For this rectification, a single-phase halfwave silicon rectifier is employed.

Characteristics: Rated output – 4A,  
Rated peak inverse voltage  
400V

Polarity:



Fig. 6-8-2

a. **Checking the Silicon Rectifier**

For measurements, an ohmmeter can be used.

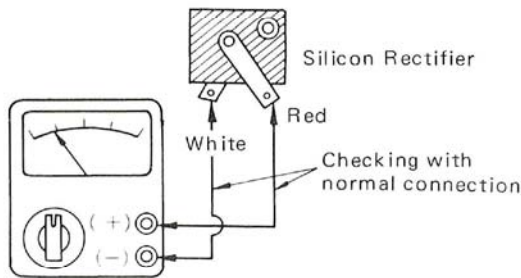

(Set the tester on Resistance.)

Fig. 6-8-3

**Checking with Normal Connection**

Connect the tester's red lead (+) to the silicon rectifier's red terminal, and connect the tester's black lead (-) to the rectifier's white terminal.

Standard value:  $9 \sim 10\Omega$

If the tester's pointer will not swing back over from the scale, the rectifier is defective.

**Checking with Reversal Connection**

Connect the tester the other way around.

Standard value: If the pointer will not swing, the rectifier is in good condition. If the pointer swings, the rectifier is faulty.

**3. Operational Note**

The silicon rectifier can be damaged if subjected to overcharging. Special care should be taken to avoid a short circuit and/or incorrect connection of the positive and negative leads at the battery. Never connect the rectifier directly to the battery to make a continuity check.

**6-9. Battery**

The battery is a 6 volt-2 AH unit that is the power source for the horn and stoplight. Because of the fluctuating charging rate due to the differences in engine R.P.M.s, the battery will lose its charge if the horn and stoplight are excessively used. The charging of the battery begins at about

3,000 R.P.M. Therefore, it is recommended to sustain engine R.P.M.s at about 3,000 to 4,000 R.P.M. to keep the battery charged properly. If the horn and stoplight are used very often, the battery water should be checked regularly as continuous charging will dissipate the water. If the battery will not retain a charge (and the battery is in good condition) the White/Red wire of the flywheel magneto can be connected to the green wire of the wiring harness. This will increase the charging rate. But if the machine is ridden for long periods of time at high speeds with this wiring connection, the battery may be overcharged and damaged.

**1. Checking**

- 1) If sulfation occurs on plates due to lack of battery electrolyte, showing white accumulations, the battery should be replaced.
- 2) If the bottoms of the cells are filled with corrosive material falling off plates, the battery should be replaced.
- 3) If the battery shows the following defects, it should be replaced.
  - The voltage will not rise to a specific value even after long hours charging.
  - No gassing occurs in any cell.
  - The 6V battery requires a charging current of more than 8.4 volts in order to supply a current at a rate of 1 amp. per hour for 10 hours.

**2. Service Life**

The service life of a battery is usually 2 to 3 years, but lack of care as described below will shorten the life of the battery.

- 1) Negligence in re-filling the battery with electrolyte.
- 2) Battery being left discharged.
- 3) Over-charging by rushing charge.
- 4) Freezing.
- 5) Feeding of water or sulfuric acid containing impurities when re-filling the battery.

**3. Storage**

If any motorcycle is not used for a long time, remove the battery and have it stored by a battery service shop. The following instructions should be observed by shops equipped with chargers.

- 1) Recharge the battery.
- 2) Store the battery in a cool, dry place, and avoid temperatures below  $0^{\circ}\text{C}$ . ( $32^{\circ}\text{F}$ )

## CHASSIS-Checking the Main Switch (removed from the chassis), Spark Plug

- 3) Recharge the battery before mounting it on the motorcycle.

### 4. Service Standards

Battery Spec		6V-2AH
Electrolyte-Specific gravity and 1.26–1.27, 110 c.c. quantity		At full charge
Initial charging current	0.2A for 25 hours	Brand new motorcycle
Charging current	0.2A for 13 hours (Charge until specific gravity reaches 1.26–1.27)	When discharged
Refilling of electrolyte	Distilled water up to the max. level line.	Once a month

### 6-10. Checking the Main Switch (removed from the chassis)

Key "O" position (Off)

Black ↔ Switch body

Key "I" position  
(for day)

Green ↔ White

Red ↔ Brown

Key "II" position  
(for night)

Yellow ↔ White

White ↔ Blue

Red ↔ Brown

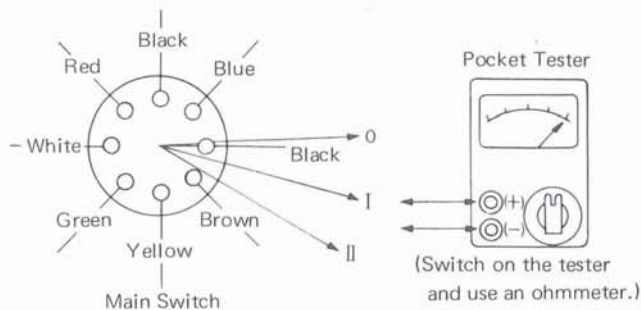

Fig. 6-10-1

If the readings or the above six measurements are nearly  $0\Omega$ , and no short-circuit is noticed between the terminals, as well as between the lead terminal and the switch body, the main switch is in good condition.

### 6-11. Spark Plug

The life of a plug and its discoloring vary, according to the habits of the rider. At each periodic inspection, replace burned or fouled plugs with suitable ones determined by the color and condition of the bad plugs. One machine may be ridden only in urban areas at low speeds, whereas another may be ridden for hours at high speeds, so confirm what the present plugs indicate by asking the rider how long and how fast he rides, and recommend a hot, standard, or cold plug accordingly. It is actually economical to install new plugs

every 3,000 km (2,000 miles) since it will tend to keep the engine in good condition and prevent excessive fuel consumption.

1. How to "read" spark plug (condition)
  - a. Best ... When the porcelain around the center electrode is a light tan color.
  - b. If the electrodes and porcelain are black and somewhat oily, replace the plug with a hotter-type for low speed riding.
  - c. If the porcelain is burned white and/or the electrodes are partially burned away, replace the plug with a colder-type for high speed riding.
2. Inspection
 

Instruct the rider to:

Inspect and clean the spark plug at least once a month or every 1,000 km. (600 miles) Clean the electrodes of carbon and adjust the electrode gap to 0.5~ mm. (0.023 in.) Be sure to

rode gap to 0.5~0.6 mm. (0.023 in.) Be sure to use standard B-8E plug as replacements to avoid any error in reach.

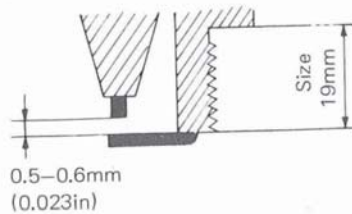

Fig. 6-11-1

## 6-12. Lighting and Signal Systems

The lighting and signal systems consist of the horn and stop light (power source-battery) and the head light, tail light, meter lamps, speedometer.

### 1. Head Light

The head light has two 6V, 25W bulbs, and a 6V, 1.5W neutral pilot light on its top. A beam directing adjusting screw is fitted on the

right side of the light rim so that the horizontal direction of the beam can be adjusted (not vertically).

### 2. Tail Light and Stop Light

A 6V, 5.3W tail light and a 6V, 17W stop light are mounted. The lens of the tail light is provided with reflectors on its three sides—rear, right and left.

### 3. Horn

The horn is a 6V, flat type, and has a tone-volume adjusting nut on its back.

After adjustment is made, apply paint or lacquer to the nut for water proofing purposes.

### 4. Speedometer

A circular type speedometer is mounted on the bracket. For illumination, a 6V, 3W bulb is provided.



**CONVERSION TABLES**

**CONVERSION TABLES**

**LENGTHS**

Multiply	By To Obtain	Multiply	By To Obtain
Millimeters (mm)	0.03937 Inches	Kilometers (km)	0.6214 Miles
Inches (in)	25.4 Millimeters	Miles (mi)	1.609 Kilometers
Centimeters (cm)	0.3937 Inches	Meters (m)	3.281 Feet
Inches (in)	2.54 Centimeters	Feet (ft)	0.3048 Meters

**WEIGHTS**

Kilograms (kg)	2.205 Pounds	Grams (g)	0.03527 Ounces
Pounds (lbs)	0.4536 Kilograms	Ounces (oz)	28.35 Grams

**VOLUMES**

Cubic centimeters (cc)	0.061 Cubic inches	Imperial gallons	277.274 cu.in.
Cubic inches (cu.in)	16.387 c.c.	Liters (l)	1.057 Quarts
Liters (l)	0.264 Gallons	Quarts (qt)	0.946 Liters
Gallons (gal)	3.785 Liters	Cubic centimeters (cc)	0.0339 Fluid ounces
U.S. gallons	1.2 Imperial gals.	Fluid ounces (fl.oz.)	29.57 c.c.
Imperial gallons	4.537 Liters		

**OTHERS**

Metric horsepower (ps)	1.014 bhp.	Foot-pounds (ft-lb)	0.1383 kg-m
Brake horsepower (bhp)	0.9859 ps.	Kilometers per liter (km/l)	2.352 mpg
Kilogram-meter (kg-m)	7.235 ft-lb	Miles per gallon (mpg)	0.4252 km/l

**GAS (FUEL) TO OIL RATIO CHART**

Gas/Oil Ratio	12:1	16:1	20:1	24:1	28:1	32:1	36:1	40:1
Oil (qt) per 1 Gal. Gas	0.33	0.25	0.2	0.2	0.14	0.13	0.11	0.1
Oil (oz) per 1 Gal. Gas	10.7	8.0	6.4	6.4	4.6	4.0	3.6	3.2
Oil (qt) per 5 Gal. Gas	1.66	1.25	1.0	1.0	0.72	0.63	0.55	0.5
Oil (oz) per 5 Gal. Gas	53.5	40.0	32.0	32.0	22.8	20.0	17.8	16.0

(U.S. Gallons)

# Yamaha ENDURO 90 HTI-B Circuit Diagram

Battery circuit	Red
Common circuit	Brown
Magneto (day) circuit	Green
Magneto (night) circuit	Yellow
Light circuit	Blue
Horn circuit	Pink
Earth circuit	Black
Charging circuit	White

Head lamp  
6V 25/25W

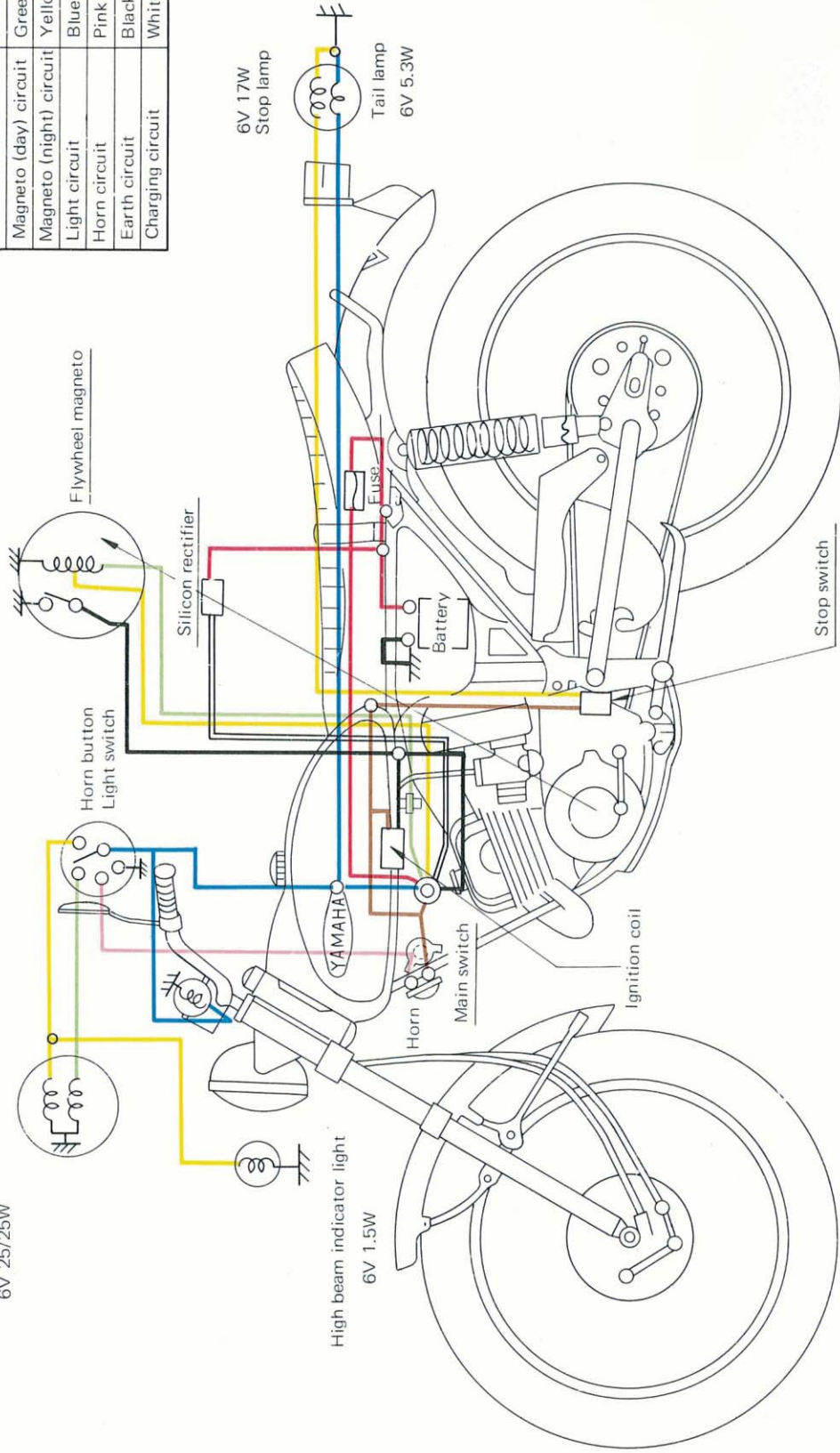

6V 17W  
Stop lamp

Tail lamp  
6V 5.3W

Flywheel magneto

Silicon rectifier

Horn button  
Light switch

Horn

Main switch

Ignition coil

Stop switch

High beam indicator light  
6V 1.5W

Battery

Fuse

YAMAHA