

**YAMAHA**  
**ENDURO**  
**DT250**  
**OWNER'S MANUAL**

438 - 28199 - 10



## NOTICE

Yamaha Motor Company and its U.S. subsidiary, Yamaha International Corporation, are confident you will enjoy your new Yamaha to the utmost.

We have made every effort to provide you with a safe, well engineered and constructed product. This Owner's Manual will acquaint you with several features and maintenance procedures concerning your Yamaha. However, if you are unfamiliar with the product, features or procedures outlined in this booklet we strongly urge you to consult your Authorized Yamaha Dealer for additional information. Please review your owner's warranty guide book thoroughly regarding your warranty obligation.

**DT250 OWNER'S MANUAL**

**1st Printing**

**APRIL, 1973**

**All rights reserved, Yamaha International Corporation  
and/or Yamaha Motor Co., Ltd., Japan.**

**Yamaha International Corporation  
P.O. Box 6600, Buena Park, Cal.**

**P/N LIT-11624-38-02**

## FOREWORD

It is our greatest pleasure that you are now a member of the Yamaha DT250 riders.

The Yamaha DT250, now ready for your use and service, is a motorcycle which has been manufactured by us under the strictest quality control in our Factory.

Naturally, like any other model, proper handling, and daily inspection, adjustment and care are a prerequisite for a successful continuity of the top performance of this model.

This Manual discusses these points to assist you in your best operation and handling of the Yamaha DT250. Your perusal of the various items in this Manual is sincerely requested.



YAMAHA MOTOR CO., LTD.  
SERVICE DEPARTMENT

# CONTENTS

Contents . . . . .	3
General View . . . . .	5
Features . . . . .	6
Yamaha Autolube . . . . .	8
Control Function . . . . .	9
Basic Instruction . . . . .	14
Operation . . . . .	15
Service Tools . . . . .	22
Lubrication and Maintenance Chart . . . . .	22
Servicing . . . . .	27
Warranty Information . . . . .	60
Requirements for a Good Motorcyclist . . . . .	61
Troubleshooting . . . . .	62
Consumer Information . . . . .	63



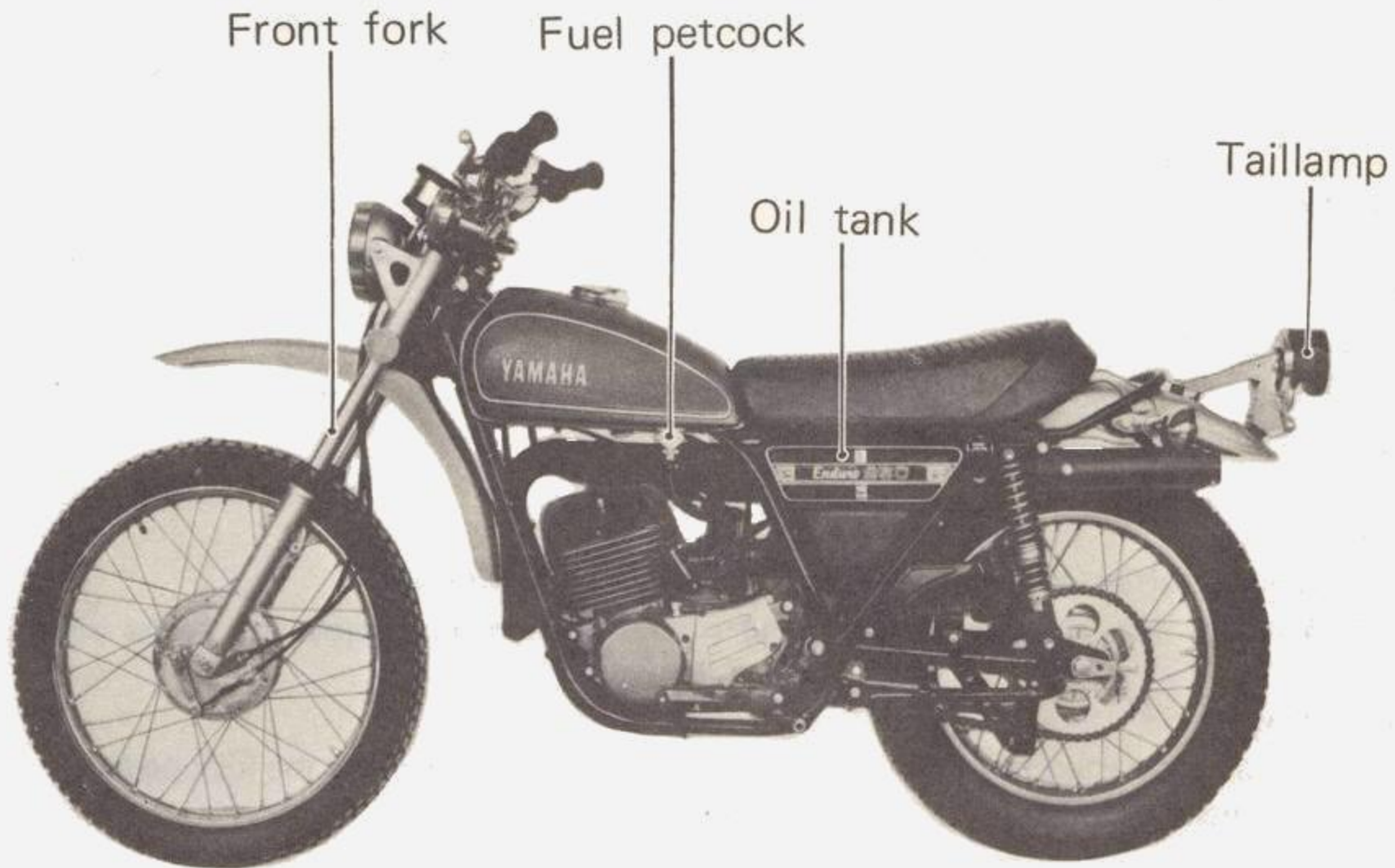

Front fork

Fuel petcock

Oil tank

Taillamp

Left hand side view

## **1. Features**

### **1. "TORQUE INDUCTION" System**

Another new type engine has made its debut! The reed valve has been adopted as a new intake system to Yamaha's ENDURO DT250. This, together with the 7-port cylinder, ensures excellence in steady engine performance from low to high speed running.

### **2. Highly-dependable Yamaha Autolube**

Yamaha Autolube provides superior engine lubrication that extends the service life of the engine.

### **3. Thermal Flow Shock**

The rear cushion employs a "thermal flow shock" to slow the rise of fluid temperature and ensure damping effect.

### **4. Muffler**

The center-up muffler are employed to narrow the axle utmost.

And as a result, you can set-up freely the riding position and enjoy the better riding.

### **5. Easy Starting**

The engine can be started by simply disengaging the clutch and kicking the kick pedal without shifting gears back to neutral. This is a valuable convenience to the rider.

### **6. Powerful Brakes**

Patented waterproof dustproof brake drums provide safe, fade-free braking on wet or dusty roads.



### **7. Adjustable Rear Cushion**

The rear cushions are adjustable to check positions. The rider can adjust spring tension to compensate for varying weights, speeds, and road conditions.

### **8. Front Fork Design**

The Yamaha Enduro DT250 employs a front fork design well-known for its strength and superior handling characteristics. Its use assures the rider of the ultimate suspension for even the roughest terrain.

### **9. Speedometer and Tachometer**

A speedometer and tachometer are standard equipment. The individual units are separately mounted for maximum visibility. An additional feature of the speedometer is an odometer which can be reset by tenths to zero for trip or enduro purposes.

### **10. Tires**

The Yamaha DT250 is fitted with Dunlop Trials Universal tires as standard equipment. This particular tread is one of the most versatile available. It gives maximum trail traction, yet is compatible with road usage.

### **11. Carburetor with built-in starter jet**

Yamaha's carburetor is already well-known for providing easy starting. Equipped with this unique starter jet, the Yamaha DT250 is quick starting under all conditions.

## What is Yamaha Autolube?

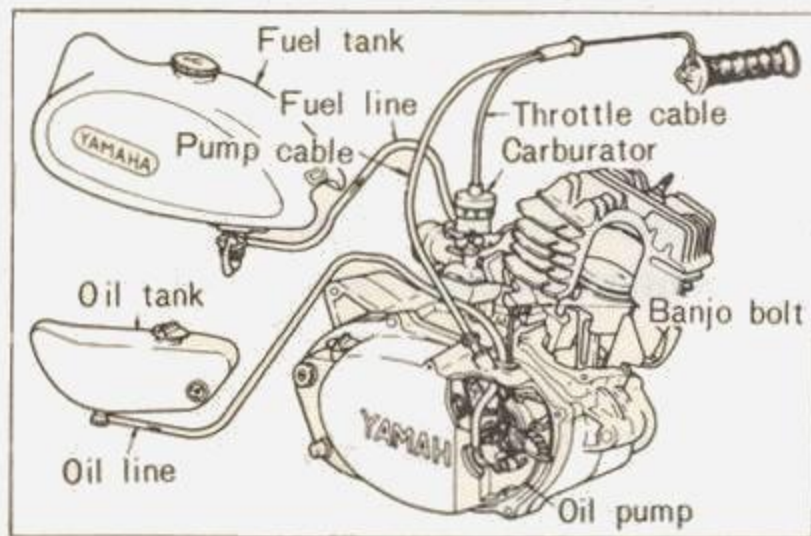

Autolube is the best lubricating system available for 2 stroke of oil injected straight to the engine is controlled by a compact, high-precision oil pump. The pump plunger, driven by a reduction gear, has its output controlled by throttle opening, and engine speed. Because of the wide range of control Autolube offers, precisely the right amount of oil is available at all time. Autolube eliminates a number of major problem unavoidable with premix lubrication. This means both improved performance and reliability.

### Yamaha Autolube Features:

1. Oil consumption is greatly reduced, up to 1/3 less than pre-mix systems.
2. More effective lubrication results because the oil enters the engine in larger size droplets.
3. There is much less unwanted carbon deposited on the spark plug, cylinder head, piston and exhaust system!
4. There is much less exhaust smoke.
5. Refueling is simplified, gas and oil are kept inseparate tanks.
6. Because poor quality oils can easily be avoided, and because the possibility of mismeasuring or inadequately mixing fuel is eliminated, Autolube offers completely consistent lubrication.
7. Longer engine life. The Autolube injection system provides lubricating and cooling oil to the internal moving parts of the engine at all times. Even when the throttle is shut off the engine is receiving lubricating oil.

## Control Function

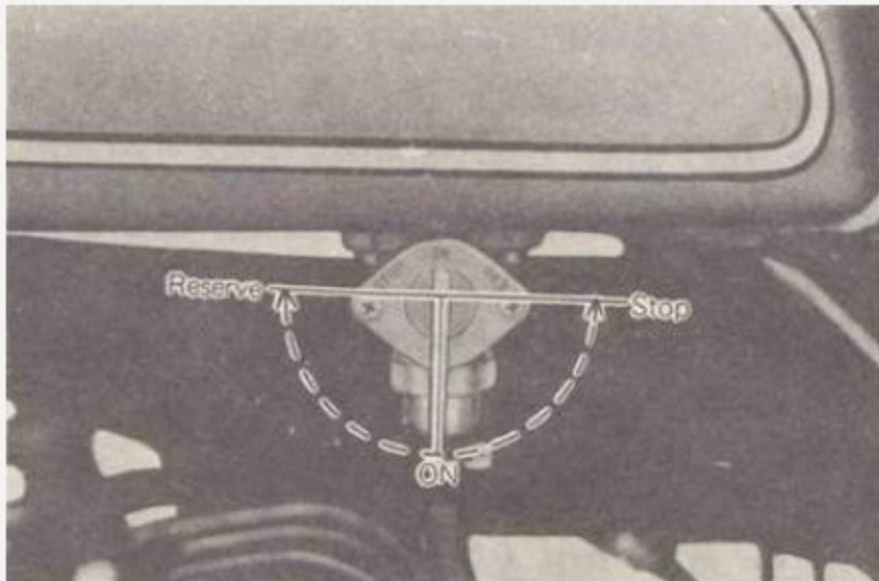
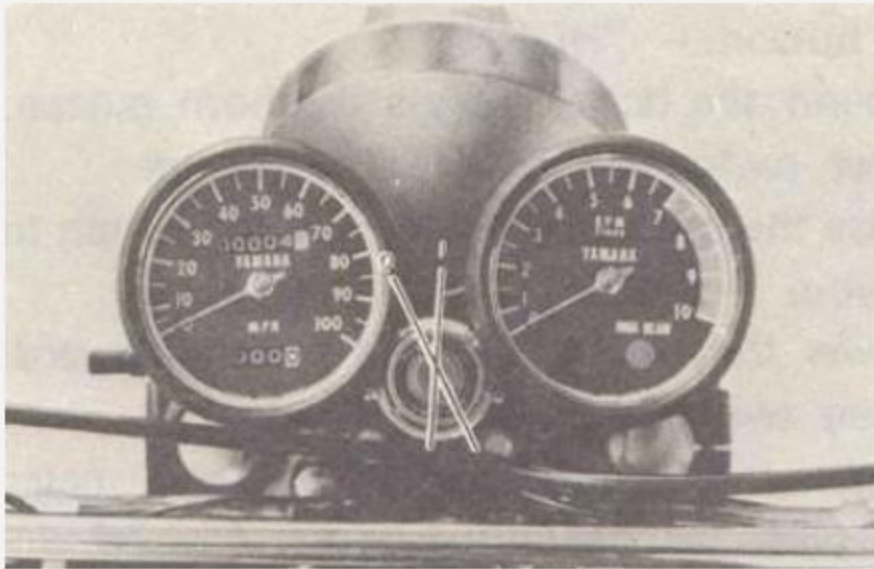

### 1. Main switch

The following chart shows the key position at which the lamps, horn and ignition circuit are switched on or off: (The circle (○) denote "Switch on")

Parts Name	Key position		Instructions
	Off	I	
Ignition Circuit		○	Kick starting
Headlamp		○	Turn on left handlebar switch
Taillamp		○	"
Stoplamp		○	The brake is applied
Meterlamp		○	Turn on left handlebar switch
Horn		○	The horn button is depressed
Flasherlamps		○	Turn on left handlebar switch

### 2. Fuel pet cock

To fill the carburetor float bowls, set the fuel pet cock lever to the OPEN position. If you should run low of fuel on the road, turn the lever to RESERVE position. With just over a quart of fuel, remaining you can drive nearly 25 miles (40 km); enough to get you to the nearest service station for

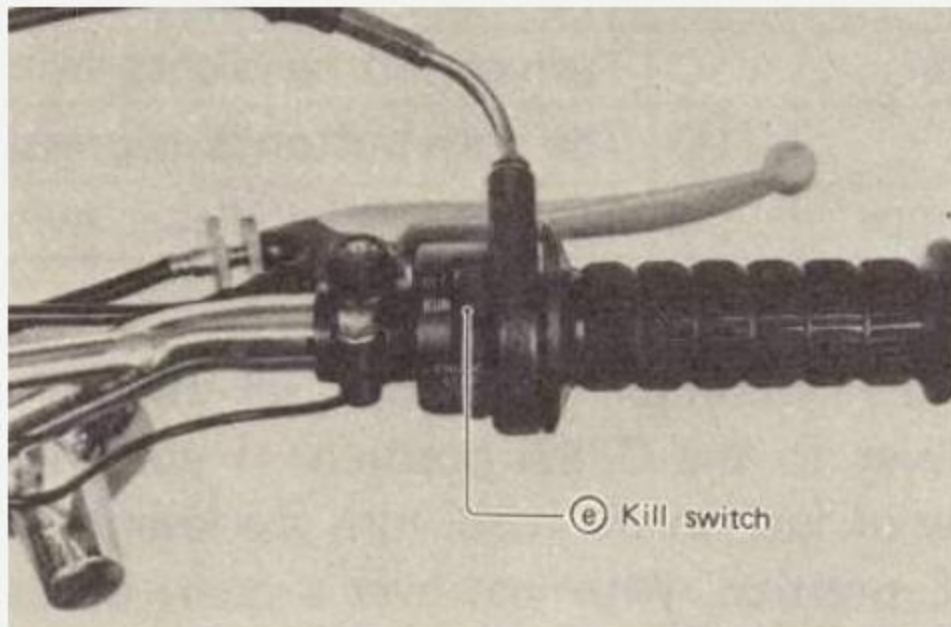
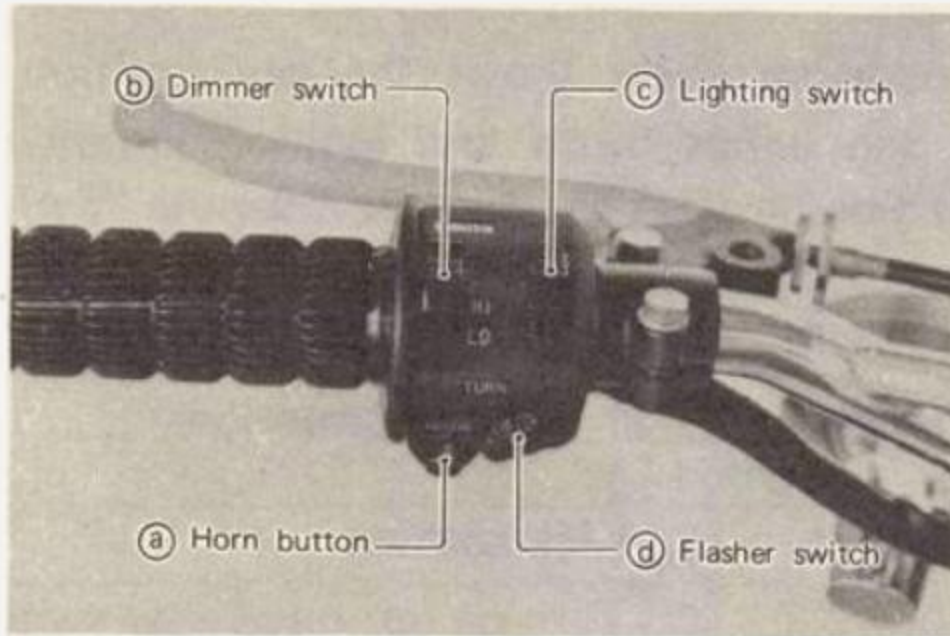

refueling. When parking or storing your machine, be sure that the lever is in the STOP position.

### 3. Handlebar switch & Horn button

#### (a) Horn button – "HORN"

To sound the horn, depress the horn button.

#### (b) Dimmer switch – "LIGHTS" –R–side

To raise the headlamp beam, pull the switch toward you.

To lower the beam, push the switch forward.

#### (c) Lighting switch – "LIGHTS" –L–side

To light the headlamp, taillamp and meter lamps push the headlamp switch forward.

#### (d) Flasher switch – "TURN"

To signal a right turn, push the switch to the right. For left turns, push switch left.

#### (e) Kill switch – "ENGINE STOP"

Make sure that the "Kill" switch is on "RUN". The "Kill" switch has been equipped to ensure safety in an emergency such as when the motorcycle is upset or when trouble takes place on the throttle system.

#### Caution

The engine will not start when the "Kill" switch is turned to "OFF".



#### 4. Indication lamps

- ① High beam indicator – “HIGH BEAM” (BLUE)  
Mounted on the face of the tachometer the high beam indicator glows whenever the head-lamp high beam is in use.
- ② Flasher pilot lamp (ORANGE)  
When flasher switch is on, the pilot lamp flashes.

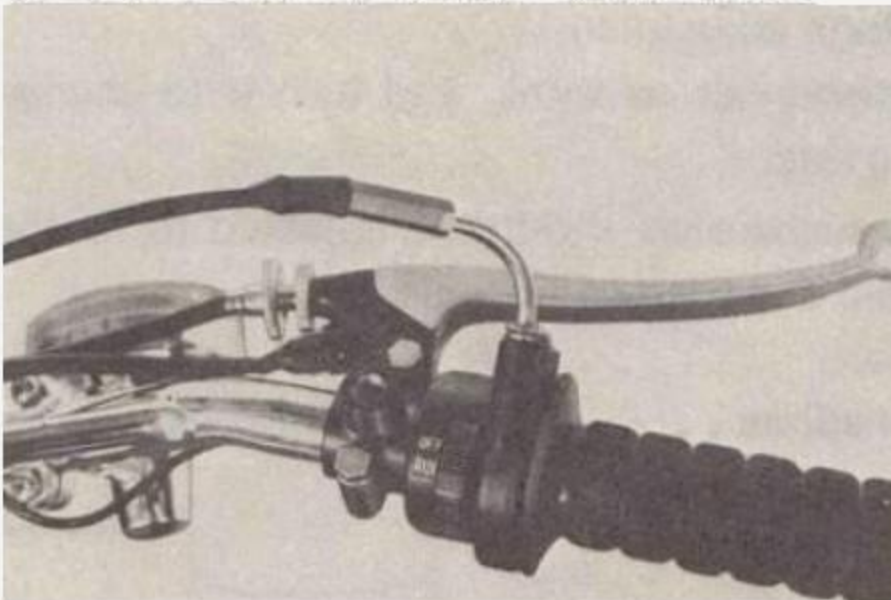

#### 5 Front brake, (Right handlebar lever)

The right handle lever controls the operation of the front brake. The front brake is of the single leading shoe variety and is adjustable at one point, one of which is on the lever. Adjustment will be explained later.

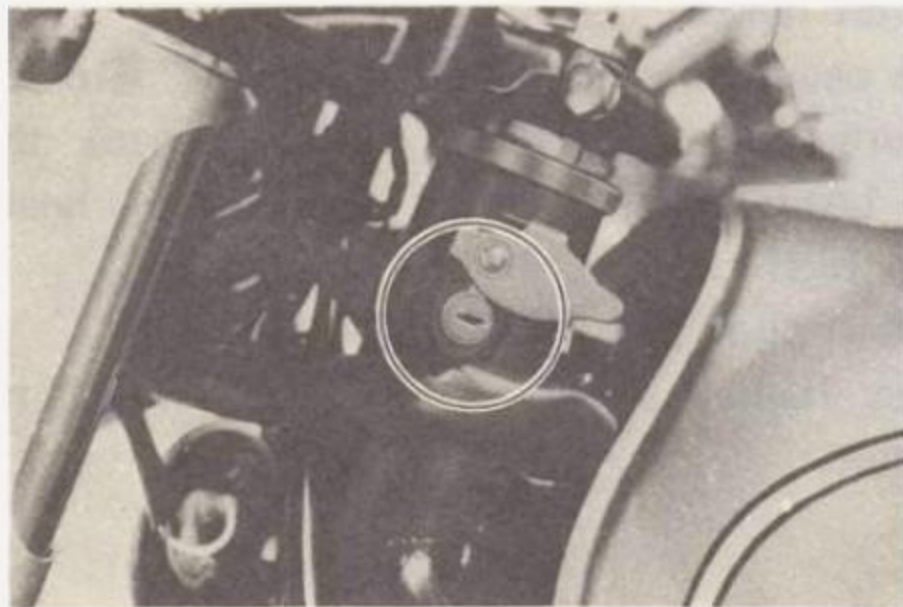

## 6. Steering lock

Turn the handlebar to the right, insert the Ignition key and turn it 45° counter-clockwise then push the key and turn it 45° clockwise. Remove the key after checking to see that the front forks are securely locked. Be sure to lock your forks whenever you park. (see also, #2, Fuel petcock)



## 7. Rear cushion adjustment

Insert screwdriver as show, and turn it to change the spring rate.

The rear suspension should be adjusted to fit the load, speed and road conditions.

Standard . . . . .	A	} (5 positions)
Intermediate . . . . .		
Stiff . . . . .	E	

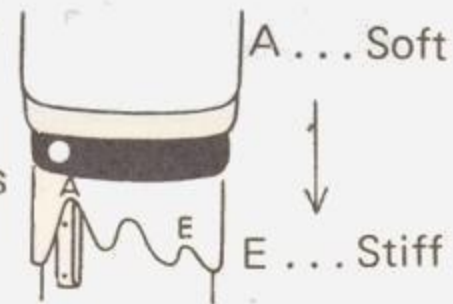

※ Adjust both right & left cushions to the same position



## 8. Tripmeter

A tripmeter is built into the speedometer shell. Twist the knob to reset the tripmeter.

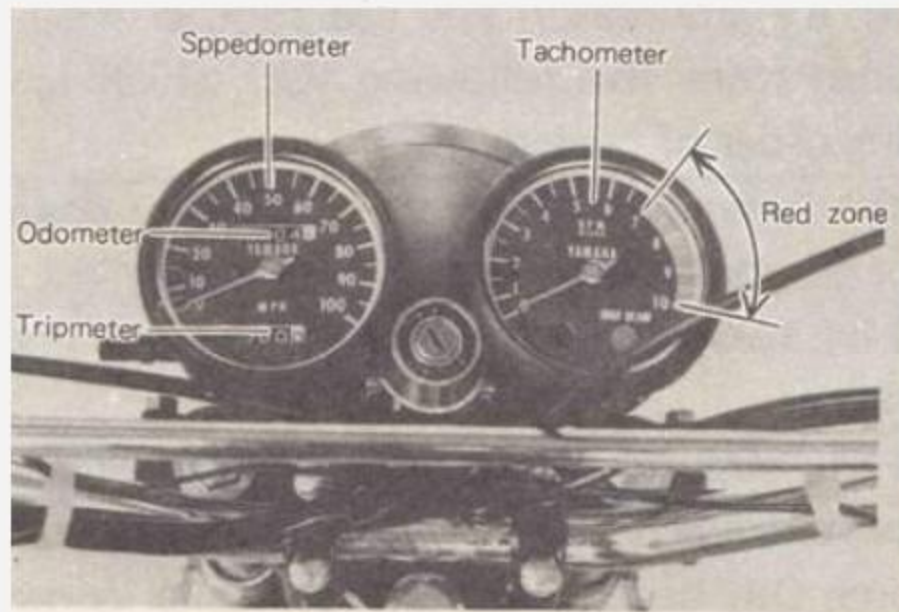

## 9. How to read the tachometer

A tachometer is provided so that the rider can easily maintain engine RPM sufficient to keep the engine within the power curve. For maximum performance accelerate in each gear to 6,000 rpm or at most to 6,500 rpm before shifting. The best range for city driving is 3,500 to 4,000 rpm in lower gears. In this range the engine has ample power and yet is quite docile. Never lug your engine! (i.e. operate below 3,500 r.p.m.) It is recommended not to use red-zone 7,000 - 10,000 rpm.

Caution

See "Break-in" section for additional information.

## Basic Instruction

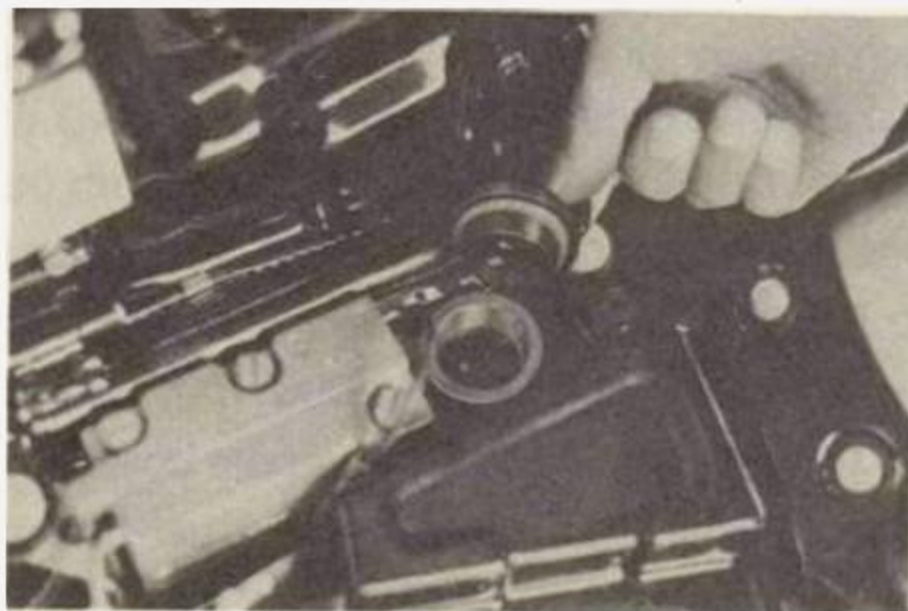
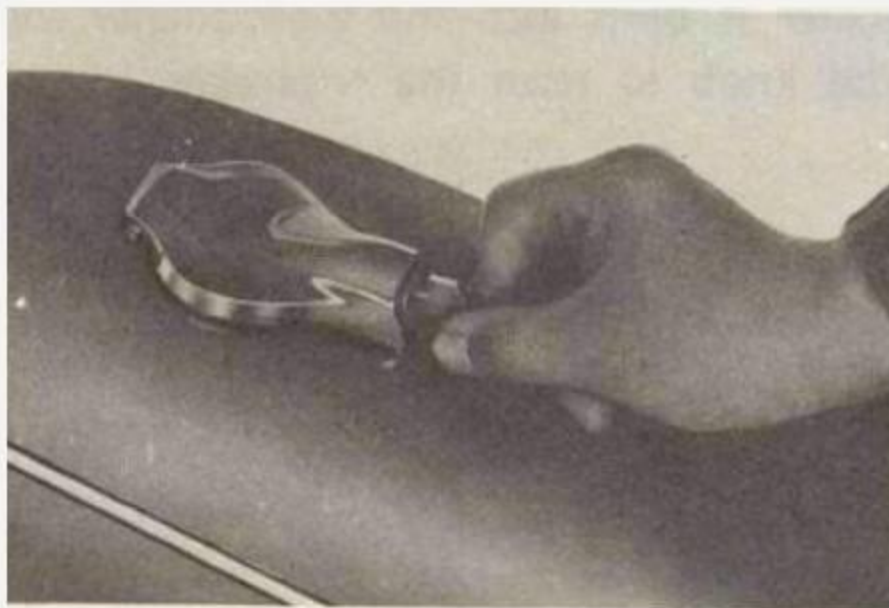

### 1. Gasoline

Use fuel with an octane rating of 90+. Some regular fuels and most mid-range have 90+ octane ratings. Ethyl grade fuels usually have octane ratings in excess of 100. In addition, they have considerable tetra-ethyl lead added which can cause spark plug problems. Whenever possible, use fresh, name brand, gasoline, low lead rating.

### 2. Oil

We recommend that your first choice be YAMA-LUBE, which can be purchased from any Yamaha dealer. If for any reason you use another type of oil, choose from the following list, which is in descending order of preference.

- |  |
|--|
| a. Another brand of 30 wt. two-stroke oil designed for air cooled engines. |
| b. A 30 wt. two-stroke oil designed for water cooled engines.              |
| c. A 30 wt., quality, detergent type automotive oil.                       |

Note: Under extremely cold conditions ( $+32^{\circ}$  and below), Some Oils become exceedingly thick and do not flow as readily.

Consult your dealer regarding the oil you are using and the conditions under which you are riding.



## Operation

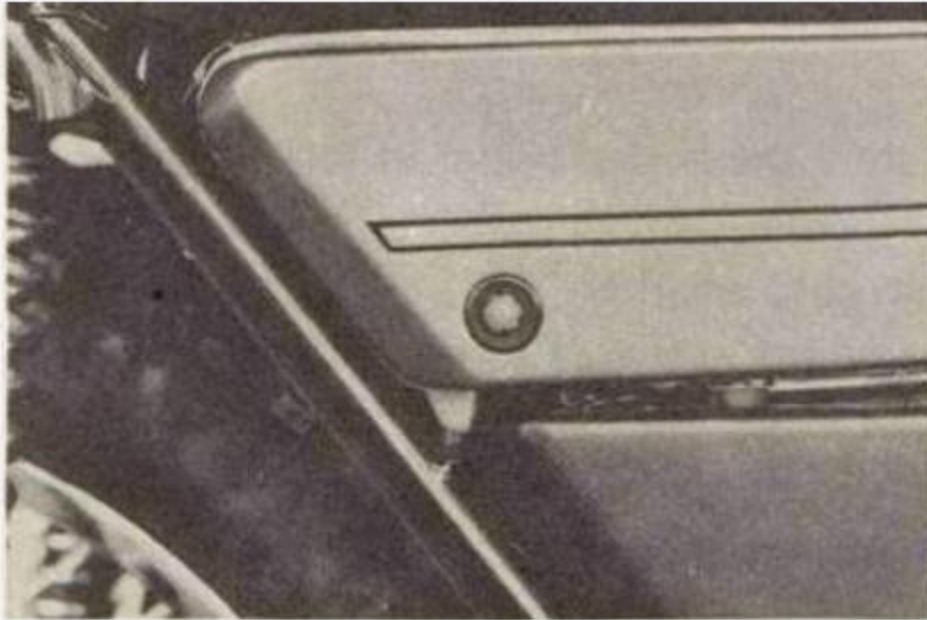

### 1. Before starting

Before you start for a ride you should check several points for safety. In particular:

a Do you have enough fuel?

b Do you have enough oil?

If the oil is below the level mark in the glass port, add oil. Make sure that the oil is sufficient for your driving plan by using an oil level gauge. (Refer to basic instruction for type of oil)

### c Are your tire pressures correct?

Incorrect tire pressures affect the comfort, handling, acceleration and life of tires. Incorrect tire pressures can also lead to accidents!

	Front tire	Rear tire
Normal riding	13 lbs/in <sup>2</sup> (0.9 kg/cm <sup>2</sup> )	16 lbs/in <sup>2</sup> (1.1 kg/cm <sup>2</sup> )

### d Do both brakes and the stoplamp work?

### e. Are the lights and horn working?

Check the headlamp, taillamp, meterlamps, and indicating lamps. The few minutes you save by not checking are not worth being stranded without lights!

## 2. Starting

- a Turn the fuel pet cock lever to the "OPEN" position.
- b Insert the ignition Key and turn it to the #1 position

The use of a primary kick starting system enables you to start the engine either in gear or in neutral (if in gear, pull in the clutch lever)

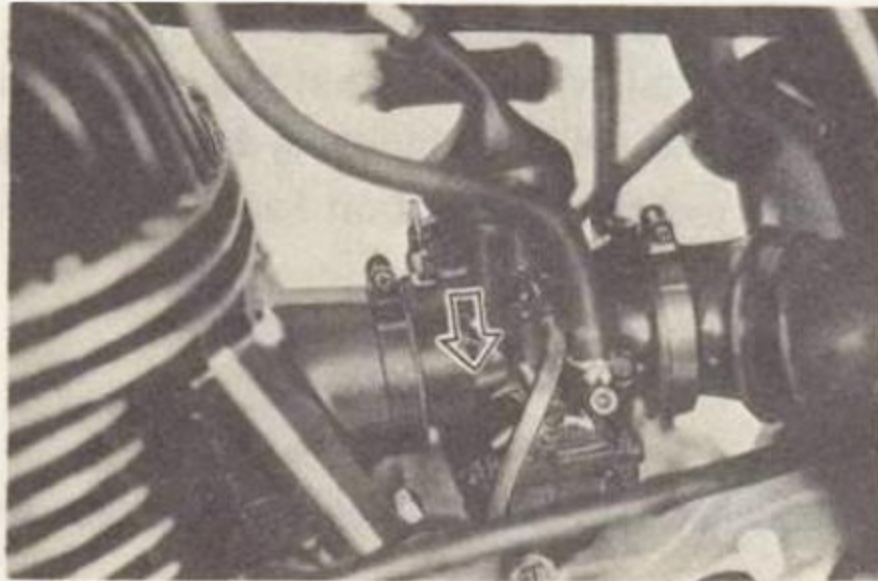

### A Starting in cold weather

Most engine are difficult to start in cold or freezing weather.

YAMAHA Motorcycles however, uses a carburetor with a built in starter jet that gives a richer mixture for easier cold weather starting.

- a Depress the starter lever.
- b Start the engine with the kick starter, keeping the throttle closed.

### B Starting when your engine is warm

When your engine is warm, after riding or in warm weather, don't use the starter lever. Open the throttle slightly ( $\frac{1}{4}$  turns or less) and kick the starter.

### C Warming up

To get maximum engine life, always "warm up" the engine for a few minutes before starting off. Never accelerate hard with a cold engine! To see whether or not the engine is warm, see if it responds to throttle normally. Don't forget to raise the starter lever after the engine is warm.

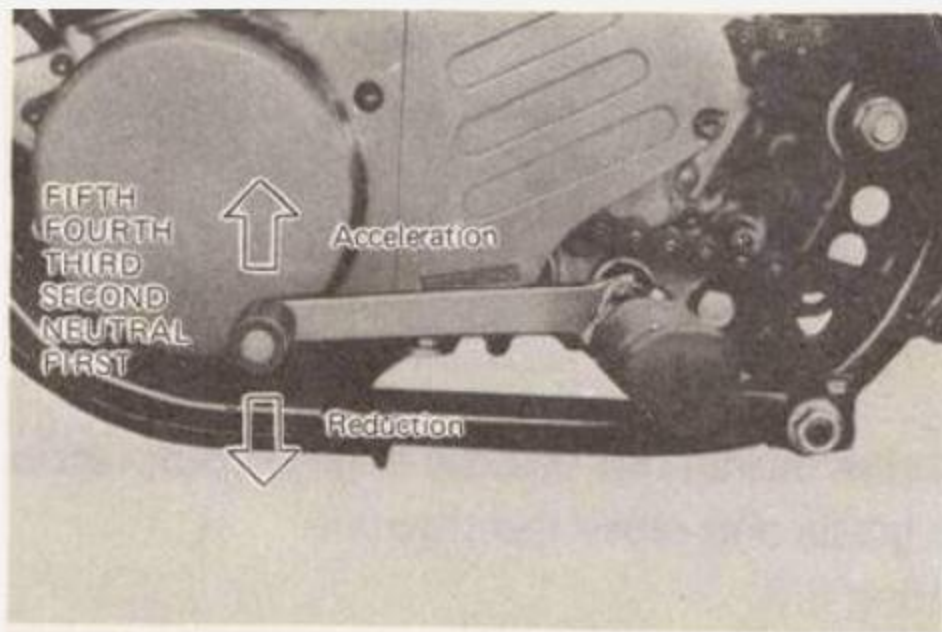

### 3. Shifting and Acceleration

DT250 has a 5-speed transmission. The transmission allows you to control the amount of power you have available at a given speed for starting, accelerating, climbing hills, etc.

The use of the change pedal is illustrated at the left.

To shift into NEUTRAL, depress the change pedal to the end of its travel (you will feel a stop when you are in low gear), then raise it slightly.

- a. Pull the clutch lever to engage the clutch.
- b. Shift into FIRST gear.
- c. Open the throttle gradually, and, at the same time, release the clutch lever slowly.
- d. At 10 to 15 mph, close the throttle, and at the same time pull in the clutch lever quickly.
- e. Shift into SECOND gear. Be careful not to shift into neutral.
- f. Open the throttle part way and gradually release the clutch lever.
- g. To accelerate or decelerate, use the same procedure to shift into THIRD, FOURTH, and FIFTH gears.
- h. Except for competition or high speed driving, shift so that the engine speed remains between 4,000 ~ 5,000 rpm. This is the optimum operating range for the engine.

**a Going Uphill**

When starting to climb a gentle grade, open the throttle little by little to avoid losing engine speed and power.

When climbing a steep grade, shift down from THIRD to SECOND or from SECOND to FIRST as required.

**b Going Downhill**

On a long down grade or sharp descent, don't rely on the brakes alone, but use the engine compression as a brake: shift into THIRD or SECOND as required by the grade and close the throttle.

**CAUTION:** Never attempt to turn off the ignition switch on a long hill.

This may cause the spark plug to foul, in addition to being unsafe.

**4. Off-road Riding**

When you ride your motorcycle over rough land, safety parts may break or fall off due to shocks from the ground or due to accidents such as falling, and breakage or loss of parts may result. It is advisable to remove all safety parts before you start riding.

Parts to be removed : Headlamp, taillamp, speedometer, tachometer, and side stand.

**Caution on Riding over Paved Roads at High Speeds :**

The DT250 is equipped with tires having a block pattern. As a result, the area where the tire contacts the ground is smaller compared with other types of tires. Therefore, take care to avoid slipping your motorcycle when you are cornering at high speeds and at sharp angles.

## 5. Stopping

There are several ways to stop.

Pulling in the clutch lever and twisting the throttle grip in the closed direction will permit you to gradually glide to a stop. Downshifting through the gears, using the drag of the engine to slow down is another. However, the best method, and the one most universally used, is to use both engine compression (downshifting through the gears as the machine slows) and the front and rear brakes.

When stopping, gradually apply the rear brake while twisting the throttle grip in the closed direction. After the rear brake starts to take hold, gradually apply the front brake.

As the machine continues to slow shift down through the gears using engine compression to aid the slowing effect. When shifting down, watch the tachometer to see that the engine does not over-revolution.

**Note:** During periods of Inclement weather, snow, rain, sleet, or ice, or on poor road surfaces where traction is minimal, or in a sharp corner, IT IS NOT ADVISABLE TO FIRMLY APPLY THE FRONT BRAKE. While it is true that the front brake supplies the greater portion of braking power, it is also true that stability can be upset very easily if it is used incautiously under the above conditions.

## 6. Cruising

A frequently asked question is "What rpm should I cruise at?"

The BREAK-IN section provides limitations when the motorcycle is new, but once the engine has been broken in, then we suggest that you follow these guide lines. For sustained load and throttle conditions, such as those encountered on open highways, cruise at  $\frac{3}{4}$  throttle or at  $\frac{3}{4}$  of the rpm "red line", whichever comes first. Always bear in mind though, the maximum allowable speed limit for the area through which you are riding. This is a recommendation, not a "hard and fast" rule. Any modification or personalization of the running gear could possibly change the operating range most comfortable and most

efficient for the engine.

## 7. Break-in

THERE IS NEVER A MORE IMPORTANT PERIOD, IN THE LIFE OF YOUR DT250 THAN THE PERIOD BETWEEN ZERO AND FIVE HUNDRED MILES. For this reason we ask that you carefully read the following material.

Because the engine is brand new, you must not put an excessive load on it during the first several hours of running. You could look at it in this manner: During the first 100 miles the various parts in the engine wear and polish themselves to the correct operating clearances. During this period prolonged full throttle operation, or any condition which might result in excessive head and cylinder temperatures, must be avoided. However, momentary full throttle operation, under load, (2-3 seconds maximum) does not harm the engine. Each full throttle acceleration sequence should be followed with a substantial rest period for the engine by cruising at lower rpm's so the engine can rid itself of the temporary build up of heat. The method for breaking in DT250 is quite simple. (See following page.)

## Break-in (Continued)

- a 0 to 100 miles:            Avoid operation above 4,000 rpm.  
Allow a cooling off period of 5 to 10 minutes after every hour of operation.  
Vary the speed of the motorcycle from time to time. Do not operate it at one, set, throttle position.
  
- b 100 to 250 miles:        Avoid prolonged operation above 5,000 rpm.  
Allow the motorcycle to rev freely through the gears but do not use full throttle at any time.
  
- c 250 to 500 miles:        Avoid prolonged full throttle operation.  
Avoid cruising speeds in excess of 6,000 rpm.
  
- d 500 miles and beyond:    Avoid prolonged full throttle operation.  
Avoid engine speeds in excess of 7,000 rpm. Vary speeds occasionally.

Note: See lubrication and Maintenance charts for initial 300, 1000, and 2000 mile service.

## Service Tools

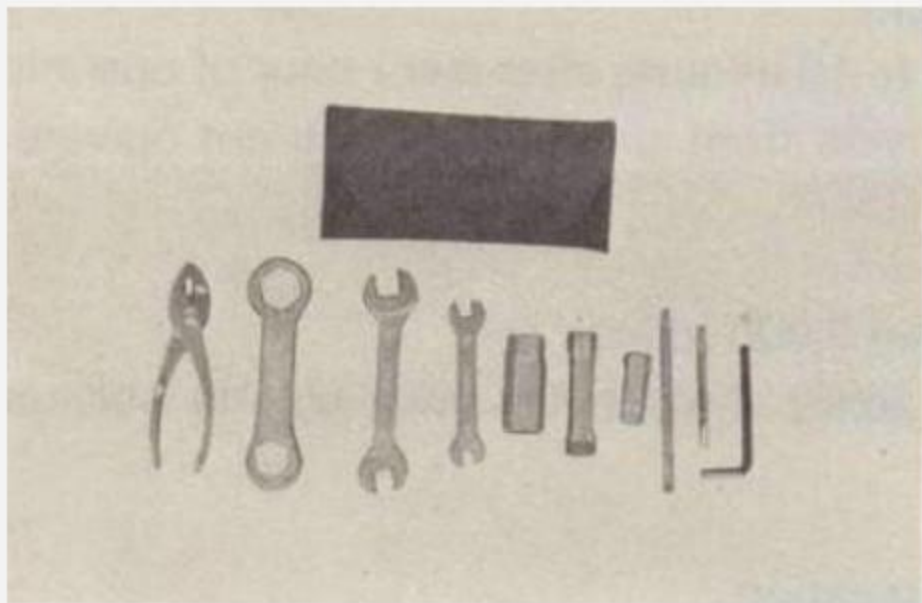

The servicing information included in this manual is intended to provide you, the owner, with the necessary information to provide a means of doing your own preventive maintenance and minor repairs.

The tools provided in the owner's tool kit are sufficient for this purpose, except that a torque wrench is also necessary to properly tighten nuts and bolts.

(See torque chart, P.26)

Should you desire additional service information on your DT250 a copy of Service Manual can be purchased from any Authorized YAMAHA Dealer or direct from the Literature Department, Yamaha International Corp., P.O. Box 6600, Buena Park, Calif. (90620).

(Canadian Distributor: Fred Deely Ltd., 854 West 6th, Vancouver B.C., Canada)

## Lubrication and Maintenance Chart

These charts should be considered strictly as a guide to general lubrication and maintenance periods. You must take into consideration that weather, terrain, geographical locations, and a variety of individual uses all tend to demand that each owner alter this time schedule to match his environment. For example, if the motorcycle is continually operated in an area of high humidity, then all parts must be lubricated much more frequently than shown on the chart to avoid the ravages of water on metal parts. If you are in doubt as to how closely you can follow these time recommendations, check with the YAMAHA dealer in your area.



### Lubrication Intervals

	Item	Type	Initial			Thereafter Every	
			300 miles	1,000 miles	2,000 miles	2,000 miles	4,000 miles
1	Brake cam shaft	G		○	○	○	
2	Wheel bearing	G			○		○
3	Brake cable	M/O		○	○	○	
4	Clutch cable	M/O		○	○	○	
5	Tacho, speedometer cable	G			○	○	
6	Meter gear unit	G			○	○	
7	Steering ball race	G					○
8	Front fork oil	M/O	○		○	○	
9	Brake pedal shaft	G		○	○	○	
10	Change pedal shaft	M/O,G			○	○	
11	Accelerator grip	G		○	○	○	
12	Transmission oil	M/O	○	○	○	○	
13	Dynamo lubricator	G					○
14	Stand shaft	M/O,G					○
15	Rear arm pivot shaft	G			○	○	
16	Drive chain	M/O		○	○	○	

※ G . . . . . Grease

※ M/O . . . . . Motor Oil

## Periodic Maintenance Intervals

	Item	Preoperation check	Initial			Thereafter Every	
			300 miles	1,000 miles	2,000 miles	2,000 miles	4,000 miles
1	Front and rear brake adjustment (F.R)	<input type="radio"/>	<input type="radio"/>	<input type="radio"/>	<input type="radio"/>	<input type="radio"/>	
2	Clutch adjustment	<input type="radio"/>	<input type="radio"/>	<input type="radio"/>	<input type="radio"/>	<input type="radio"/>	
3	Transmission oil replacement		<input type="radio"/>	<input type="radio"/>	<input type="radio"/>	<input type="radio"/>	
4	Front fork oil replacement		<input type="radio"/>		<input type="radio"/>	<input type="radio"/>	
5	Grease up			<input type="radio"/>	<input type="radio"/>	<input type="radio"/>	
6	Battery electrolyte refilling	<input type="radio"/>	<input type="radio"/>	<input type="radio"/>	<input type="radio"/>	<input type="radio"/>	
7	Spark plug cleaning		<input type="radio"/>	<input type="radio"/>	<input type="radio"/>	<input type="radio"/>	
8	Ignition timing adjustment		<input type="radio"/>	<input type="radio"/>	<input type="radio"/>	<input type="radio"/>	
9	Fuel pet cock cleaning		<input type="radio"/>	<input type="radio"/>	<input type="radio"/>	<input type="radio"/>	
10	Carburetor adjustment			<input type="radio"/>	<input type="radio"/>	<input type="radio"/>	
11	Carburetor cleaning						<input type="radio"/>
12	Air cleaner cleaning			<input type="radio"/>	<input type="radio"/>	<input type="radio"/>	
13	Cylinder, piston cleaning			<input type="radio"/>		<input type="radio"/>	
14	Silencer muffler cleaning			<input type="radio"/>		<input type="radio"/>	
15	Drive chain adjustment, oiling		<input type="radio"/>	<input type="radio"/>	<input type="radio"/>	<input type="radio"/>	
16	Autolube pump adjustment		<input type="radio"/>	<input type="radio"/>	<input type="radio"/>	<input type="radio"/>	
17	F.R.wheel inspection	<input type="radio"/>	<input type="radio"/>	<input type="radio"/>	<input type="radio"/>	<input type="radio"/>	
18	Bolt, Nut retightening	<input type="radio"/>	<input type="radio"/>	<input type="radio"/>	<input type="radio"/>	<input type="radio"/>	
19	Spoke, Rim inspection		<input type="radio"/>	<input type="radio"/>	<input type="radio"/>	<input type="radio"/>	

Be sure to check the above points before long-distance touring.

## Lubrication recommendation

Transmission oil	Use a 10w/30 multi-viscosity oil, or a quality 30wt oil. (SAE "SE")
Swing arm shaft grease Brake actuating cam grease. Steering head bearing grease. Rear brake pivot point grease. Throttle grip grease.	Use an all purpose, chassis-type grease that does not break down easily in water (Shell and Lubriplate, as examples, carry this grease).
Front fork oil.	Use 10w/30, 20wt, or 30wt oil for street, use 30 or 40wt oil for dirt (nonfoaming, if possible).
Autolube oil.	See BASIC INSTRUCTION section.

### A Note To The Owner

Periodic Maintenance and Lubrication Interval charts are included within this manual to provide you with the necessary information for appropriate preventive maintenance. If any procedure in the charts is not completely understood, or not covered in this manual, please consult your Authorized Yamaha Dealer for the necessary service.

In some instances, failure to have the machine properly serviced by your dealer will void the Warranty on your machine. Therefore, it is most important to study the charts, this manual, and your Warranty obligations most carefully.

**SERVICE DEPARTMENT**

## Torque

All fittings require a minimal amount of torque during tightening to keep them from vibrating loose. Excessive tightening will only lead to stripped threads and broken studs.

As a rule of thumb, use the following tightening chart:

STUD SIZE	TORQUE
6 mm	90 in/lbs.
7 mm	135 in/lbs.
8 mm	180 in/lbs.
10 mm	300 - 350 in/lbs.
12 mm	350 - 400 in/lbs.
14 mm	400 - 450 in/lbs.
Axle Nuts	500 - 600 in/lbs.
Spark Plugs	130 - 170 in/lbs.

## Servicing

### 1. Clutch cable

The clutch cable requires periodic lubrication to prevent the cable strands from rusting or hanging up in the casing. First, disconnect the cable from the clutch lever by screwing the adjuster all the way back to the cable casing. This will provide enough free play, in the cable for you to slip the cable out of the lever holder through the slot in the lock nut, adjuster, and holder. Hold the cable upright and allow several drops of lubricant to flow down the cable. Hold the cable upright for several minutes to permit complete lubrication.

If the cable needs to be replaced, then perform the steps above and disconnect the cable at the lever. Next, disconnect the cable at the engine. Begin by taking off the cover that houses the clutch activating mechanism (left side of the engine). Looking at the inside of this cover, you will see the clutch actuating arm. Push the arm up and lift the cable end off. Removing the old cable and hooking up the new one will take but a few moments.

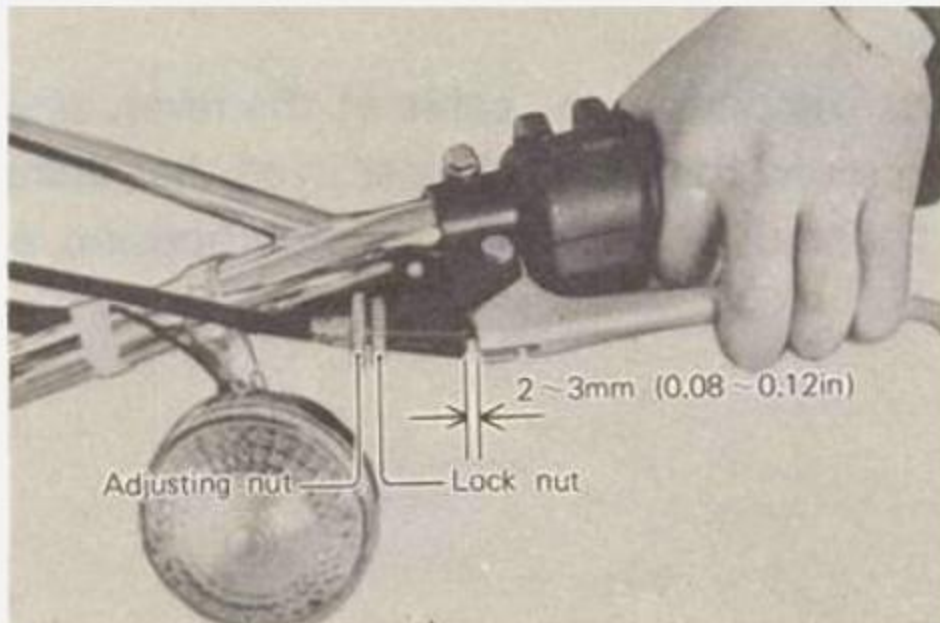

### 2. Clutch adjustment

The DT250 has two clutch adjustments. The first adjustment, located at the handlebar lever, is used to take up slack from cable stretch and to provide sufficient free play so that the clutch engages and disengages completely. The picture left illustrates all the parts involved in making the adjustment.

- a First, loosen the lock nut. Then turn the adjuster either in or out depending on which direction is necessary to arrive at 1/16"–1/8" (2-3mm) free play.

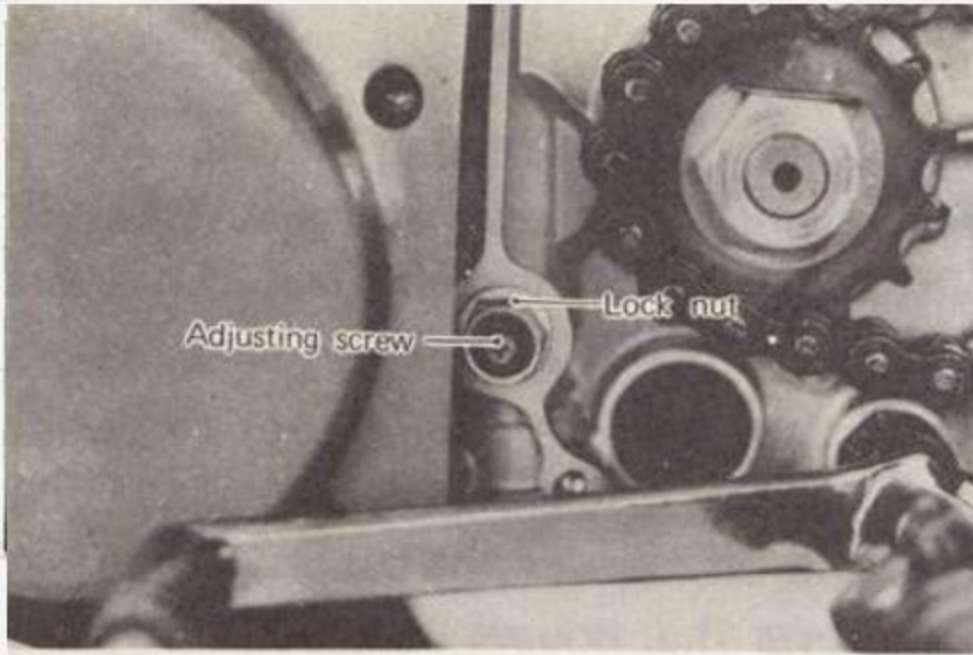

- b The second adjustment is located behind the crankcase cover (L). Removing the cover will expose the adjusting set screw and lock nut. Loosen the lock nut, rotate the set screw in until it lightly seats against a clutch push rod that works with the set screw to operate the clutch. Back the set screw out  $\frac{1}{4}$  turn and tighten the lock nut. This adjustment must be checked because heat and clutch wear will affect this free play, possibly enough to cause incomplete clutch operation.

### 3. Brake cable

This cable also needs periodic lubrication. To release one end of the cable for lubrication, follow the same procedures as listed previously in the clutch cable section.

Removal of the front brake cable requires that you must first disconnect the cable at the lever, as was just explained. To disconnect it at the front hub, you have to screw the cable adjuster in so that there is plenty of cable slack right at the brake. Line up the slots in the adjuster lock nut, and hub housing, and slip the cable out of the adjuster and out through the slots.

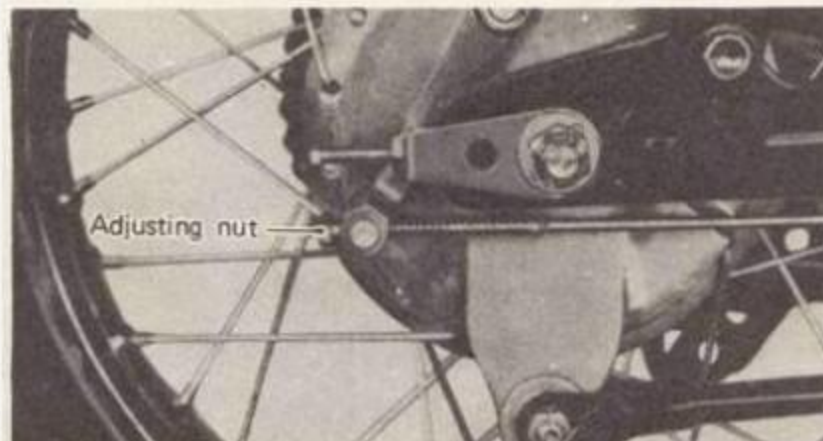
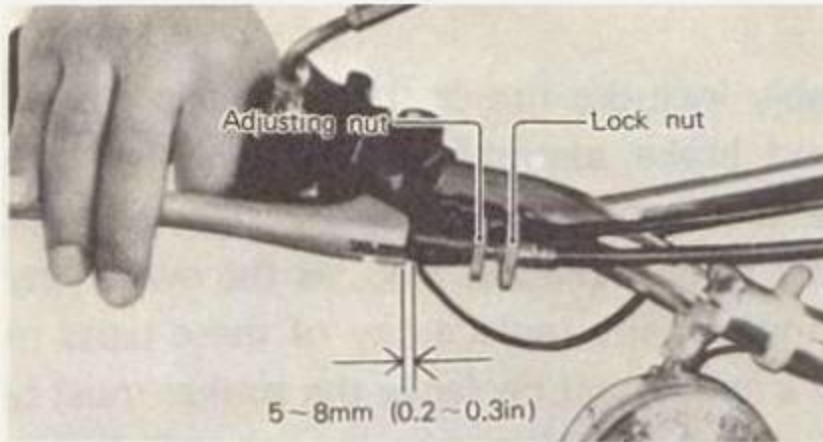

#### 4. Front brake adjustment

It is much easier to make it at the brake lever. This is done by loosening the lock nut, and screwing the adjuster in or out until you have 0.2-0.3 in. (5-8mm) free play.

#### 5. Rear brake adjustment

The correct free play of the rear brake pedal is about 1.0 in. (25 mm.). Adjust by turning the adjusting nut at the end of the rear brake rod a half turn at a time. After adjusting the brake, make sure the brake light is working. If not, readjust the stoplight switch.

**Note:** Inspect the brake linings for wear and clean the brake shoes and drums every 2,000 miles (3,000 km). Always keep the shoes and drums free of oil.

Rear brake adjustment should be performed any time the wheel is moved or removed.

## 6. Front wheel

Work that might need to be done on the front wheel assembly includes tire or tube exchange, brake shoe replacement, hub/spokes/rim assembly replacement, and brake assembly maintenance and inspection. The following are the steps necessary to dismantle the front wheel, step by step, and you should proceed with the steps until you have removed the part to be replaced. You, as the owner, can replace everything but the hub, the spokes, or the rim. To individually replace any of these parts requires that the spokes be "replaced". This should be done by a competent dealer as the spokes must be positioned and torqued correctly. If not done properly wheel alignment will not be correct and steering will be negatively affected.

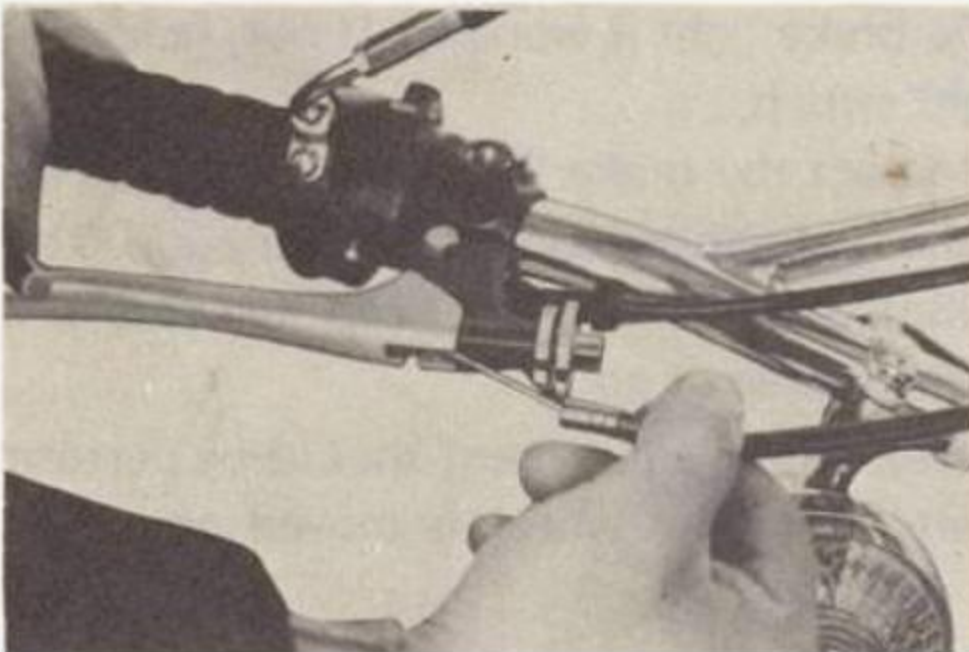

## 7. Front wheel removal

To carry out front wheel repair, you must remove the wheel.

- a Disconnect the brake cable at the front brake lever.



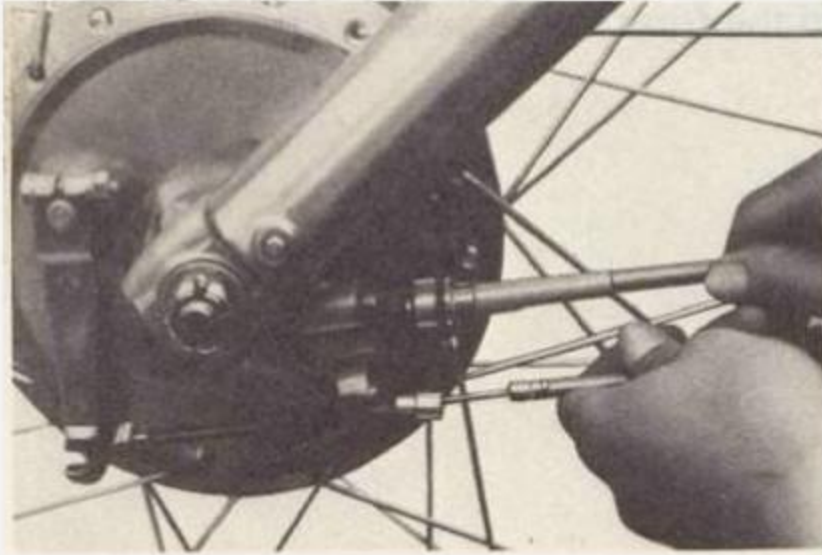

- b Disconnect both the brake cable and speedometer cable from the front wheel hub plate.

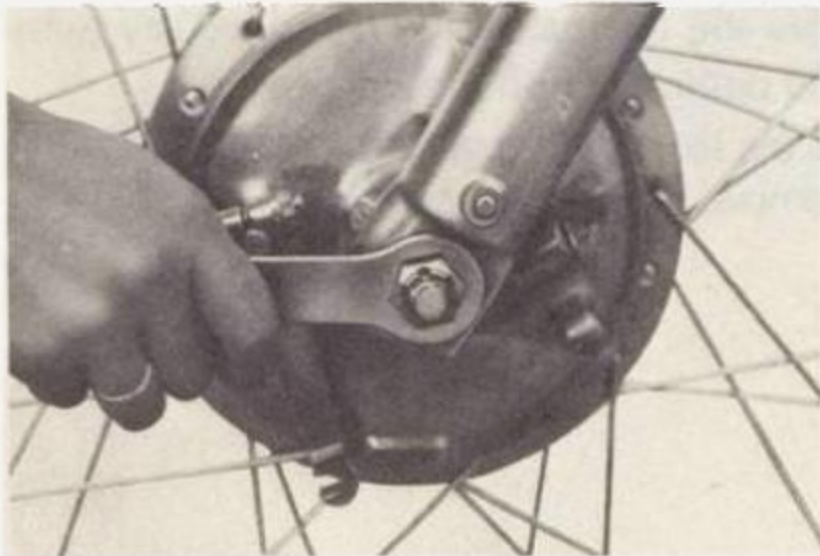

- c Remove the cotter pin and front wheel nut.

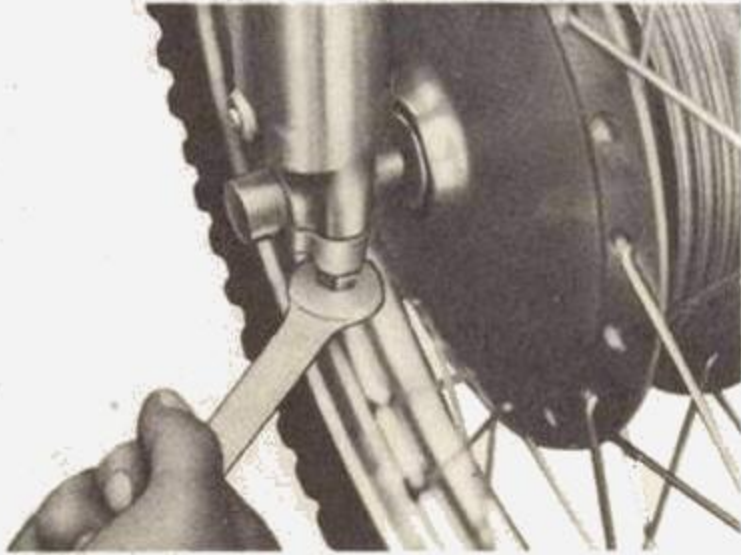

d Loosen the front wheel axle pinch bolts.



e Remove the front axle by simultaneously twisting and pulling out on the axle.

f Brace the front of the machine off the ground and remove the wheel assembly.

The brake plate can now be easily slipped out of the front wheel hub. The brake plate carries both brake shoes. They can be left in place on the brake plate for measurement, as shown below, or they can be lifted off for replacement or maintenance. The two brake shoes are held in place by two springs. These springs hold the two shoes to the brake actuating cams. Removal of these springs, or spreading them, will allow the shoes to be lifted off. Whenever you have the brake plate off the wheel assembly, it is very good policy to apply a small amount of grease to the brake actuating cams.

Shown immediately below are two steps that must be performed periodically to maintain maximum stopping efficiency. The brake linings and brake drum must be in correct working condition, and these steps do much to guarantee perfect working order.

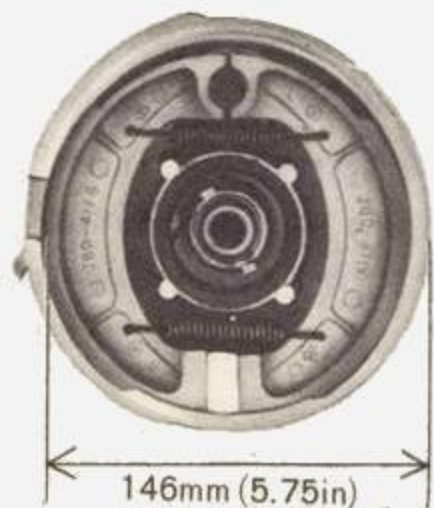

#### 9 Brake shoe

Measure the outside diameter of the brake shoe set with slide calipers.

If it measures less than 5.75 in. (146mm), replace it. Smooth out any rough shoe surface with sandpaper or with a file.



## 9. Brake drum, Rimspeaks, Front and rear wheels.

Oil or scratches on the inner surface of the brake drum will impair braking performance or result in abnormal noises. Remove oil by wiping with a rag soaked in lacquer thinner or solvent. Remove scratches by lightly and evenly rubbing with emery cloth.

There are also checks that you can perform to determine if wheel work is necessary for your dealer to do. First, check for any loose spokes. This can be checked by bracing the front end off the ground so that the front wheel can spin free. Slowly revolve the front wheel and at the same time let the metal shaft of a fairly heavy screwdriver bounce off each spoke. If all the spokes are tightened approximately the same, then the sound given off by the screwdriver hitting the spokes should sound the same. If one spoke makes a dull flat sound, then check it for looseness.

While you have the front end up in the air, you should check that the front wheel does not have too much run-out. "Run-out" is the amount the front wheel deviates from a straight line as it spins.

Secure the front forks to keep them from turning, spin the front wheel, and solidly anchor some sort of a pointer about 1/8" away from the side of the rim.

As the wheel spins, the distance between the pointer and the rim should not change more than 1/16" total. Any greater fluctuation means that you should have your dealer remove this rim warpage by properly adjusting the spokes.

## 10. Rear wheel

A complete list of rear wheel parts that you can remove, certain precautions and limitations that must be adhered to, checking for wheel run-out, and checking for spoke tightness can all be found in the FRONT WHEEL section. In order for you to carry out those steps that are possible, a list of procedures is given explaining how to completely disassemble the rear wheel assembly.



## 11. Rear wheel removal

- a Remove the tension bar and the brake rod from the rear shoe plate. Presence and location of the lock washer and cotter pin. These are safety parts and must be included during reassembly.
- b Loosen the chain tension adjusting nuts and bolts on both right and left sides.

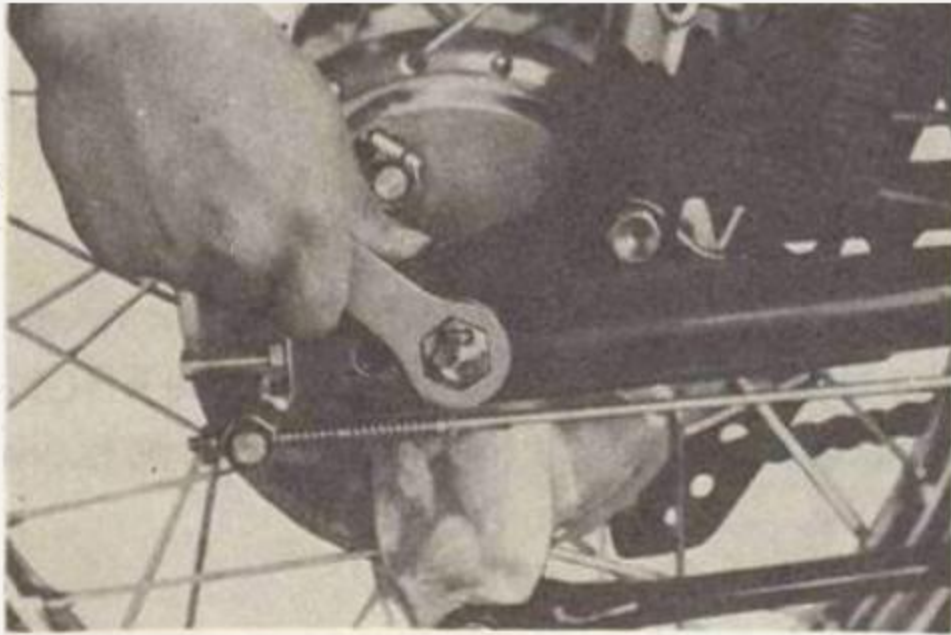

- c Disconnect the drive chain.
- d Remove the cotter pin and rear wheel shaft nut.
- e Remove the right hand chain adjuster and distance collar.

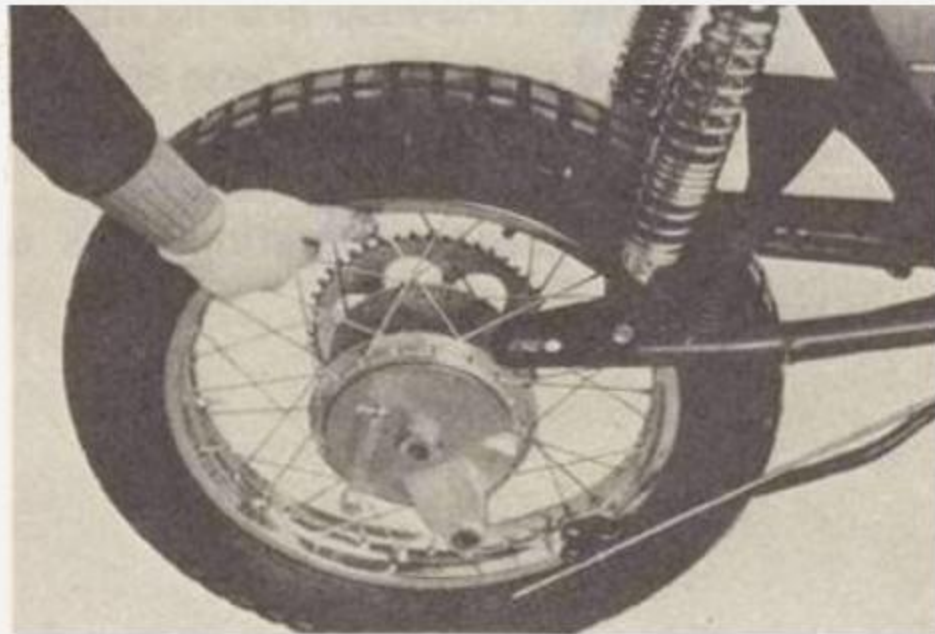

- f Remove the chain adjusters distance collar and pull back the wheel ass'y.  
When reconnecting the chain, be sure the master link is facing in the correct direction.

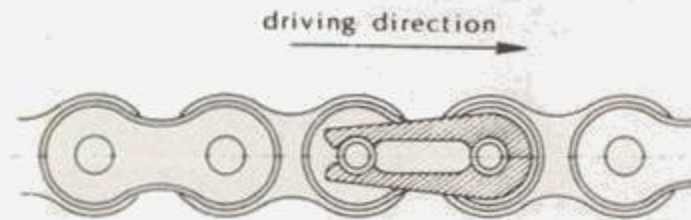

After reconnecting the chain adjust the free play to 3/4 in. (20mm) up and down, at the center of the lower section with the rear wheel on the ground.

## 12. Tire repair

First, remove the valve cap and valve stem lock nut. Empty all the air out of the tire. Use two tire removal irons (with rounded edges) and begin to work the tire bead over the edge of the rim, starting 180° opposite the tube stem. Take care to avoid pinching the tube as you do this. After you have worked one side of the tire completely off the rim, then you can slip the tube out. Be very careful not to damage the stem while pushing it back out to the rim hole. If you are changing the tire itself, then finish the removal by working the tire off the same rim edge just previously mentioned.

Reinstalling the tire assembly can be accomplished by reversing the disassembly procedure. The only difference in procedure would be right after the tube has been installed, but before the tire has been completely slipped onto the rim, inflate the tube. This removes any creases that might exist. Release the air continue with reassembly. Also, right after the tire has been completely slipped onto the rim, check to make sure that the stem is squarely in the center of the hole in the rim.

Inflate the tire to specified pressure

Front	13 lbs/in <sup>2</sup> (0.9 kg/cm <sup>2</sup> )	For off-road
Rear	16 lbs/in <sup>2</sup> (1.1 kg/cm <sup>2</sup> )	

### 13. Rear wheel sprocket

This sprocket is an integral part of the motorcycle's overall gearing. Because of this it receives a certain amount of punishment. Eventually it might wear enough to need replacement. Or, perhaps a different sized sprocket might be desired to change the overall gearing. (A larger sprocket cuts down the top speed but provides the motorcycle with more pulling power.) Whichever reason it might be, the end result would be the necessity of removing the rear wheel sprocket. After removing the entire wheel assembly from the frame, proceed with the steps listed below.

**Note:** Check with your dealer to determine what would be the correct size sprocket to install. Tell him where you plan to ride it, how much weight will be carried, and how closely the current gearing comes to satisfying you now.



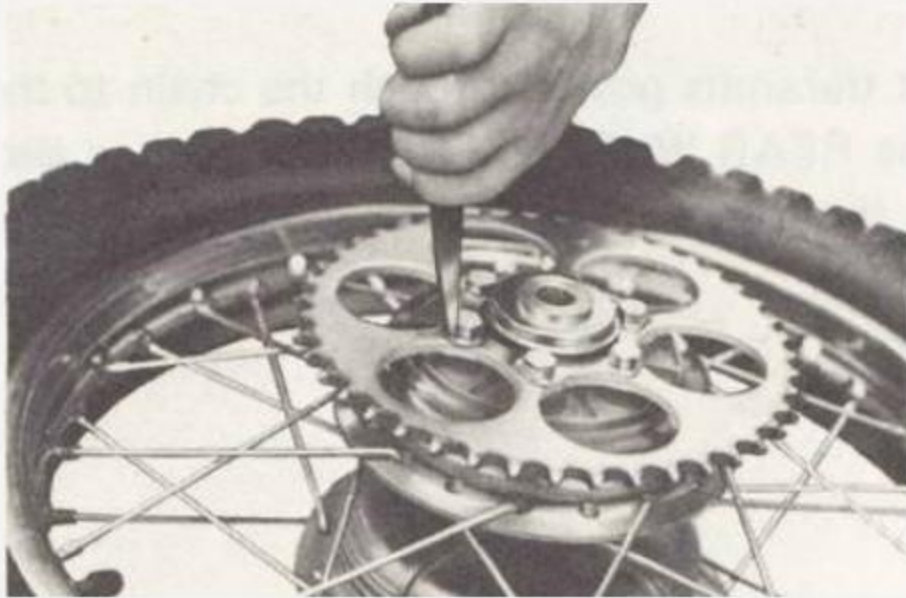

### Sprocket wheel removal

- a Remove the rear wheel.
- b Bend the lock washer ears flat.

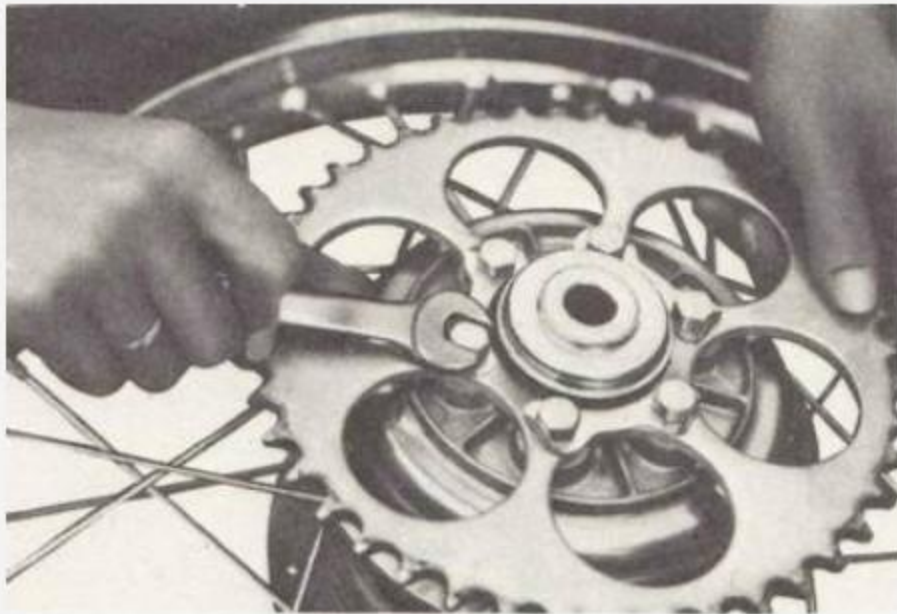

- c Remove the sprocket mounting bolts. Check the lock washer and hexagonal bolt for breakage and damage. If the lock washer is not bent over the hexagon bolt head, or is broken, or the bolt is loose, the sprocket can come loose. Make sure that both lock washers and the mounting bolts are tight.

#### 14. Countershaft sprocket

This sprocket is bolted to the back transmission shaft and it transmits power through the chain to the Drive sprocket. All that was mentioned just previously in the REAR WHEEL SPROCKET section also applies to this sprocket. It also is an excellent place to alter the gearing. Again, check with your dealer and he will explain which sprocket would best suit your purposes.

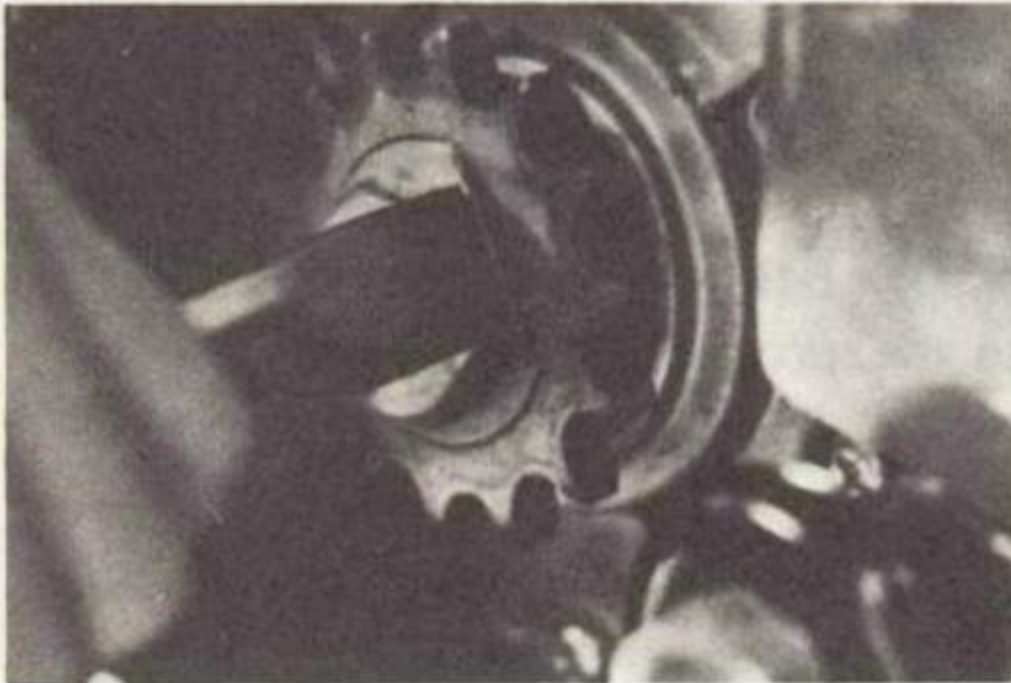

- a Straighten the bent edge of the lock washer with a blunt-ended metal punch.

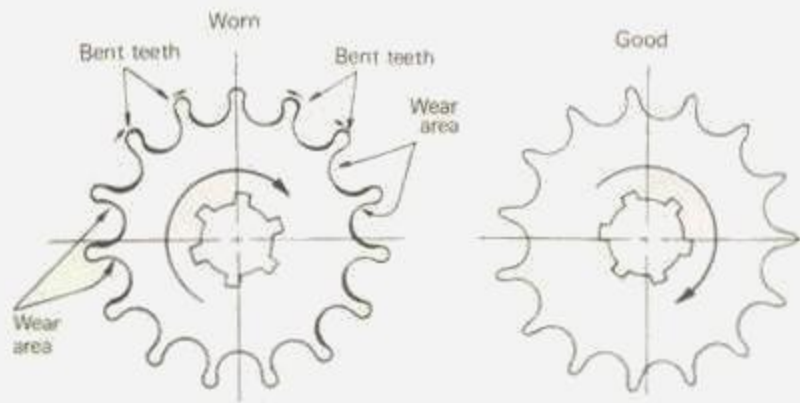

- b Hold the drive sprocket with the flywheel magneto holding tool, and remove the sprocket nut. If the flywheel magneto holding tool is not available, shift the transmission to low gear, and fit a box wrench on the sprocket nut. Then tap the handle of the wrench with a hammer and the shock will loosen the nut.

## 15. Inspection

If your machine receives exceptionally hard usage, check this sprocket frequently for signs of wear. These drawings show just what to look for to determine if the sprocket is wearing.

If the sprocket has worn to the degree as shown in the drawing, then it should be replaced. Sprocket replacement is possible if you have sufficient tools, otherwise your dealer can change it in a very short time.

The first step in removing the sprocket is to remove the shift lever and pull off the left-hand engine cover. The sprocket will now be completely in view. Flatten the tab washer used to lock the sprocket retaining nut. Remove the retaining nut. To keep the sprocket from turning while applying force to

the retaining nut, have someone engage the rear brake during this step.

During reassembly, make sure the retaining nut is tight and the locking tab of the washer is bent back into place.

## 16. Drive chain

Because the chain consists of an extraordinary amount of parts that rub against one another, it is prone to wear if it is not maintained constantly and correctly. Without any lubrication, a chain can wear out within 100 miles. You should develop a habit of servicing the chain on a regular schedule. This habit is especially important if you spend the major portion of your time riding in the dirt where dust and dirt can readily work into the chain links.

- a Lubrication - - there are several excellent pressure can lubricants available. Use a brush and rag to wipe off any accumulation of dirt, then spray a liberal amount of lubricant on the chain at least every 200 miles.
- b Cleaning - - the chain has to be periodically removed from the machine and soaked in cleaning solvent. Completely saturate the chain with solvent to remove as much dirt as possible. Drain and dry the chain thoroughly. Immediately after the chain has dried completely, lubricate to prevent any rust from forming.
- c Adjustment - - proper drive chain up and down free play, with the rider in position, should equal 3/4" (20mm) when measured at the center of the lower section of chain.

Follow these steps to obtain the correct free play:

CAUTION: During machine cleaning, do not remove chain lubricant.

See "cleaning" section for additional details.

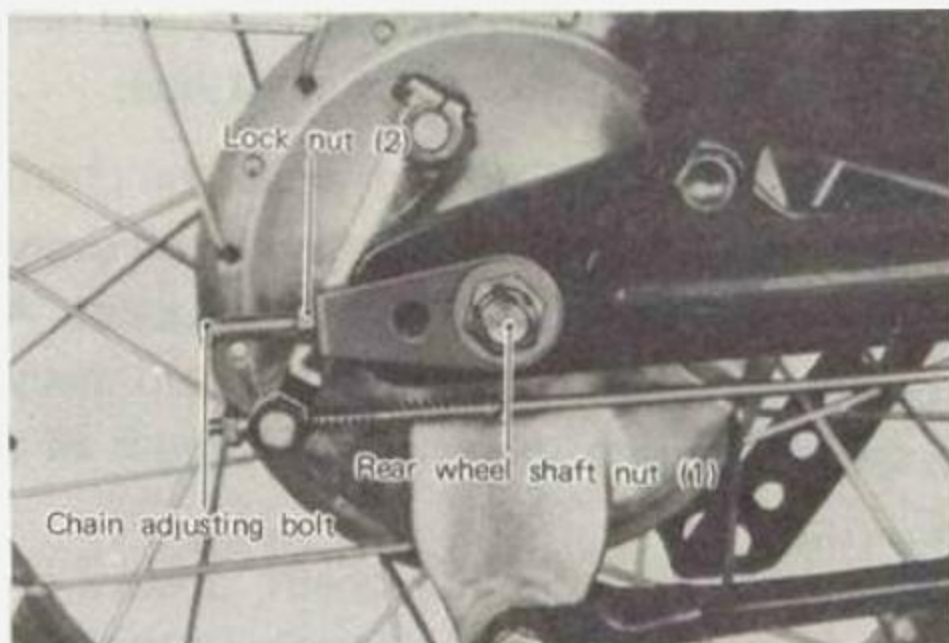

### Drive chain adjustment:

- a Remove the cotter pin and loosen the rear wheel nut (1).
- b Loosen the chain adjusting bolt lock nuts (2).
- c Rotate the adjusting bolts in or out, whichever is needed to obtain the correct free play, and at the same time make sure that both ends of the axle are positioned evenly. This can be checked by utilizing the marks on the very end of the swing arms, just above and to the rear of the rear wheel nuts.
- d After completing the adjustment, retighten all the lock nuts.
- e Finally, be sure to install a new cotter pin and check for correct brake pedal operation as it could have changed due to the chain adjustment.

### Checking the chain

Whenever you have the chain off for cleaning, take time to check for excessive wear or links binding up. Clean the chain first and hold the chain straight up in the air. Visually check to see if any of the part of the chain is kinked (any place the chain does not hang straight down.)

Another check is to lay the chain on a bench, in a straight line, and see how much the chain "bows".

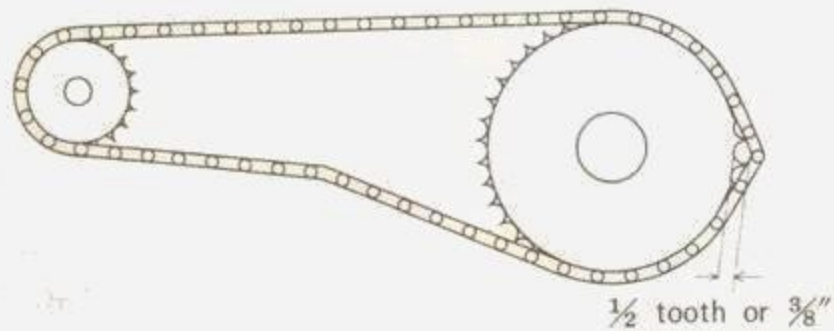

A new chain, or one that can still be used, will not deviate more than 3" - 4" from a straight line.

A simple test that can be utilized while the chain is still on the motorcycle is to lift the chain away from the curvature of the rear wheel sprocket. A chain is defective if you can pull the chain away from the sprocket more than half the length of a chain link.

**Note:** Whenever reinstalling the chain, always install the master link retaining clip so that the rounded end faces the direction of travel.

**Note:** TO DETERMINE THE VALUE OF KEEPING THE CHAIN IN PROPER WORKING CONDITION, REMEMBER THAT A CHAIN THAT HAS BECOME EXCESSIVELY WORN BOTH SPROCKETS' WHENEVER YOU INSTALL A NEW CHAIN, ALWAYS CHECK BOTH SPROCKETS. IF EITHER ONE IS WORN SUFFICIENTLY, REPLACE IT REAR IN MIND THAT A WORN SPROCKET CAN YOUR BRAND NEW CHAIN.

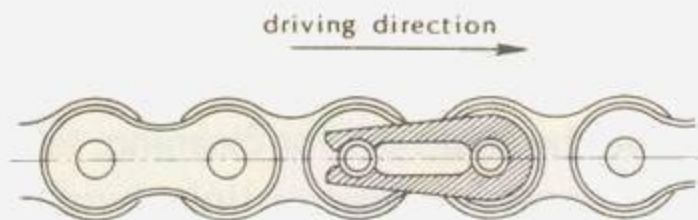

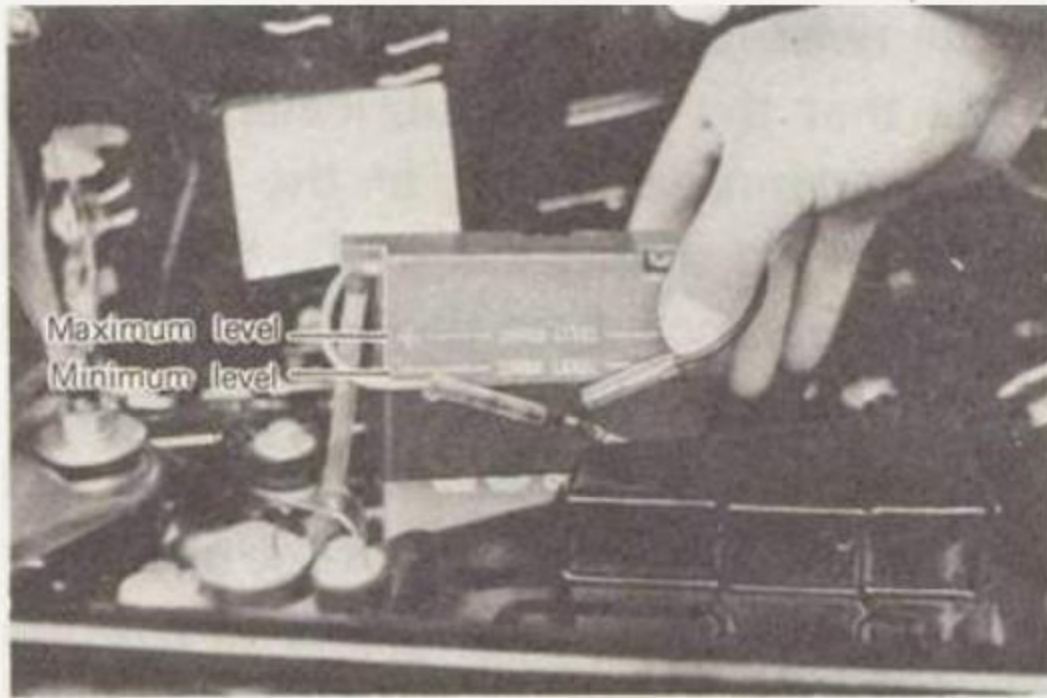

## 17. Battery

The life of your battery depends greatly on how well you keep it serviced. In order to service it completely and correctly, there are certain facts that you must know.

- a Always keep the battery fluid level between the "Maximum" and the "Minimum" level. It should be checked at least once a month, and more often during hot weather. If the battery needs filling, use distilled water. Do not use tap water as it usually contains minerals that can be harmful to the life of the battery.
  - b If for any reason the battery has become discharged, and you are going to charge it yourself, use a "trickle charger" that has no more than a one amp maximum rating. Also, make sure that all the battery caps have been taken off and that the rubber battery breather tube is not clogged or pinched shut. A charging battery creates gas, and pressure could build up in the battery if all the outlets were plugged up. Charge battery in a well ventilated area away from open flame.
  - c If the motorcycle is to be stored for more than a month, then remove the battery, have it fully charged, and store it in a cool dry storage area. If storage time is going to be lengthy, it is best to leave the battery with your dealer with specific instructions to recharge the battery every month or so. This procedure is necessary to insure maximum battery life.
- When reinstalling the battery, be sure to hook up the RED lead to the positive terminal and the BLACK lead to the negative terminal (the polarity of each is stamped just below each terminal).

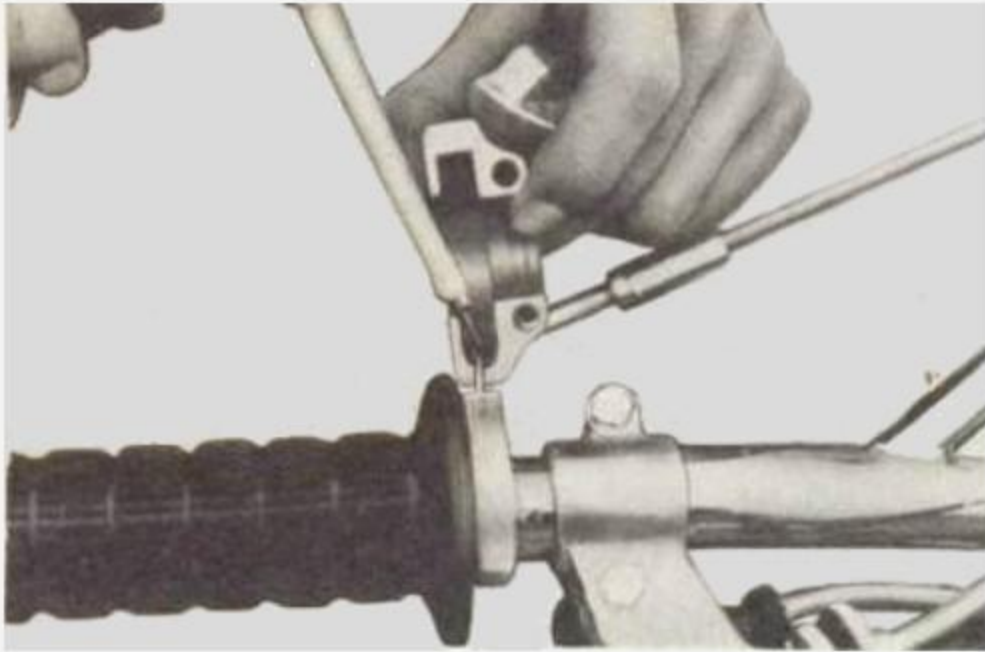

### 18 Throttle cable and grip lubrication

The throttle twist grip assembly should be greased at the time that the cable is lubricated, since the grip must be removed to get at the end of the throttle cable. Two screws clamp the throttle grip to the handlebar. Once these two are removed, the end of the cable can be held high to pour in several drops of lubricant. With the throttle grip disassembled, coat the metal surfaces of the grip assembly with a suitable all-purpose grease to cut down friction.

### 19 Carburetor

There are only three adjustments on the carburetor that do not require the services of a mechanic: the idle mixture, engine idle speed, and throttle cable slack. Because the carburetor is such a critical part of the engine, any carburetor disassembly should be done by an experienced mechanic.



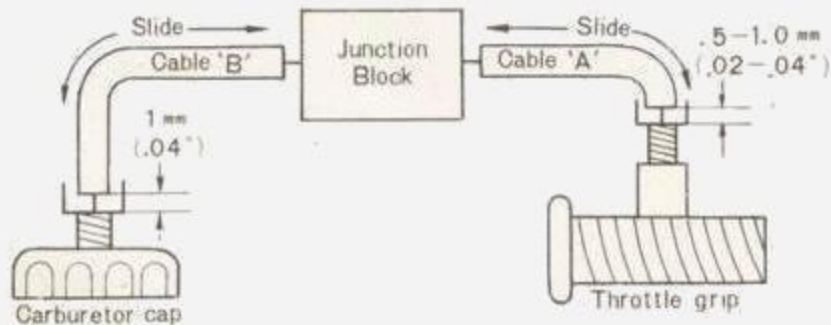
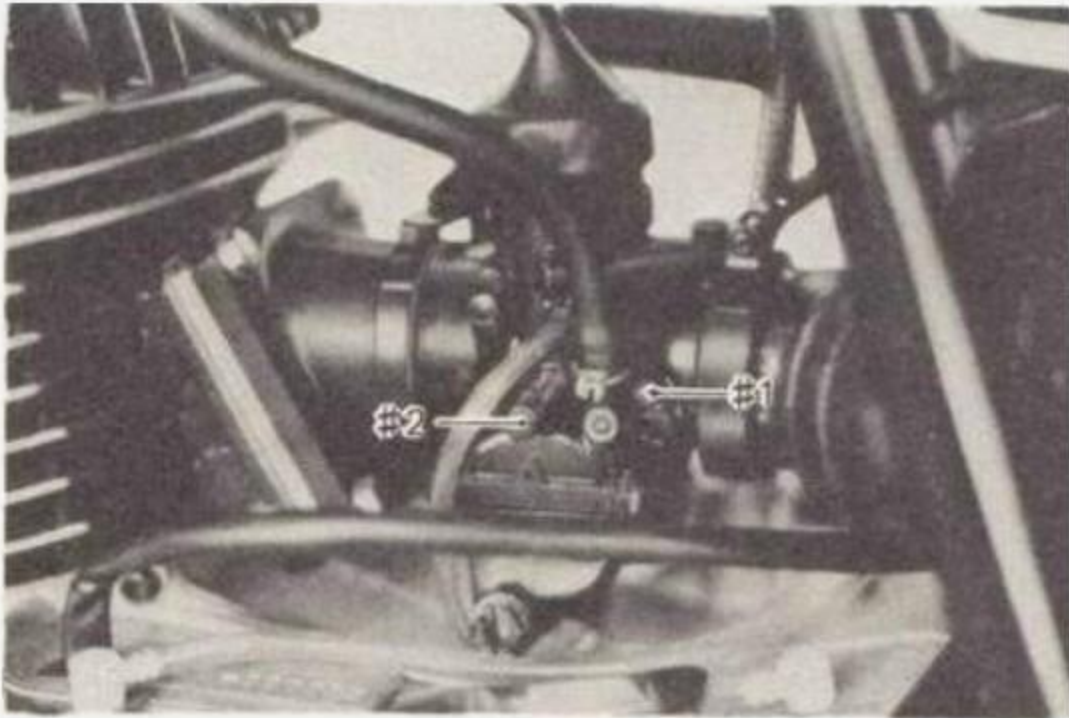

#### a Idle mixture

To set the idle mixture you must turn the idle pilot air screw (#1) in until it lightly seats, then back it out 1½ turns - - no more or no less. This is a factory setting that can be set with the engine stopped.

#### b Idle speed

Start the engine and let it warm up. Next, screw the throttle stop screw (#2) in or out, whichever direction is necessary for the engine to idle between 1,200 and 1,300 rpm (check tachometer).

#### c Throttle cable slack

After engine idle speed has been set, then loosen the cable adjuster lock nut and turn the adjuster on top of the carburetor until there is 1 mm (.04") of slack in throttle cable B'.

Retighten the lock nut.

Make the second throttle cable slack adjustment right at the throttle grip. There is a lock nut and adjuster where cable 'A' meets cable guide 'A'. Loosen the lock nut and turn the adjuster until there is .5 - 1.0mm (.02 - .04") slack in throttle cable 'A'. Retighten the lock nut.

**Note:** To measure the amount of cable slack, slide the cable back and forth over the throttle wire, and see how much end gap exists between the cable end and top of the carburetor (or cable guide 'A', if checking throttle cable 'A' slack).

## 20 Throttle cable replacement

Replacement of this cable should be left to your dealer as it is complicated, and carburetor and Autolube adjustments are affected.

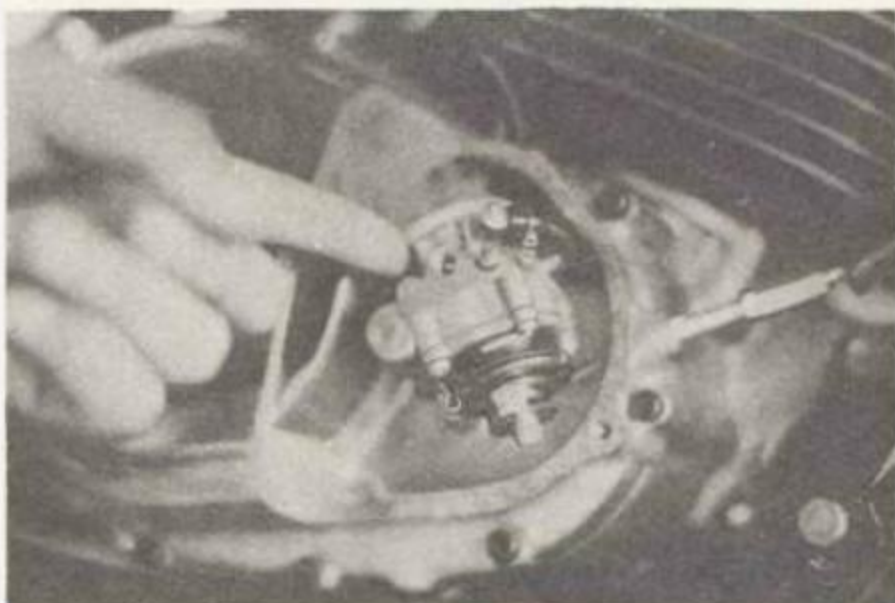
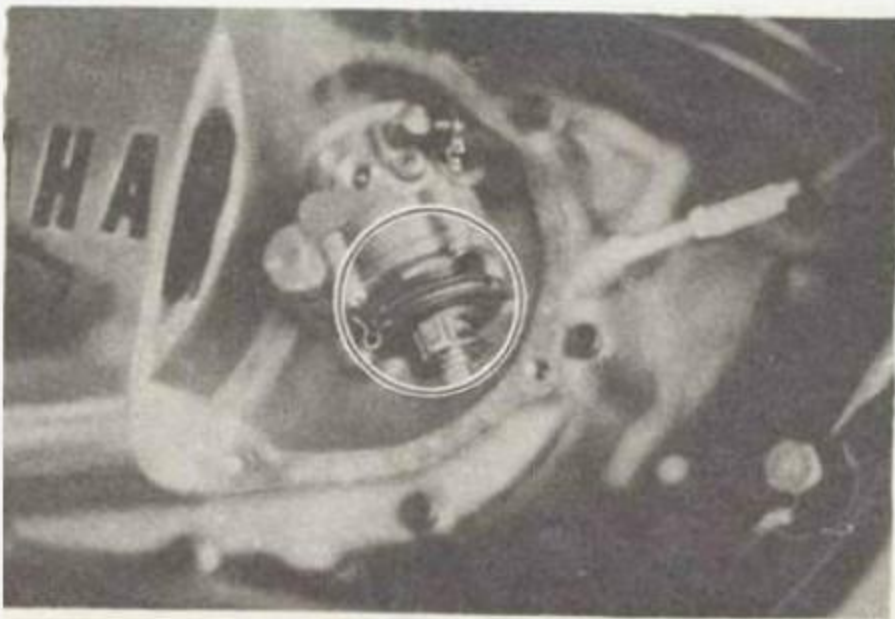

## 21 Autolube pump cable adjustment

Close the throttle grip completely, then twist it open until all cable slack is removed, but stop before the slides start to lift.

Adjust the pump cable so the mark on the pump pulley lines up with the 'adjust pulley guide pin'. The Autolube cable adjuster is located at the bottom end of the cable, screwed into the top of the right case cover.

**IMPORTANT NOTE:** If the pump runs out of oil, the pump must be bled to release air trapped in the pump. Remove the Phillips-head bleed screw, twist the throttle to full open position (turns the Autolube pump to maximum stroke), and rotate the plastic manual starter pump plate until only oil comes out the bleed hole (air stops coming out with the oil). Reinstall and tighten the bleed screw.

## 22 Fuel petcock

The petcock serves another purpose other than acting as a fuel on and off valve. A wire mesh filter is incorporated into the assembly. This filter must be removed occasionally and cleaned. Screw off the threaded cup at the bottom of the petcock and remove the filter. The filter might momentarily hang up in the petcock itself, if it does not drop down with the unscrewed cup.



When reinstalling the cup, do not overtighten as the rubber sealing washer inside could buckle and jam up into the fuel passage of the petcock.

## 23 Air filter

This model is equipped with a reuseable, oil impregnated, wet molt plain. It must be removed and cleaned thereafter every 2000 miles, more often if the motorcycle is ridden mainly in the dirt (preferably each time after you spend an entire day in the dirt).

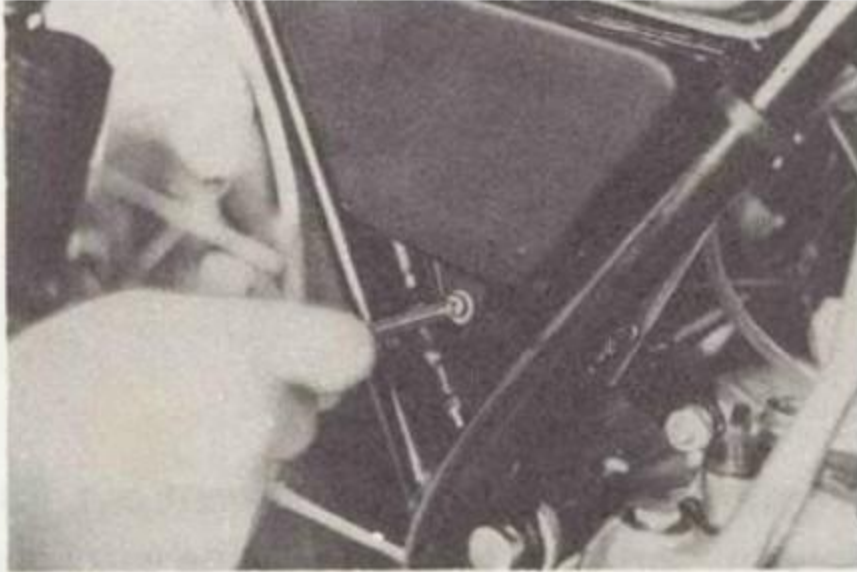

a Remove the air cleaner case cap fitting screws.

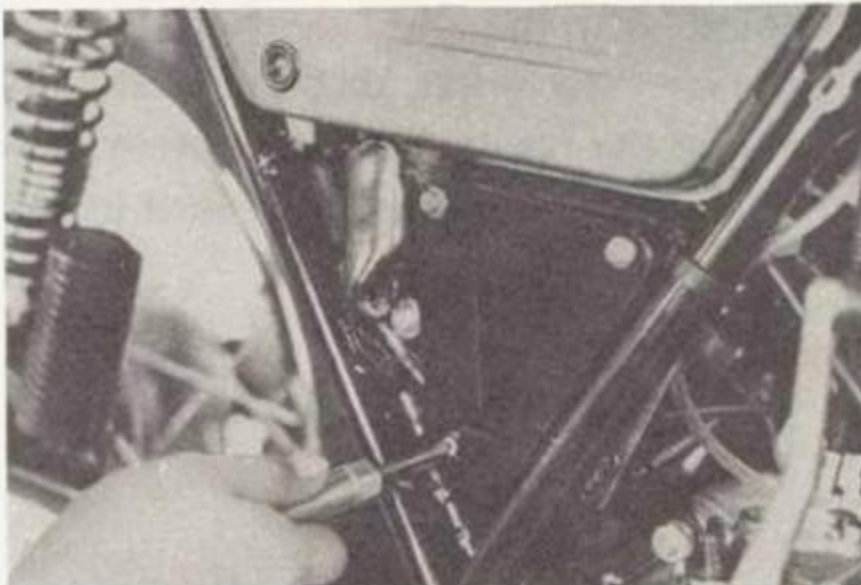

b Remove the cleaner case cap.

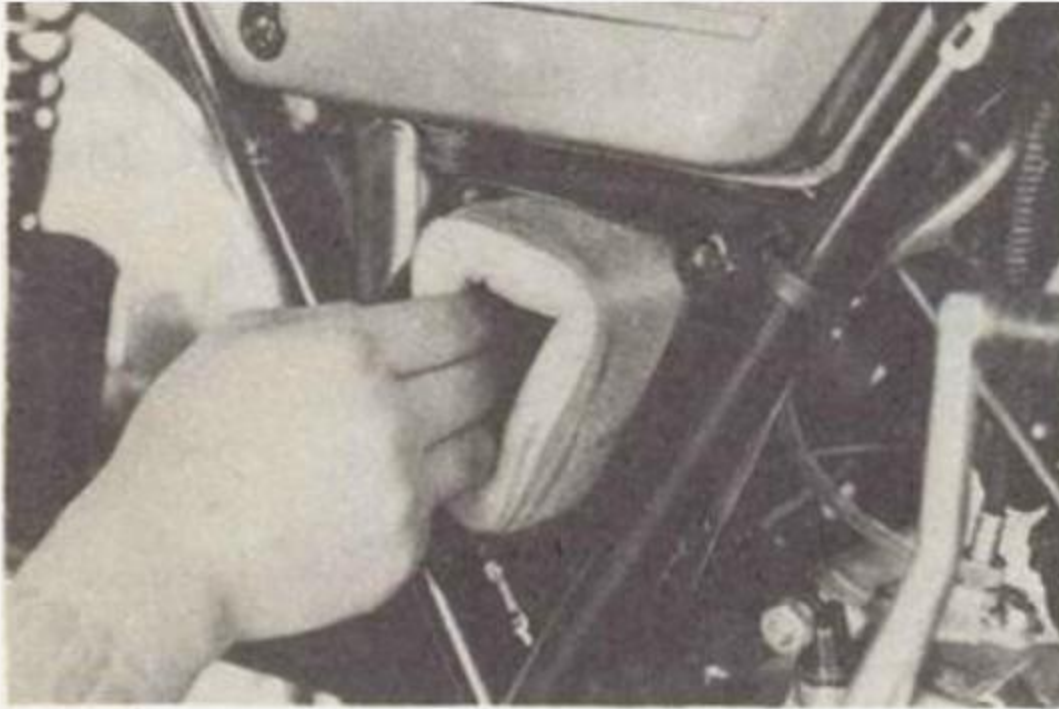

c The cleaner element can be pulled out.

Wash the foam filter thoroughly in solvent until all dirt has been removed. Squeeze all the solvent out. Pour oil onto the filter ( any grade of 20 or 30wt), work it completely in, and then squeeze out the surplus oil. The filter should be completely impregnated with oil, but not "dripping" with it.

Under no circumstances should you run the motorcycle without the air filter. First, dirt and dust will be able to pass through into the cylinder. Premature engine failure will be the result. Secondly, more air will flow to the engine and there will not be enough gasoline for all the air. The lean mixtue will result in higher engine temperatures and possibly severe engine damage.

### **23 Ignition timing**

Timing is of critical importance. If after both your service checkups have been completed, and if for any reason you wish to check the timing, have your dealer check for you.

### **24 Breaker point**

Unless you are sufficiently experienced, it would be advisable for a mechanic to replace the points, as ignition timing will change when the points are replaced. As it is, points (and condenser) normally last several thousand miles.

**Note:** In addition to the above, changes in point gap through wear and/or filing for cleaning purposes will also change timing, have your Authorized Yamaha Dealer service the ignition for you.

## 25 Spark plug

The spark plug in your machine can tell you a great deal as to how the engine is operating when you know how to "read" the plug. If the engine is operating correctly, and if it is being ridden correctly, then the tip of the white insulator in the spark plug will be a light tan color (standard plug is NGK(B-8ES) If, when you remove the spark plug, it is very dark brown or black, then a plug with a hotter heat range might be needed. This situation is quite common during the engine break-in period. If the insulator tip shows a very light tan color, or is actually white, or if the electrodes begin to melt, then a spark plug with a colder heat range is required. Again, if the spark plug insulator tip does not have a light tan color, have your dealer install a spark plug with a different heat range to correct the situation. Do not attempt to experiment with different heat range spark plugs yourself, as it takes an experienced eye to gauge which spark plug to use, and to gauge if the spark plug is actually at fault. It is all right though for you to replace the standard plug. Engine conditions can cause any spark plug to slowly break down. If deposits begin to build up, or if the electrodes finally become too worn, or if for any reason you believe the spark plug to not be functioning correctly, replace it. Be sure, when replacing the plug, that you always clean the gasket surface, that you use a new gasket, and that the spark plug is torqued to 19-21 ft-lbs. Also wipe off any grime that might be present on the surface of the spark plug. The plug can be taken out to be cleaned and gapped. As long as deposit build-up on the insulator is not extreme, you can use a glass bead type spark plug cleaner to quickly remove the deposits.

Use a wire type feeler gauge to set the electrode gap at 0.020" - 0.024" (0.5 mm - 0.6 mm.)



## 26 Transmission oil

The only servicing for you to do is to check and fill the transmission lubricating oil. The transmission dip stick is located right above the kickstarter. To check the level, warm the engine up for several minutes, screw the dip stick completely out and then just rest the stick in the hole.

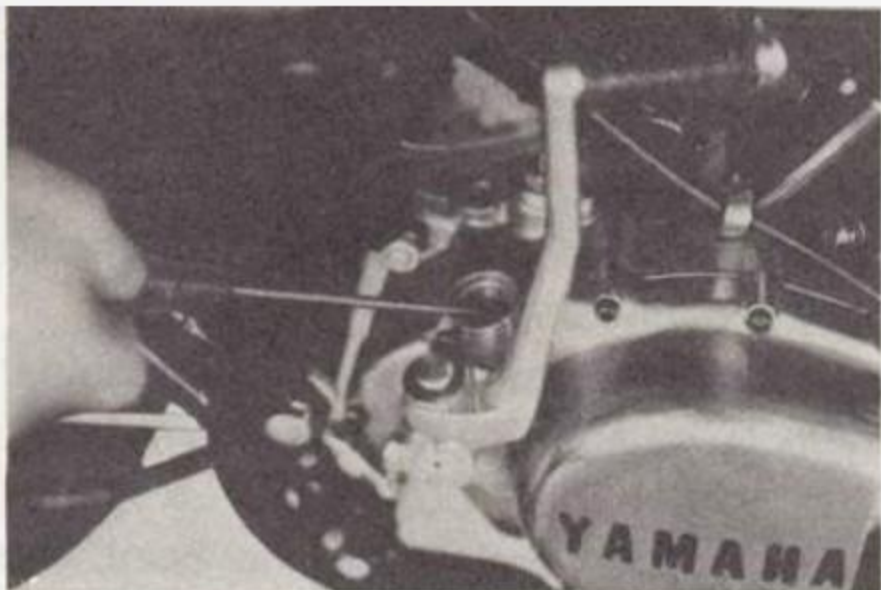

**Note:** When checking transmission oil level with the dip stick, let the unscrewed dip stick just rest on the case threads. Also, be sure the machine is positioned straight up and on both wheels.

Commendable oil	Yamaha gear oil or SAE "SE" 10W/30 motor oil
Amount	1,000 cc (1.0 qts)

The dip stick has a Minimum and a Maximum mark, and the oil level should be between the two. If the level is lower, then add sufficient 10w/30 oil to raise it to the proper level.

During the break-in period, you should replace the gear oil 30 days after the date of purchase or after 500 miles. The transmission should be drained and refilled approximately every 2,000 - 4,000 miles. On the bottom of the engine there is a drain plug. Remove it and drain all the transmission oil out.

Reinstall the drain plug (make sure it is tight). Add 10w/30 oil through the dip stick hole.

**Note:** DO NOT ADD ANY CHEMICAL ADDITIVES. TRANSMISSION OIL ALSO LUBRICATES THE CLUTCH AND ADDITIVES COULD CAUSE THE CLUTCH TO SLIP.

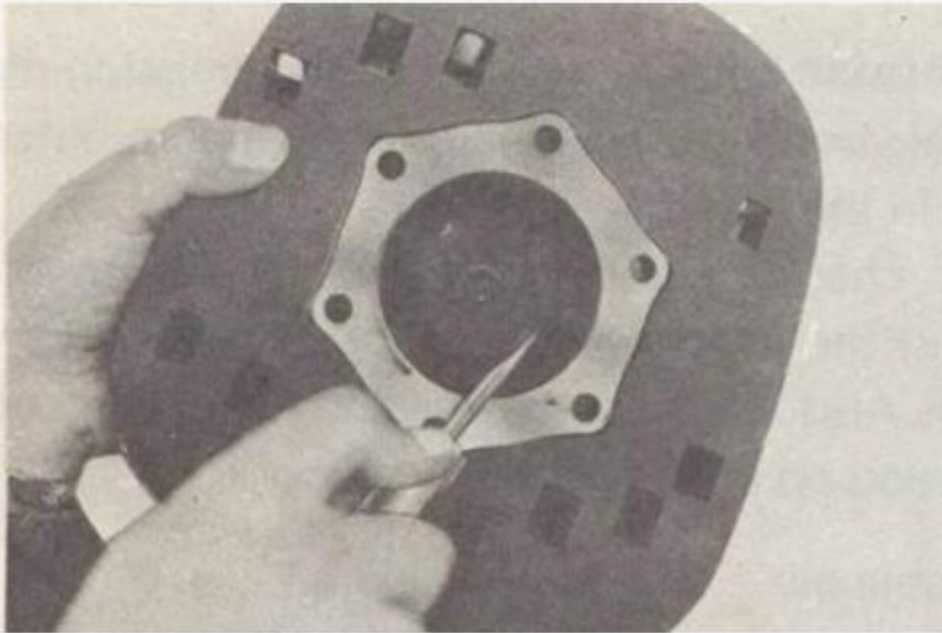

## 27 Decarbonization

Carbon deposits in the combustion chamber, on the head of the piston, in the exhaust port, and in the muffler are a constant cause of engine power loss. Decarbonization of these parts is relatively simple, requiring only a few tools. A torque wrench is one of the necessary tools. Going any further though, such as removing the carbon from ring grooves, should be done by a certified mechanic, as this requires cylinder removal.

Begin this servicing step by gradually loosening the four cylinder retaining nuts, in a pattern. **DO NOT LOOSEN EACH NUT COMPLETELY ALL AT ONCE**, but work around the cylinder head, loosening each nut  $\frac{1}{2}$  turn at a time. Slip the head off and use a dull or round edge scraper to remove the carbon from the combustion chamber (do not remove the spark plug). The round end of a hacksaw blade works quite well. Use a rag dipped in solvent and thoroughly clean the area. Do not scratch the gasket surface.

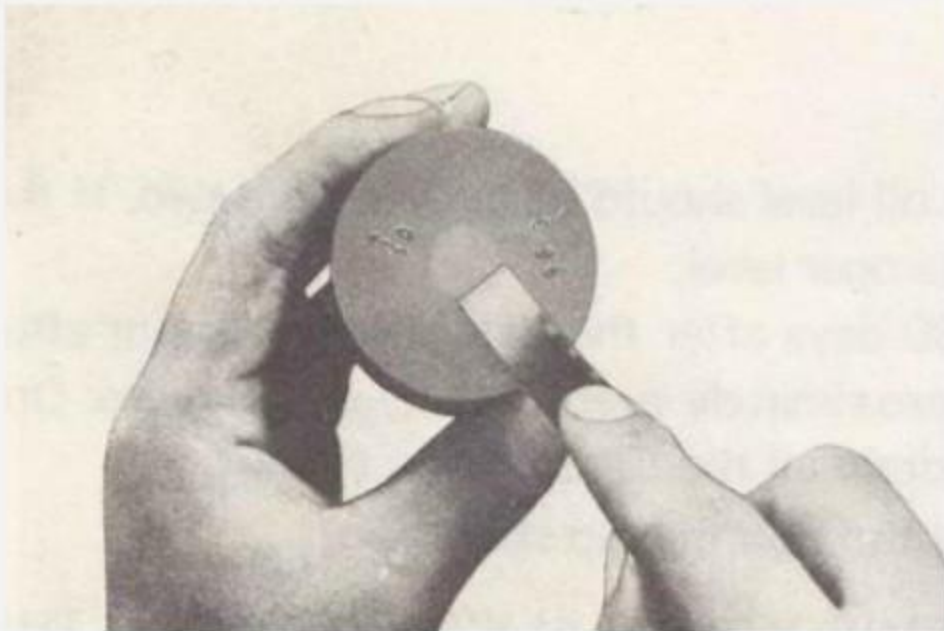

Bring the piston up to the very top and use the same scraping tool to remove the carbon from the top of the piston. Blow off as much of the loosened carbon as possible, then use the solvent soaked rag to pick up as much of the rest as possible.

Next, rotate the piston as far down as possible. Slip a dry rag down over the piston for protection. Disconnect the muffler. Very carefully use a small scraper and remove the carbon from the port opening (take care that it does not fall back into the cylinder). As soon as possible, scrape the carbon from the exhaust port from the outside opening.

The head can now be put back onto the cylinder. Carefully wipe off the gasket surfaces of both parts. Position the head gasket (which should be a new one) on the cylinder. Slip the head into place and tighten the four retaining bolts until they are finger tight. Use the torque wrench to tighten them further. Total torquing pressure is 15 - 18 ft/lbs. but you should torque all four nuts in a 'cross' pattern, and in two progressive steps of increasing torque (example : 10 ft-lb, 18 ft-lbs) to prehead warpage.

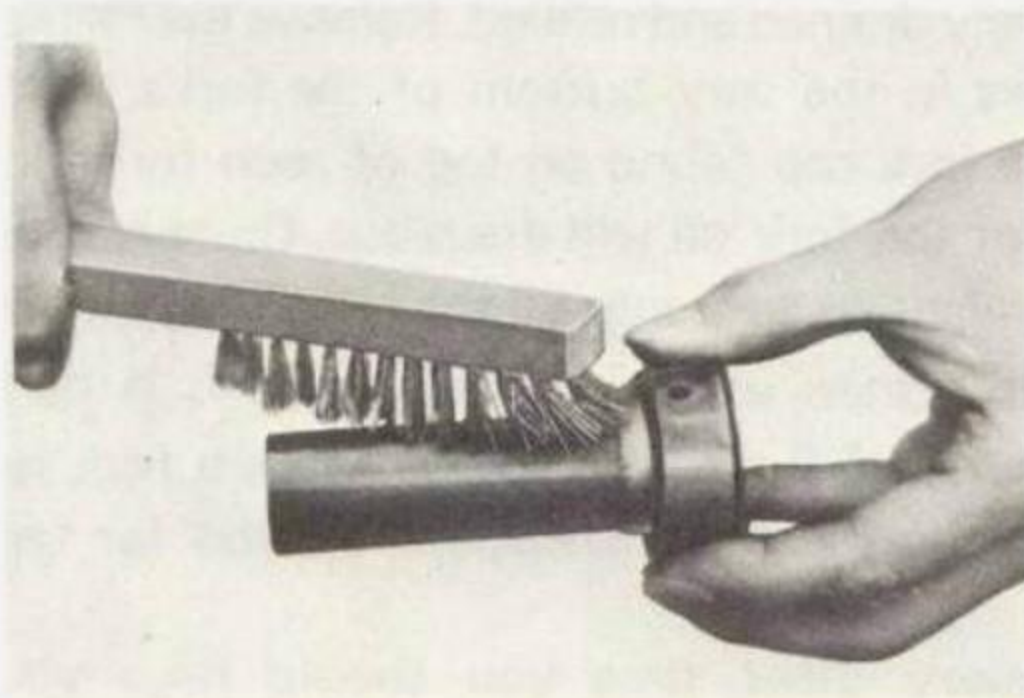

Next, remove the inner cylinder from the back end of the muffler. This is done by removing the set screw and pulling out the assembly. Remove all the carbon deposits with a wire brush. While the assembly is out of the muffler, look inside for additional deposits. If any are present, the muffler should be removed and a stout scraper used to break it loose, Tip the muffler up and shake out all the loose carbon. Reinstall the muffler, slip the inner cylinder back, and tighten down the set screw. This decarbonization procedure, even though it only takes a short time to complete, is absolutely

necessary to prolong the performance life of the engine. Whether you perform this maintenance yourself, or have your dealer do it, be sure to faithfully follow the maintenance time recommendations listed in the chart at the beginning of the SERVICING section.

## 28 Steering

Periodically you should check for any looseness in the steering assembly. Do this by blocking the front end off the ground, grasping the bottom of the forks, and gently rocking the fork assembly backward and forward. You will feel any looseness in the steering assembly bearings. If any exists, do not attempt to correct it yourself but let your dealer make the adjustment with the correct tools.

Also, these same front fork bearings must also be lubricated every 4,000 miles. This the dealer should also do.

## 29 Front fork

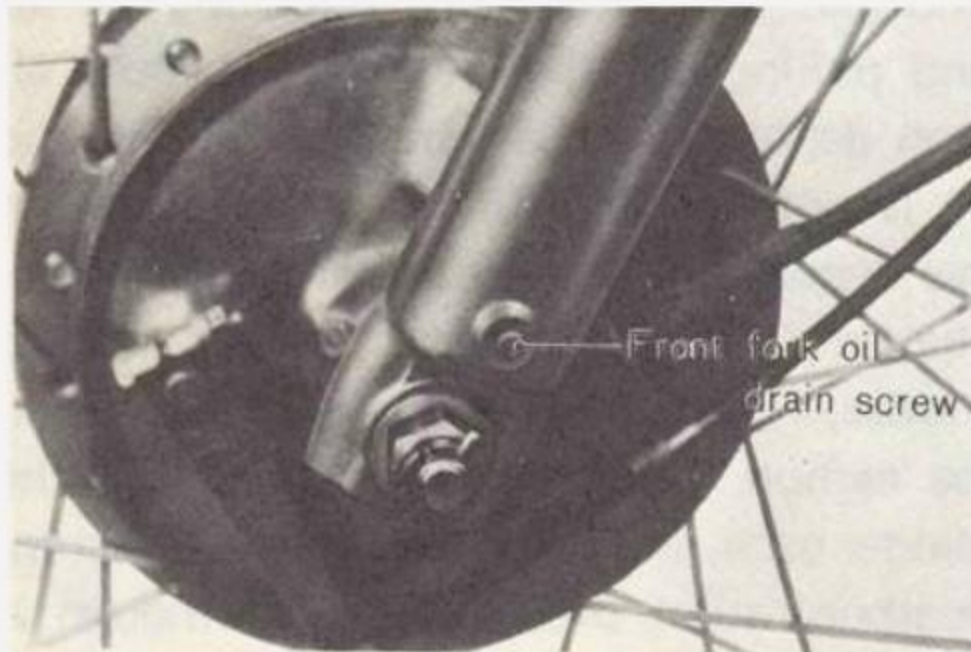

At least every 4,000 miles the front fork oil should be completely drained and refilled. Remove the Phillips head screws in the very bottom of the forks. Next, remove the fork cap found on top of each fork tube and most of the fork oil will drain out. Compress the forks several times to pump all the remaining oil out. Reinsert the drain screw and make sure it is tight. Slowly pour in 5.9 oz. (175cc) oil in each fork leg. (see Lubrication Recommendations section for type oil).

At least every other time you should have your mechanic dismantle the fork assembly and tho-

roughly clean out each fork. Water and dirt eventually coat much of the inner fork surfaces and cannot be readily removed just by draining.

## WARRANTY INFORMATION

Study your Owner's Warranty Guide Book thoroughly. It contains your Warranty Policy, an explanation of the policy, break-in procedures and the warranty required service schedules. Becoming familiar with these items will be to your advantage in making the best use of Yamaha's warranty program.

The acceptance of any warranty claim that your dealer might submit in the future depends greatly on just what has been done to the motorcycle.

IF ANY PARTICULAR FAILURE CAN BE TRACED DIRECTLY TO A REPAIR OR MAINTENANCE PERFORMED INCORRECTLY, THE WARRANTY CLAIM MAY NOT BE ACCEPTED. For this reason, we recommend that all services beyond those detailed in this manual be performed by a qualified mechanic at an authorized Yamaha dealer.

There are certain requirements that must be met to qualify for warranty coverage.

1. Your machine must be registered for warranty. This is accomplished when the Warranty Registration card is filled out by you and mailed by the dealer to Yamaha at the time of purchase.
2. Your Owner's Warranty Guide Book outlines the required service schedules and provides a maintenance record for your protection and convenience. Proper maintenance will insure a trouble free life for your new Yamaha.
3. If any problems occur which you feel should be covered under warranty, NOTIFY YOUR DEALER IMMEDIATELY. Do not delay, as little problems left unrepaired can become large problems which may not be covered under warranty.

## REQUIREMENTS FOR A GOOD MOTORCYCLIST

1. Safety is more important than speed. Always observe traffic regulations & signs.
2. Always use quality gasoline and oil, and avoid the inconvenience of running out of gas or oil.
3. Check tire pressures before every ride.
4. Warm up the engine for about one minute before riding.
5. Shift gears gently, while momentarily closing the throttle, avoid power shifting.
6. During the break-in period, ride at the suggested speed in each gear.
7. Apply the front and the rear brake at the same time
8. Down a long hill, use engine compression as a brake.
9. When parking, be sure to turn off and remove the ignition key, turn off the fuel pet cock, and lock the steering.
10. Check parts at regular intervals as described in this manual.

## Troubleshooting

### 1 Factory Authorized Service

Your Yamaha dealer is a factory trained mechanic who guarantees thorough and correct maintenance for your motorcycle. We recommend that you let your dealer make all repairs and adjustments on your motorcycle. You will be assured prompt and good service.

### 2 Genuine Yamaha Parts

Always use genuine Yamaha parts and not "substitute" brands. Yamaha parts are manufactured to meet the factory's exacting standards of precision and quality.

### 3 If Something Should Go Wrong . . . . .

The DT3 undergoes rigid factory tests to assure you long and satisfactory performance. However, if something should go wrong with your machine, immediately ask your Yamaha dealer for advice.

He is always glad to answer your questions.

**IMPORTANT:** Some components are sealed or cannot be disassembled. If repairs to such components are necessary go to your Yamaha dealer. Yamaha cannot be responsible for repairs and adjustments to such components performed by unauthorized personnel.

**Note:** The inspection and maintenance of Autolube should be entrusted to your dealer.



## Consumer Information

### Stopping Distance

This figure indicates braking performance that can be met or exceeded by the vehicles to which it applies, without locking the wheels, under different conditions of loading and with partial failures of the braking system. The information presented represents results obtainable by skilled drivers under controlled road and vehicle conditions, and the information may not be correct under other conditions.

Description of vehicles to which this table applies: Yamaha motorcycle DT250

#### A. Fully Operational Service Brake

Load

Light

Maximum

150

175

0

100

200

300

Stopping Distance in Feet from 60 mph.

## Acceleration and passing ability

This figure indicates passing times and distances that can be met or exceeded by the vehicles to which it applies, in the situations diagrammed below.

The low-speed pass assumes an initial speed of 20 mph and a limiting speed of 35 mph. The high-speed pass assumes an initial speed of 50 mph and a limiting speed of 80 mph.

NOTICE: The information presented represents results obtainable by skilled drivers under controlled road and vehicle conditions, and the information may not be correct under other conditions.

Description of vehicles to which this table applies: Yamaha motorcycle DT250

### Summary table:

Low-speed pass . . . . . 360 feet; 7.4 seconds  
 High-speed pass . . . . . 1300 feet; 14.1 seconds

### LOW-SPEED

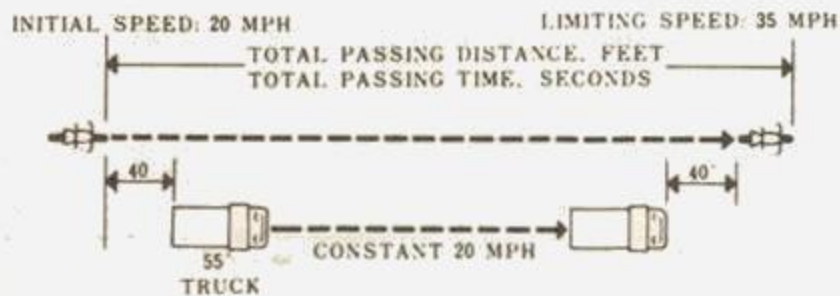

### HIGH-SPEED

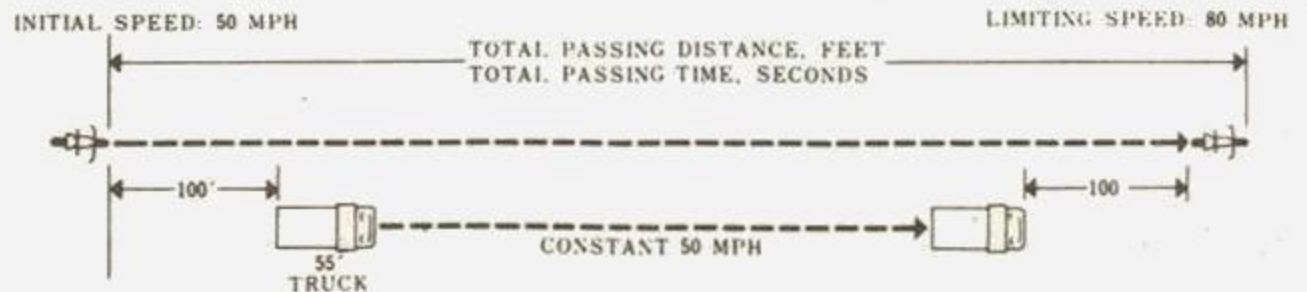





SINCE 1887

**YAMAHA MOTOR CO., LTD.**

HAMAMATSU, JAPAN

LIT-11624-38-01

Printed in Japan

'73-5.10.0×1 