

1.00

YAMAHA

125 YAS1 & YAS1-C

Service Manual

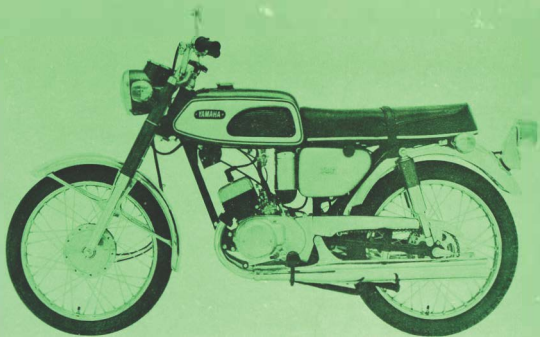

***** NOTICE *****

This manual has been written by Yamaha Motor Company for use by Authorized Yamaha Dealers and their qualified mechanics. In light of this purpose it has been assumed that certain basic mechanical precepts and procedures inherent to our product are already known and understood by the reader.

Without such basic knowledge, repairs or service to this model may render the machine unsafe, and for this reason we must advise that all repairs and/or service be performed by an Authorized Yamaha dealer who is in possession of the requisite basic product knowledge.

Other information is produced by the U.S. distributor, Yamaha International Corporation and is necessary to provide total technical coverage regarding the product.

The Research, Engineering, and Service Departments of Yamaha are continually striving to further improve all models manufactured by the company. Modifications are therefore inevitable and changes in specifications or procedures will be forwarded to all Authorized Yamaha Dealers and will, where applicable, appear in future editions of this manual.

YAMAHA 125 YAS1 & YAS1-C SERVICE MANUAL

2nd Edition

SEP 1970

SERVICE DEPARTMENT
YAMAHA MOTOR COMPANY
HAMAMATSU, JAPAN

FOREWORD

This new YAMAHA AS1(C) motor cycle is the fully equipped 125-cc, parallel-twin engine sports model of the day.

The crowning feature that makes the 125 AS1(C) the most advanced motor cycle is the adoption of 5-port cylinders to its engine. The addition of the auxiliary transfer ports has proved to be of great improvement in scavenging efficiency.

This unique design of the cylinder results in high performance of the engine, especially when combined with the ideal lubrication system-YAMAHA Autolube.

Among other features is the well-proportioned 5-speed transmission, which is most essential for sport cycles.

These outstanding features have not only made the AS1(C) comparable to a 180-cc motor cycle in performance, but succeeded in making it as light as a 90-cc bike.

This manual is published to provide the information and guidance required for all YAMAHA service engineers who are charged with the task of maintaining YAMAHA AS1(C) models in top condition. It is sincerely hoped, therefore, that all YAMAHA service men will find it most useful in carrying out their work.

CONTENTS

Chapter 1. General	4
1-1. Features	4
1-2. Specifications and External View.....	5, 6, 7, 8
1-3. Performance Curves	9
1-4. Service Tools and Instruments.....	10
Chapter 2. YAMAHA Autolube (Automatic separate lubricating system) 12	
2-1. What is YAMAHA Autolube ?	12
2-2. Features of YAMAHA Autolube.....	12
2-3. Handling the Oil Pump	13
Chapter 3. 5-Port Cylinder	15
3-1. Description of 5-Port Cylinder.....	15
3-2. Construction and Features.....	15
3-3. Performance Comparison	17
Chapter 4. Engine	18
4-1. Removing the Engine	18
4-2. Cylinder Head	21
4-3. Cylinder	22
4-4. Piston Pin.....	24
4-5. Piston Ring	24
4-6. Piston	25
4-7. Crankcase Cover (R).....	27
4-8. Clutch	28
4-9. Primary Drive Gear	34
4-10. Distance Collar	34
4-11. Kick-Starter	35

4-12.	Drive Sprocket.....	37
4-13.	Shifting Mechanism	38
4-14.	Splitting the Crankcase	40
4-15.	Transmission Assembly	42
4-16.	Crankshaft.....	45
4-17.	Bearings and Oil Seals.....	53
4-18.	Carburetor	55
4-19.	Air Cleaner	58
Chapter 5.	Chassis	60
5-1.	Front Wheel.....	60
5-2.	Rear Wheel	63
5-3.	Rear Arm	64
5-4.	Fuel Tank	65
5-5.	Front Fork	66
5-6.	Rear Cushion (Shock absorber)	68
Chapter 6.	Electrical Equipment	69
6-1.	General	69
6-2.	Main Component Parts.....	69
6-3.	Caution on Handling Electrical Equipment.....	77
6-4.	Connection Diagram	79
6-5.	Wiring Diagram	83

Chapter 1. General

1-1 Features

1. 5-port Cylinders

This new YAMAHA 125 AS1(C) Sports is equipped with a 2-stroke twin 125-cc engine, featuring 5-port cylinders. The 5-port cylinders have auxiliary transfer ports to step up scavenging efficiency. The results are obvious. With improved acceleration and high-speed performance, the AS1(C) can be comparable to 180-cc class sport cycles.

2. Highly-dependable YAMAHA Autolube Engine

The famous YAMAHA Autolube provides perfect engine lubrication, thus assuring high dependability and outstanding durability of the engine.

3. Well-proportioned 5-speed Transmission

The well-proportioned 5-speed transmission permits satisfactory gear shifting at any time and anywhere on streets, hilly land or highways.

4. One-touch (primary-coupled) Kick-starter

The engine can be started by simply squeezing the clutch lever and kicking the starter pedal without shifting the transmission back to neutral. This is a welcome convenience particularly for Motocross racers.

5. Starter-built-in Carburetors

YAMAHA's proven starter-built-in carburetors are fitted assuring one-kick starting.

6. Powerful Brakes

Patented Waterproof, dustproof brake drums provide safe, fade-free braking on wet or muddy roads.

7. 3-position Adjustable Rear Suspension

The 3-position adjustable rear suspension provides excellent riding comfort, with adjustable spring tension to match running conditions (roads and speeds).

1-2 YAMAHA 125 YAS1 & YAS1C SPECIFICATIONS

Model	125 YAS1	125 YAS1C
Dimensions:		
Overall length	1,855mm (73.0 in)	1,855mm (73.0 in)
Overall width	740mm (29.2 in)	810mm (31.9 in)
Overall height	1,070mm (42.2 in)	1,005mm (39.6 in)
Wheelbase	1,200mm (47.2 in)	1,200mm (47.2 in)
Min. ground clearance	150mm (5.9 in)	150mm (5.9 in)
Weight net:		
gross:	98kg (216 lbs)	100kg (220 lbs)
	110kg (242 lbs)	112kg (247 lbs)
Performance:		
Max. speed	120~130km/h (75~82m/h)	115~120km/h (72~75m/h)
Fuel consumption (on flat roads)	65km/ℓ @40km/h (150m/g@25m/h)	65km/ℓ @40km/h (150m/g@25m/h)
Climbing ability	22.5°	23.5°
Min. turning radius	1,750mm (69 in.)	1,750mm (69 in.)
Braking distance	11.5m at 50km/h (38ft at 30m/h)	11.5m at 50km/h (38ft at 30m/h)
Engine:		
Model	YAMAHA AS1	YAMAHA AS1
Type	2-stroke, gasoline	2-stroke, gasoline
Lubrication system	Separate lubrication (YAMAHA Autolube)	Separate lubrication (YAMAHA Autolube)
Cylinders	2 cylinders in parallel, 5-port	2 cylinders in parallel, 5-port
Displacement	124cc	124cc
Bore × stroke	43 × 43mm (each)	43 × 43mm (each)
Compression ratio	7.0:1	7.0:1
Max. output	15ps/8,500rpm	15.2ps/8,500rpm
Max. torque	1.3kgm/8,000rpm (9.4ft-lbs/8,000rpm)	1.3kgm/7,500rpm (9.4ft-lbs/7,500rpm)
Starting system	Kick-starter	Kick-starter
Ignition system	Battery ignition	Battery ignition
Carburetor:	VM17SC × 2	VM17SC × 2
Air cleaner:	Dry, Paper filter type	Dry, paper filter type
Power Transmission:		
Clutch	Wet, multi-disc type	Wet, multi-disc type
Primary reduction	Gear	Gear
Primary reduction ratio	74/19=3.894	74/19=3.894
Gear box		
Type	Constant mesh, 5-speed forward	Constant mesh, 5-speed forward
Reduction ratio 1st	3.182 (35/11)	3.182 (35/11)
Reduction ratio 2nd	1.875 (30/16)	1.875 (30/16)
Reduction ratio 3rd	1.300 (26/20)	1.300 (26/20)

Model	125 YAS1	125 YAS1C
Reduction ratio 4th	1.045 (23/22)	1.045 (23/22)
Reduction ratio 5th	0.840 (21/25)	0.840 (21/25)
Secondary reduction	Chain	Chain
Secondary reduction ratio	39/15 = 2.600	39/15 = 2.600
Chassis:		
Type of frame	Steel tube, diamond frame	Steel tube, diamond frame
Suspension system (front)	Telescopic fork	Telescopic fork
Suspension system (rear)	Swing arm	Swing arm
Cushion system (front)	Coil spring, oil damper	Coil spring, oil damper
Cushion system (rear)	Coil spring, oil damper	Coil spring, oil damper
Steering System:		
Steering system	47° both right and left	47° both right and left
Caster	63°	63°
Trail	86.5mm (3.4 in.)	86.5mm (3.4 in.)
Braking System:		
Type of brake	Internal expansion, twin shoe	Internal expansion, twin shoe
Operation method (front)	Right hand operation	Right hand operation
Operation method (rear)	Right foot operation	Right foot operation
Tire size (front):	2.50—18—4PR	2.50—18—4PR
Tire size (rear):	2.75—18—4PR	2.75—18—4PR
Fuel tank capacity:	9.5 ℓ (2.5 gal.)	9.5 ℓ (2.5 gal.)
Oil tank capacity:	1.5 ℓ (1.6 qts.)	1.5 ℓ (1.9 qts.)
Generator:		
Model	K108-01	K108-01
Manufacture	Hitachi Ltd.	Hitachi Ltd.
Rectifier:		
	Silicon rectifier	Silicon rectifier
Spark plug:		
	B-8HC	B-9HC
Battery:		
Manufacture	Furukawa Battery or GS.	Furukawa Battery or GS.
Model	BST3-12 or MG3-12	BST3-12 or MG3-12
Capacity	12V, 5.5AH	12V, 5.5AH
Lights:		
Head light	12V, 35/35W	12V, 35/35W
Tail/stop light	12V, 8/20W	12V, 7/23W
Flasher light	12V, 8W × 4	12V, 8W × 4
Neutral light	12V, 3W	12V, 3W
Meter light	12V, 3W	12V, 3W
Flasher pilot light	12V, 2W	12V, 3W

YAMAHA 125 YASI External View

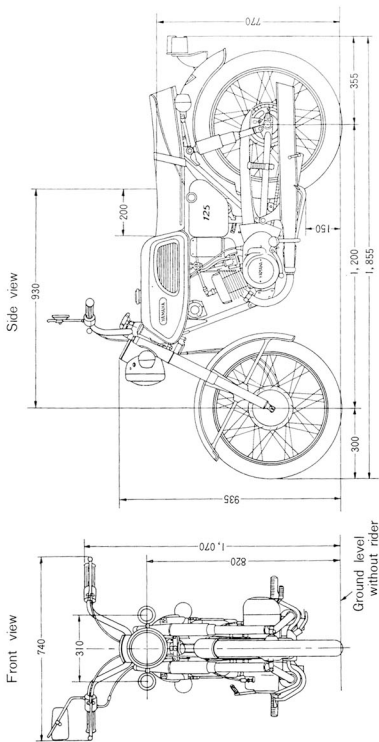

YAMAHA 125 YASIC External View

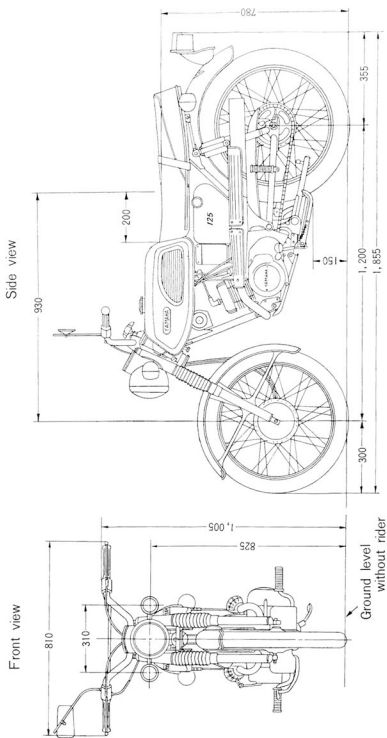

1-3 Engine Performance Curves

125YAS1 Engine Performance Curves 125YAS1 Running Performance Curves

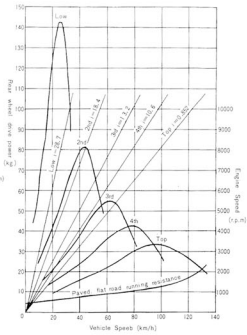
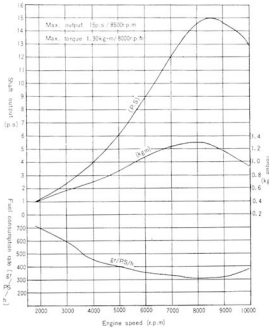

125YAS1C Engine performance Curves 125YAS1C Running Performance Curves

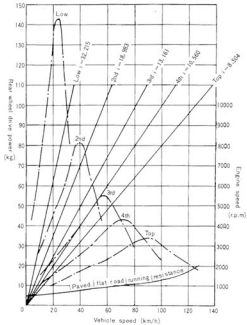
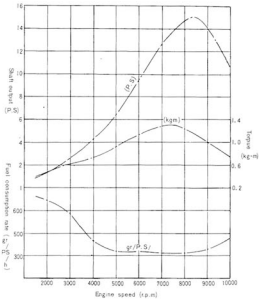

1-4 Service Tools and Instruments

The following tools and instruments are required for shop servicing the YAMAHA sports 125YAS1. & 125YAS1C.

1. Ordinary Tools

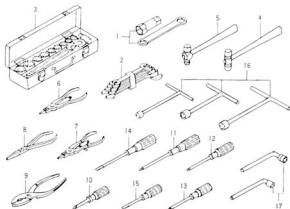

1. Plug wrench
2. Set of open-end wrenches
3. Set of socket wrenches
4. Plastic tip hammer
5. Steel hammer
6. Circlip pliers (ST type)
7. Circlip pliers (RT type)
8. Needle nose pliers
9. Pliers
10. Phillips-head screwdriver
11. Phillips-head screwdriver, large
12. Phillips-head screwdriver, medium
13. Phillips-head screwdriver, small
14. Slot-head screwdriver, medium
15. Slot-head screwdriver, small
16. T-handle socket wrench
17. L-handle socket wrench

Fig. 1-4-1

2. Special Tools and Instruments

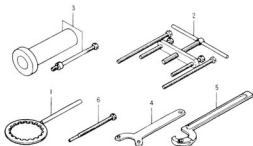

1. YA6 clutch holding tool
 2. Crankcase disassembling tool
 3. Crankshaft setting tool (for YG1-D, and YA6)
 4. Flywheel magneto holding tool
 5. New type exhaust ring nut wrench
 6. Hitachi armature puller (New type)
- In addition, an electro-tester, tachometer hydrometer, etc. should be provided.

Fig. 1-4-2

3. Other Tools



- | | |
|------------------------|----------------------|
| 1. Grease | 5. Overhauling stand |
| 2. Autolube oil | 6. Gear oil |
| 3. YAMAHA Bond (No. 5) | 7. Oiler |
| 4. Wiping materials | 8. Oil drain pan |

Fig. 1-4-3

Using a wooden box with a drain pan underneath will facilitate engine disassembling and servicing. Expendable parts (such as gaskets) and replacement parts must also be on hand.

Chapter 2. YAMAHA Autolube (Automatic Separate Lubricating System)

2-1 What is YAMAHA Autolube ?

Conventional 2-stroke engines are lubricated by motor oil pre-mixed in gasoline, but YAMAHA's Autolube furnishes an automatic, separate lubrication system. That is, the oil in a separate oil tank is automatically regulated by the oil pump and fed to the engine according to engine speed and load.

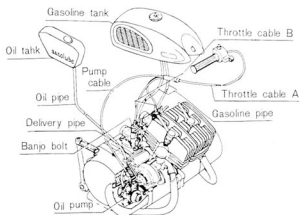

Fig. 2-1-1 YAMAHA Autolube

2-2 Features of YAMAHA Autolube

- The oil pump is driven by the engine through a reduction gear, and is connected to the carburetor throttle cable controlled by the accelerator grip.
 - The oil pump automatically regulates the volume of lubricating oil according to engine speed and the throttle valve opening, thus pumping the optimum amount of oil for engine lubrication under any operating condition.
 - This "automatic separate lubrication" does not merely eliminate disadvantages in the conventional pre-mix system, but it further improves the performance and efficiency of 2-stroke designs by eliminating certain oil-starvation conditions which formerly existed.
- 1) The Autolube feeds an optimum amount of lubricating oil to the engine under any operating condition, thus featuring:
 - Less oil consumption.
 - Less carbon accumulation.
 - Less exhaust smoke.
 - Improved lubricating efficiency.
 - 2) The Autolube simplifies fuel supply, thus featuring:
 - Straightening gasoline directly into the fuel supply.
 - Less fuel contamination.

- 3) The Autolube improves the reliability of lubrication, thus eliminating:
- Special care concerning the quality of oil and oil/fuel mixing ratio.

2-3 Handling the Oil Pump

The oil pump is a precision-machined assembly. Make no attempt to disassemble it. When removing the oil pump from the engine, protect it from dust, dirt, etc. After reinstallation, be sure to bleed and set the pump correctly. Proper handling will keep the pump free of trouble.

1. Bleeding

When the oil pump has been removed, the oil pipe disconnected, or when there is no oil in the oil tank (e. g., a brand new machine), air enters the pump case and interrupts the flow of oil, so that the pump must be bled.

- Remove the bleeder bolt and rotate the starter plate (manual feed wheel) toward you, to feed oil through the pump. Hold the adjusting pulley in to let the plunger pump at maximum stroke. As you turn the starter plate, oil begins flowing out of the bleeder hole. When air bubbles no longer appear in the oil, install and tighten the bleeder bolt. (Fig. 2-3-1)
- After the oil pump is reinstalled, a relatively large amount of oil must be fed to the engine. After setting the oil pump, start the engine to feed oil to the engine at idling speed. For one minute or so pull the pump cable and keep the pump plunger at maximum stroke.
 - ※ Observe the flow of oil in the delivery pipe. If no air bubbles appear, bleeding is complete.



Fig. 2-3-1

2. Oil Pump and Carburetor Adjustments

- 1) Start the engine and let it warm up before making sure its idling speed is between 1,100 and 1,200 r. p. m.
 - Be sure the pilot air screw on each carburetor is backed off $1\frac{1}{4}$ turns from a lightly seated position.
 - Adjust the throttle stop screw so that explosions in both cylinders take place evenly. (If a tachometer is available, use

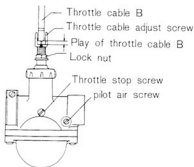

Fig. 2-3-2

- it, If not available, make judgement by exhaust sound, exhaust pressure, etc.)
- 2) Synchronise both throttle valves so that they operate simultaneously.
 - a. Remove all slack from the two throttle cables by adjusting the throttle cable adjusting screw. (See Fig. 2-3-2.)
To adjust the throttle cable, hold the throttle cable B with your fingers, and pull it up and down while turning the throttle cable adjusting screw. If the throttle cable is too tight, idling speed tends to rise. Take care not to make the throttle cable excessively-tight. Be sure that both throttle cables operate simultaneously.
 - b. Next, adjust the slack of the throttle cable A to 0.5-1.0 mm with the adjusting nut installed on the cable guide pipe. (See Fig. 2-3-3).
 - 3) After adjusting the carburetor throttle cable, set the oil pump correctly.
 - a. Slowly open the accelerator grip when the slack of the throttle cable A is removed (in this case, the accelerator grip feels tight), adjust the pump cable so that the marking on the pump adjusting pulley is aligned with the adjusting pulley guide pin. (See Fig. 2-3-4.)

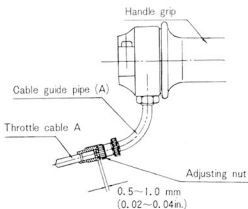

Fig. 2-3-3

3. Checking Minimum Pump Plunger Stroke

- 1) Stop the engine.
- 2) Turn the accelerator grip, so that the throttle valves are fully closed.
- 3) Turn the oil pump starter plate in the direction of the arrow marked on the plate until the plunger moves out to the end of its stroke. Then measure the narrowest gap between the adjusting pulley and the adjusting plate, with a feeler gauge.
 - a. Correction Standards

Inspection limit(min.) 0.15mm(0.006")

Correction standard 0.20-0.25mm (0.008-0.010")

If the adjusting plate-to-pulley clearance is less than the inspection limit, remove the adjusting plate and install 0.1mm(0.004in.) adjusting shims behind it to obtain the standard clearance.

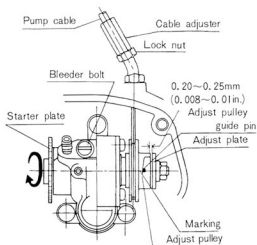

Fig. 2-3-4

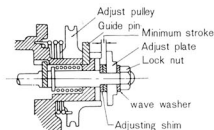

Fig. 2-3-5

Chapter 3. 5-Port Cylinder

3-1 Description of 5-Port Cylinder

As a high-efficient loop scavenging method for 2-stroke engines, the schnuerle scavenging system is widely employed throughout the world.

In this system, the transfer ports are arranged immediately right and left of the exhaust port(s). If the transfer ports are so designed that their sizes and positions, as well as the angles of the two streams of fresh charge, are very satisfactory, the schnuerle scavenging system will be better than any other loop scavenging system. The system however, has a design limit in itself; that is, the transfer ports cannot be made large enough to completely clear the combustion gas from the combustion chamber, because of their relationship with the other ports (inlet and exhaust).

As a result, part of the combustion gas remains in the upper central area of the cylinder. If such a disadvantage can be overcome, the scavenging efficiency will greatly improve, and the performance of 2-stroke engine will also be enhanced. To this end, the rotary valve engine with the third transfer ports cylinder has been developed, and can be expected to achieve higher performance than piston valve engines.

As already mentioned, the 5-port cylinder has been designed with the aim of surpassing the present limit of the scavenging system for piston valve engines. With this new design of the cylinder, the combustion gas can be completely cleared out by the streams from the new "auxiliary transfer ports", and in consequence, greater engine output can be obtained, along with higher scavenging efficiency.

The 5-port cylinder is the first of its kind and a revolutionally innovation that YAMAHA has succeeded in adopting to 2-stroke engines, following the famous rotary valve and Autolube lubricating systems.

3-2 Construction and Features (See Figs. 3-21 and 2.)

The cylinder is provided with two auxiliary transfer passages branching off the main transfer passages located above the crankcase gas-tight joint (sealing surface).

The auxiliary transfer ports are positioned almost even with the main transfer ports, and induction is deflected to the area where the combustion gas otherwise tends to remain.

As the high pressure of the burnt gas moves the piston downward, the fresh charge of gas rushes into the cylinder, forming a loop stream (a), and clearing the burnt gas out into the exhaust port. At the same time, the air/fuel mixture rushes into the cylinder from the auxiliary transfer ports forming additional loop streams (c) to clear out the remaining burnt gas in the upper central area of the cylinder.

These auxiliary transfer ports play the same role as the third transfer port in the rotary valve engine. As a result, the 5-port system can compare favorably with the conventional rotary valve system, assuring high-performance both at low and at high engine speeds.

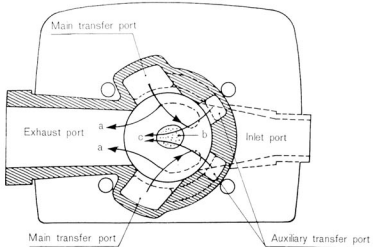

Fig. 3-2-1

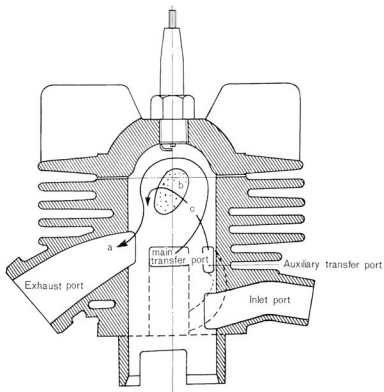

Fig. 3-2-2

3-3 Performance Comparison

The results of a comparison of the 5-port cylinder and a conventional 3-port cylinder by using the AS₁(C) are given in Fig. 3-3-1.

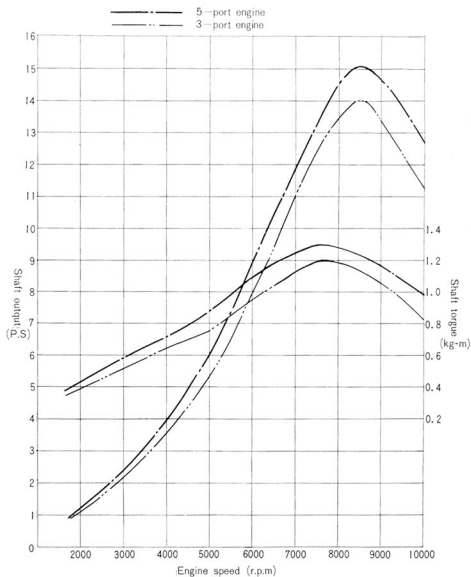

Fig. 3-3-1

Chapter 4. Engine

The engine should be disassembled and reassembled in an orderly sequence to make the work easier and more efficient. The procedures outlined here are examples, not inflexible rules for all repair jobs.

○ Caution on Disassembling the Engine

- 1) Before removing the engine, clean dirt and dust from the cylinder heads, cylinders and crankcase, to keep these parts clean inside during disassembly.
- 2) Always use clean tools and use them correctly to avoid damaging parts.
- 3) Keep disassembled parts on the parts trays in separate groups or sub-assemblies.

4-1 Removing the Engine

1. Drain the transmission oil after warming up the engine for one minute or so. (Fig. 4-1-1)

Volume of oil: 800cc (SAE 10W/30)

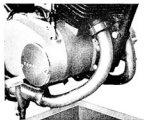

Fig. 4-1-1

2. Remove the mufflers and exhaust pipes (right and left) from both cylinders. (Fig. 4-1-2)



Fig. 4-1-2

3. Remove the foot-rest, change pedal (foot gear change), and crankcase cover (L). (Fig. 4-1-3)



Fig. 4-1-3

4. Remove the A. C. dynamo. (Disconnect the wire harness from the A. C. dynamo.)

1) Remove the cam. (Fig. 4-1-4)



Fig. 4-1-4

2) Remove the stator assembly. (Fig. 4-1-5)

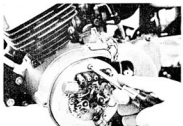

Fig. 4-1-5

3) Remove the rotor with the rotor removing bolt (Hitach M8, P1.25). (Fig. 4-1-6)

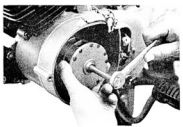

Fig. 4-1-6

5. Remove the air cleaner assembly.
(Fig. 4-1-7)

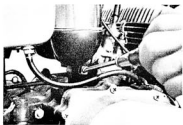

Fig. 4-1-7

6. Remove the carburetor throttle valve. (Fig. 4-1-8)

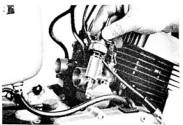

Fig. 4-1-8

-
7. Remove the crankcase cover (L).

(Fig. 4-1-9)

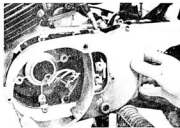

Fig. 4-1-9

8. Disconnect the neutral light lead.

(Fig. 4-1-10)



Fig. 4-1-10

9. Remove the carburetor.

10. Remove the chain. (Fig. 4-1-11)

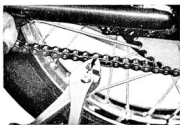

Fig. 4-1-11

11. Disconnect the oil pipe at the bottom of the oil tank. (Fig. 4-1-12)

Be sure to plug the hole to prevent oil from flowing out.

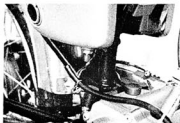

Fig. 4-1-12

12. Remove the oil pump cable. (Fig. 4-1-13)



Fig. 4-1-13

13. Remove the engine mounting bolts, and de-mount the engine from the frame. (Fig. 4-1-14)

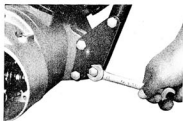

Fig. 4-1-14

4-2 Cylinder Head

1. Removal and Reinstallation

Remove the nuts from the four cylinder stud bolts, and remove the cylinder head and gaskets. Reverse the order in order to reinstall the head. (Fig. 4-2-1)

Replace any damaged cylinder head gasket.

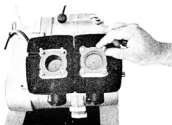

Fig. 4-2-1

2. Removing Carbon

Carbon accumulations inside the cylinder head (combustion chamber) increase the compression ratio, causing preignition, overheating, and increased fuel consumption. Check for carbon accumulations, and remove them.

(Fig. 4-2-2)

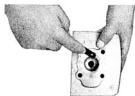

Fig. 4-2-2

4-3 Cylinder

1. Removing the Cylinder

Remove the cylinder by tapping the cylinder fin with a plastic tip hammer, as shown in Fig. 4-3-1.



Fig. 4-3-1

2. Checking Cylinder Wear

Measure each cylinder bore diameter at four different depths with a bore measuring micrometer or a cylinder gauge placed parallel to, then at right angles to the crankshaft, for 8 measurements in each cylinder. If the difference between the maximum and minimum diameters measured exceeds 0.05mm, hone the cylinder. (Figs. 4-3-2 and 3)

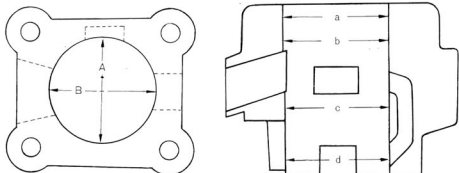

Fig. 4-3-2

- 1) Minimum clearance between the piston and cylinder should be 0.040-0.045 mm. (0.0016-0.0018")

Notes on Cylinder Reconditioning:

To recondition the cylinder, follow the following steps.

- a. Pistons are available in 0.25 mm and 0.50 mm oversizes.
- b. Cylinders should be bored and honed to the diameter of the oversize piston plus piston-to-cylinder clearance.
- c. The deviation between the maximum and minimum bore diameters after honing should be no more than 0.01mm. (0.0004")



Fig. 4-3-3

3. Installing Cylinders

- 1) Always use new cylinder base gaskets when overhauling the engine. (Fig. 4-3-4)

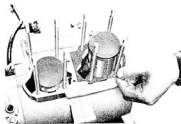

Fig. 4-3-4

- 2) When installing the cylinder over the piston, squeeze the piston rings into their grooves (their end gaps should close on the locating pins) so that the rings will not catch and break on the bottom of the cylinder. (Fig. 4-3-5)



Fig. 4-3-5

4. Removing Carbon

Carbon tends to accumulate heavily on the walls of the cylinder exhaust ports. Scrape the carbon off with a screwdriver. (Fig. 4-3-6)



Fig. 4-3-6

4-4 Piston Pin

1. Removing the Piston Pin

Remove the clip at both ends of the piston pin with needle nose pliers, and push the pin out from the other side of the piston with a screwdriver. (Fig. 4-4-1)

Note: Before removing the piston pin clips cover the crankcase opening with a clean rag to prevent a clip from dropping into the crankcase.



Fig. 4-4-1

2. Fitting the Piston Pin in the Piston

The piston pin should fit snugly in its hole so that it drags a little as it is pressed.

If the pin is loose, the pin and/or the piston should be replaced. A pin with step-wear in its center should be replaced, together with the conrod small end needle bearing.

(Fig. 4-4-2)



Fig. 4-4-2

4-5 Piston Ring

1. Removing the Piston Rings

Put your thumbs on each end of the piston ring and pull the piston ring ends apart, then ease the ring out of its groove on the opposite side from the ends. (Figs. 4-5-1 and 2)



Fig. 4-5-2



Fig. 4-5-1

2. Fitting the Rings

First fit the No. 2 ring (parkerized) over the piston, and then the No. 1 (chrome), and align their end gaps with the locating pin in each ring groove. (Fig. 4-5-3)

The printing on all rings must face up to position the gap properly at the pin.

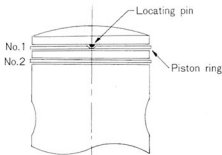

Fig. IV-5-3

3. Checking the Piston Rings

1) Measuring Piston Ring Wear

Put each ring into the cylinder so that the ring is parallel to the cylinder bottom edge, and then measure the end gap with a feeler gauge. (Fig. 4-5-4)

The end gap should be between 0.15 and 0.45 mm (0.006-0.018") for both No. 1 and No. 2 rings.



Fig. 4-5-4

2) Removing Carbon.

Carbon on the piston rings and in the ring grooves will make the rings stick in the piston, thus causing gas blow-by.

Remove the rings from the piston, and clean the carbon from the rings and ring grooves.

Note: Clearance between the ring and the ring groove: (Fig. 4-5-5)

No. 1 ring (Upper).....0.03-0.07mm
(0.0012-0.0028")

No. 2 ring (Lower).....0.03-0.07mm
(0.0012-0.0028")

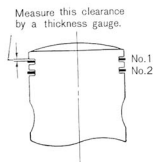

Fig. 4-5-5

4-6 Piston

1. Checking and Correcting the Piston

1) Measuring Piston Clearance

Piston clearance is the difference between the minimum cylinder bore diameter and the maximum outside diameter of the piston.

As described in 4-3 Cylinder before piston clearance should be 0.040 and 0.045 mm. (0.0016-0.0018")

To determine the maximum piston diameter, measure the piston with a micrometer at right angles to the skirt 10 mm from its bottom edge. (Fig. 4-6-1)



Fig. 4-6-1

2) Checking and Correcting Scratches on the Piston

Pistons showing signs of seizure will result in noise and loss of engine power. It will also cause damage to the cylinder wall. If a piston that has seized is used

again without correction, another seizure will develop at the same area. Lightly sand the seizure "high spot" on the piston with #400 sandpaper.

(Figs. 4-6-2 and 3)



Fig. 4-6-2



Fig. 4-6-3

3) Removing Carbon

Remove carbon accumulations on the piston head, with a screwdriver or a saw blade. (Fig. 4-6-4)

Carbon accumulations in the piston groove will result in piston ring seizure. Remove them from the ring groove. (Fig. 4-6-5)



Fig. 4-6-4



Fig. 4-6-5

2. Piston Installation Direction

Install the piston with the arrow mark on the head pointing downward (toward the exhaust port of the cylinder). (Fig. 4-6-6)

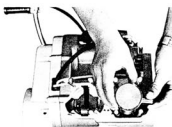

Fig. 4-6-6

4-7 Crankcase Cover (R)

1. Removal

- 1) Remove the kick-starter crank clamping bolt, and remove the crank. (Fig. 4-7-1)

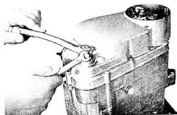

Fig. 4-7-1

- 2) Remove the pan-head screws from the crankcase cover (R), and take off the cover. (Fig. 4-7-2 and 3)

(The crankcase cover may be removed together with oil pump left in place.)



Fig. 4-7-2

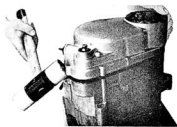

Fig. 4-7-3

- 3) Replace the crankcase cover gasket, if damaged. (Fig. 4-7-4)



Fig. 4-7-4

2. Reinstallation

Apply YAMAHA BOND No.5 to the sealing surface of the crankcase (R), install the crankcase cover gasket over it, and then install the crankcase cover (R). (Fig. 4-7-5)
Note: Be sure to apply YAMAHA BOND No. 5 to the crankcase sealing surface, otherwise, oil leakage will result.



Fig. 4-7-5

4-8 Clutch

The clutch is of the wet multiple-disc type, consisting of five moulded fiber friction plates and five steel clutch plates, and mounted on the transmission main shaft.

The housing is integrated with the large reduction gear, which is driven by the small reduction gear (primary drive gear.) The primary drive gear has 19 teeth and the primary driven gear 74, thus making the primary drive reduction ratio 3.894:1. The pushing-mechanism has been changed from the screw type to the lever operation type.

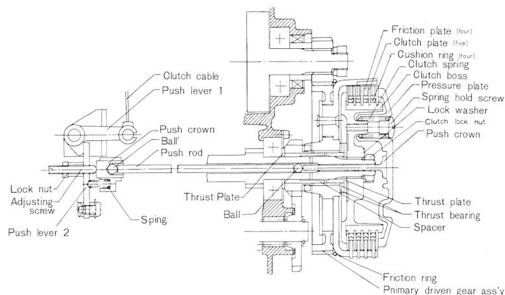

Fig. 4-8-1 Clutch Cross Section

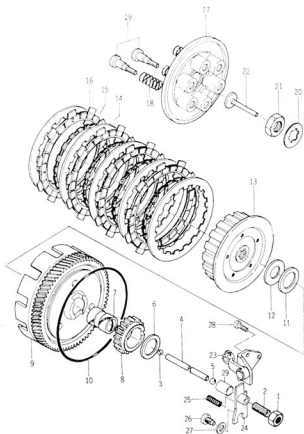

Fig. 4-8-2 Layout of Clutch Assembly

- | | |
|---------------------------------|-----------------------------|
| 1. Lock nut | 16. Friction plate |
| 2. Adjusting screw | 17. Pressure plate |
| 3. Ball | 18. Clutch spring |
| 4. Push rod | 19. Spring hold screw |
| 5. Ball | 20. Look washer |
| 6. Thrust plate | 21. Look nut |
| 7. Spacer | 22. Push crown |
| 8. Kick pinion gear | 23. Push lever assembly (1) |
| 9. Primary driven gear assembly | 24. Push lever assembly (2) |
| 10. Friction ring | 25. Return spring |
| 11. Thrust bearing | 26. Pan-head screw |
| 12. Thrust plate | 27. Washer |
| 13. Clutch boss | 28. Pan-head screw |
| 14. Clutch plate | 29. Push crown |
| 15. Cushion ring | |

1. Removing the Pressure Plate

Remove the five clutch spring screws, and remove the springs and pressure plate.
(Fig. 4-8-3)

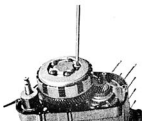

Fig. 4-8-3

2. Checking Clutch Springs

Measure the free length of each clutch spring, and replace any spring more than 1.0 mm (0.04 in.) shorter than the standard free length. (Figs. 4-8-4 and 5)

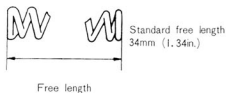

Fig. 4-8-4

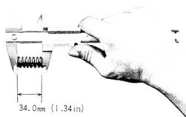

Fig. 4-8-5

3. Checking Friction Plates

Friction plates are designed to wear. Replace plates worn more than 0.3mm or showing uneven contact with the clutch plates. (Figs. 4-8-6 and 7)

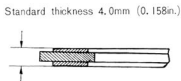

Fig. 4-8-6



Fig. 4-8-7

4. Installing Cushion Rings

The cushion rings are installed between the clutch boss and the friction plate to insure even engagement and complete disengagement of the plates.

When fitting cushion rings, be sure they are flat and not twisted. (Fig. 4-8-8)



Fig. 4-8-8

5. Removing the Clutch Boss

Pull out the push rod A, and straighten the bent edge of the clutch boss locking washer. Fit the YA6 clutch holding tool over the clutch boss, remove the nut, and then remove the boss. (Figs. 4-8-9 and 10)

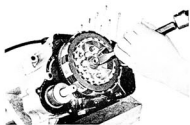

Fig. 4-8-9



Fig. 4-8-10

6. Clutch Housing Assembly (Integral with the primary driven gear)

1) Checking

Insert the spacer in the primary driven gear boss, and check it for radial play and scratches.

Any spacer with scratches on it will impair clutch action. Smooth out the scratched surface with an oil stone or very fine grain sandpaper. If the play is excessive, it will result in noise. Replace the spacer. (Fig. 4-8-11)



Fig. 4-8-11

7. Checking the Spacer

Install the spacer on the main axle, and check it for play. If play exists, replace the spacer. (Fig. 4-8-12)



Fig. 4-8-12

8. Checking the Push Rod

Remove the push-rod from the clutch boss and roll it over a surface plate. If the rod is bent, straighten or replace it. (Fig. 4-8-13)



Fig. 4-8-13

9. Note on Reassembling the Clutch

On both ends of the spacer are installed a washer and thrust bearing. If the washer and thrust bearing are incorrectly fitted or either of them is omitted, the clutch boss will ride against the primary driven gear and prevent smooth clutching. Be sure that the washer and thrust bearing are correctly installed when reassembling the clutch. (Figs. 4-8-1 and 2)

The thrust bearing is placed around the spacer. When installing the clutch boss, take care so that the thrust bearing will not slip off the spacer. Before installing the clutch boss, grease both faces of the thrust bearing to make the installation work easy.

10. Clutch Adjustment

Clutch components, such as friction plates, clutch plates, etc. will wear after being used for a long time. Such wear will result in clutch slippage or other clutch malfunctions. Replace or correct worn clutch components.

How to adjust the clutch cable:

Adjust the clutch cable and determine the position of the cam (push lever). Then turn in the adjusting screw, and adjust clutch lever play.

How to determine the cam position:

- 1) Remove the dynamo cover. (Fig. 4-8-15)
- 2) As shown in Fig. 4-8-14, a marking line is stamped on both cam (push lever) and lever holding plate. Adjust the length of the clutch cable so that both marking lines are aligned.

The gap between the two marking lines must be within 1 mm. (0.04 in.)

In this case, the marking line on the cam (push lever) should not be above that of the lever holding plate. For this adjustment, use the cable adjusting screw as shown in Fig. 4-8-16.

- 3) After determining the cam position (or length of the cable), adjust clutch lever play (Fig. 4-8-16) to 2-3 mm ($\frac{1}{16}$ ~ $\frac{1}{8}$ in.) by turning the adjusting screw (Fig. 4-8-14) in or out.

Note: Be sure that both marking lines are aligned correctly, otherwise, the correct push stroke can not be obtained, thereby impairing clutch action or gear shifting.

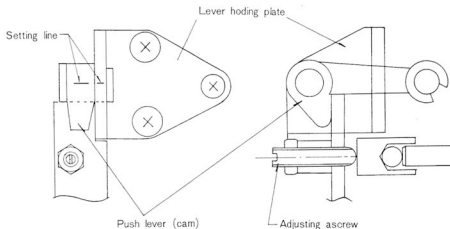

Fig. 4-8-14

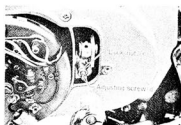

Fig. 4-8-15

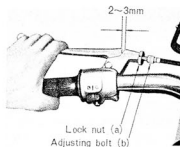

Fig. 4-8-16

4-9 Primary Drive Gear

1. Removal

- 1) Feed a rolled up rag between the teeth of the primary drive gear and primary driven gear to lock them, and then loosen the lock nut. (Fig. 4-9-1)
- 2) To remove the gear, use a slot-head screwdriver as indicated in The gear can easily be removed.

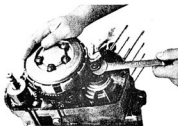

Fig. 4-9-1

2. Inspection

Excessive gear backlash will result in clashing noises, while an insufficient gear backlash will cause a whine. To measure gear backlash, a dial gauge or a special gauge is required.

For convenience of selecting a proper combination of the primary drive gear and the primary driven gear, a number is stamped on each gear face. When installing gears, select those that will give a proper combination.

Standard Value:

- | | |
|------------------------|-------|
| a. Total of numbers | 150±1 |
| b. Primary drive gear | 83~86 |
| c. Primary driven gear | 64~67 |

Check gears for scratches, wear and gear-to-shaft fitting. Replace any worn gear. If gears cause clashing or whining replace the gears. To eliminate clashing noise, increase the total of the numbers as shown in a., while to eliminate whining, reduce the total of the numbers.

4-10 Distance Collars

Distance collars can be pulled out with your fingers or with pliers.

When reinstalling distance collars, apply grease to the oil seal lip groove.

Take care not to install the distance collar with the wrong side facing toward the oil seal lip. It will damage the oil seal. (The larger chamfered side must be on the side of the oil seal.

4-11 Kick-starter

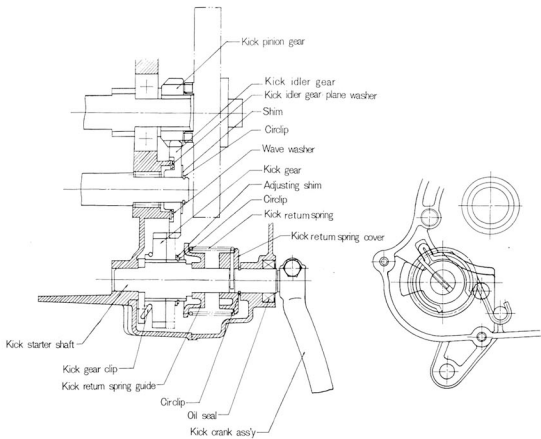

Fig. 4-11-1

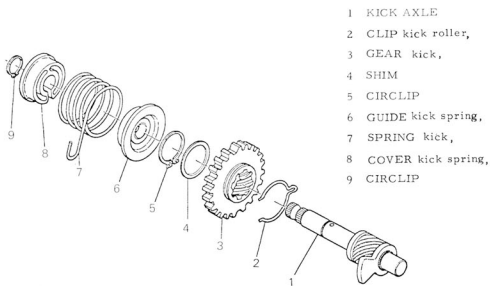

Fig. 4-11-2

Kick-starter Mechanism:

The primary kick-starter system (one-touch kick-starter) is employed. However, a new "non-constant-mesh" mechanism has been introduced into the YAS1, YASIC kick-starter, replacing the constant-mesh kick gear type, such as the ratchet and roller-rock systems.

That is, the kick gear meshes with the idler gear only when the kick starter pedal is kicked. After the engine is started, the kick gear is disengaged from the idler gear. This mechanism not only eliminates noise resulting from the constant mesh of the kick gear with the idler gear, but also greatly contributes to the durability of the kick-starter assembly.

4-12 Drive Sprocket

1. Removal

- 1) Straighten the bent edge of the lock washer with a screwdriver or with a chisel.
(Fig. 4-12-1)

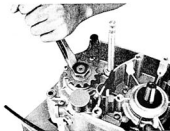

Fig. 4-12-1

- 2) Keep the drive sprocket from turning, with the flywheel magneto holding tool, and remove the sprocket nut. (Fig. 4-12-2)

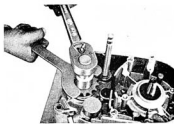

Fig. 4-12-2

If the flywheel magneto holding tool is not available, shift the transmission to low gear, and fit a socket wrench on the sprocket nut. Then tap the handle of the wrench with a hammer, and the shock will loosen the nut.

2. Checking the Drive Sprocket

Worn drive sprocket will result in excessive chain noise, and shorten the life of the chain. Check the sprocket for worn teeth, and replace if they are worn.
(Fig. 4-12-3)

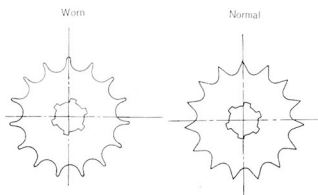

Fig. 4-12-3

4-13 Shifting Mechanism

Construction and Operation:

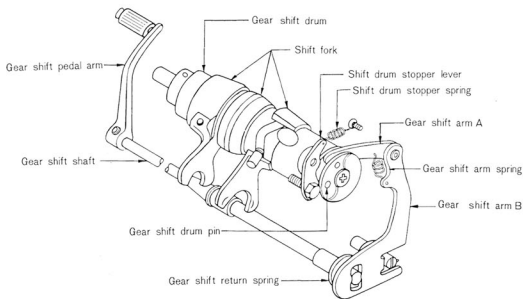

Fig. 4-13-1 Shifting Mechanism

As the gear shift pedal is depressed, the gear shift arm A is moved back and forth by the gear shift arm B. The gear shift drum pin is pressed by the gear shift arm A, thus turning the gear shift drum.

Five gear shift drum pins are provided. Therefore, as the gear shift pedal is pulled down, the gear shift drum makes a $1/5$ turn. In other words, a full turn of the shift drum provides five shifts, first, second, third, fourth, and fifth.

The shift drum stopper lever is designed to press against the gear shift drum pins by means of a disc plate, thus keeping the shift drum correctly on each shifting position.

The gear shift drum is provided with grooves on its outer surface, and the shift forks move laterally in the grooves to shift the gear.

The shift drum's neutral position is located between the low and second gear shift drum pins. The stopper mechanism is incorporated on the left side of the shift drum. The gear shift pedal is of a seesaw type.

1. Removing the Gear Shift Assembly

Remove the circlip and washer from the gear shift shaft on the left side of the engine, and pull the gear shift arm A from the right side of the engine while pushing the arm upward. (Figs. 4-13-2 and 3)

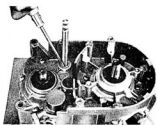

Fig. 4-13-2

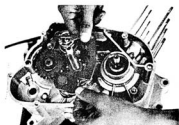

Fig. 4-13-3

2. Checking the Gear Shift Parts (Fig. 4-13-4)

1) Checking the Gear Shift Return Spring.

A broken or fatigued gear shift return spring will impair the return action of the shifting mechanism.



Fig. 4-13-4

2) A fatigued or broken gear shift arm spring will impair shifting action. Check it, and replace if it is faulty.

3. Gear Shift Arms

- 1) Remove the mounting bolt, and remove the gear shift arm, together with the spring. (Fig. 4-13-5)

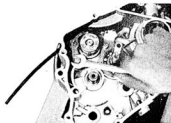

Fig. 4-13-5

- 2) Checking the Gear Shift Arm Spring (Fig. 4-13-1)

Check for a fatigued or broken gear shift arm spring. A faulty gear shift arm may result in an improper shifting sequence.

4. Adjusting the Gear Shift Arm

To Adjust or correct the travel of the gear shift arm to prevent improper shifting progression (excess feed or insufficient feed of the gear shift arm), by turning the gear shift return spring stop screw (eccentric bolt) in or out. (Fig. 4-13-6)

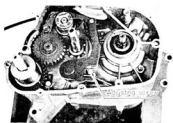

Fig. 4-13-6

4-14 Splitting the Crankcase

1. Dividing

The crankcase can be divided from either the left or the right side. However, to facilitate the subsequent work, start splitting the crankcase from the right half.

- 1) Remove the pan head screws from the left crankcase. (Fig. 4-14-1)

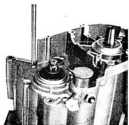

Fig. 4-14-1

- 2) Install the crankcase dividing tool on the right crankcase. Divide the crankcase while tapping the main shaft and the crankcase alternately, with plastic tip hammer. (Figs. 4-14-2 and 3)

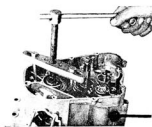

Fig. 4-14-2

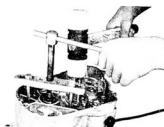

Fig. 4-14-3

Note:

1. Fully tighten the bolts of the crankcase diving tool, and keep the tool in a horizontal position.
2. Bring the nearest piston up to top dead center, so that the connecting rod will not contact the crankcase. Insert some sort of thrust bearing between the end of the crankshaft and the center bolt of the dividing tool to keep the crankshaft from turning so that the connecting rod will stay at top dead center.

2. Reassembling

When reassembling the crankcase, be sure to apply YAMAHA BOND No.5 to the mating surfaces of both halves. (Fig. 4-14-4)



Fig. 4-14-4

4-15 Transmission Assembly

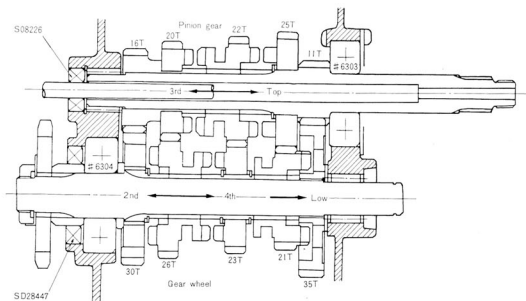

Fig. 4-15-1 Layout of Transmission Gears

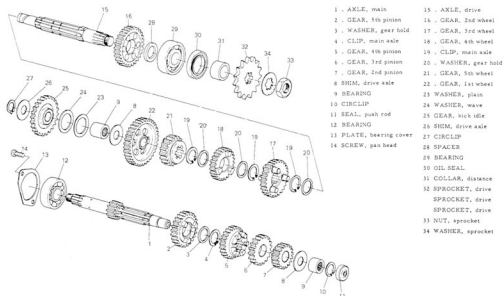

Fig. 4-15-2 Component Parts of Transmission Gears

For layout of the transmission and related parts, refer to Figs. 4-15-1 and 2.

The primary reduction ratio is $74/19=3.894$, and the secondary reduction ratio is $39/15=2.600$

	Primary reduction ratio	Transmission gear reduction	Secondary reduction	Total reduction ratio
1st	3.894 (74/19)	3.182 (35/11)	2.600 (39/15)	32.215
2nd	" (")	1.875 (30/16)	" (")	18.983
3rd	" (")	1.300 (26/20)	" (")	13.161
4th	" (")	1.045 (23/22)	" (")	10.580
5th	" (")	0.840 (21/25)	" (")	8.504

1. Removal

- 1) Remove the clip, holder and washer from the gear shift drum on the left side of the engine. (Figs. 4-15-3 and 4)

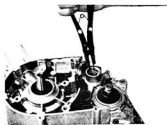

Fig. 4-15-3



Fig. 4-15-4

- 2) Remove the neutral stopper mechanism. (Figs. 4-15-5 and 6)

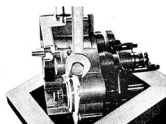

Fig. 4-15-5

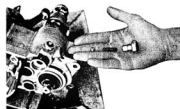

Fig. 4-15-6

-
- 3) Remove the transmission and shifter as a unit. (Fig. 4-15-7)

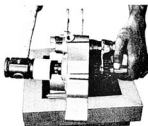

Fig. 4-15-7

2. Caution on Assembling the Transmission

- 1) Reinstalling the Transmission and Shifter as a Unit

Reinstall the transmission and shifter as a unit in the left crankcase half after they are sub-assembled. They can not be installed separately. (Fig. 4-15-8)



Fig. 4-15-8

- 2) Caution on Assembling Crankcase (To prevent the shift fork from bending)
- Shift the transmission to low and position all parts, then put the crankcase halves together. Be sure that the dogs are correctly engaged with one another at low gear when putting the crankcase halves together.
Set the cam drum in low gear, and do not allow it to turn.
 - Avoid putting the crankcase halves together with the transmission in top gear (5th speed).
Otherwise, both dog teeth are pushed against each other without engaging, and when the crankcase halves are put together, the shift fork will be bent.

4-16 Crankshaft

Of all the engine parts, the crankshaft requires the highest degree of accuracy in engineering and servicing. Nevertheless, the crankshaft is most liable to wear, and therefore, it must be handled with special care.

The crankshaft center oil seal in the YAMAHA 125 YAS1 (YAS1C) employs an aluminum, labyrinth type packing, which is outstanding in resistance to oil, heat and friction.

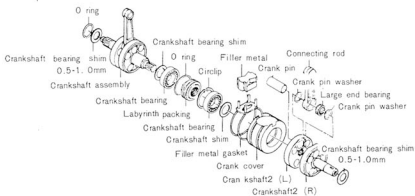

Fig. 4-16-1 Crankshaft Assembly Component Parts

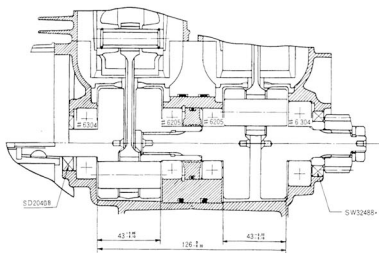

Fig. 4-16-2 Dimensions of Engine

1. Removing the Crankshaft Assembly

- 1) Remove the crankshaft assembly by the use of the crankcase dividing tool.
(Fig. 4-16-3)



Fig. 4-16-3

Note:

- 1) Fully tighten the bolts of the crankcase dividing tool, and keep the tool in a horizontal position.
- 2) Bring the piston up to top dead center, so that the connecting rod will not contact the crankcase. Insert some sort of thrust bearing between the end of the crankshaft and the center bolt of the dividing tool to keep the connecting rod at top dead center.

2. Disassembling the Crankshaft Assembly

Disassembling the crankshaft assembly requires a special tool as shown in Fig. 4-16-4. The disassembling work is carried out as in the cases of YD and YDS series. The special tool is of the same type as used for the YL1.

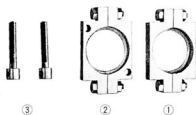

Fig. 4-16-4

- 1) Insert the halves into the space between the crankshaft web and the crank cover, (Fig. 4-16-5)



Fig. 4-16-5

- 2) Tighten the pieces of the tool together with bolts, (Fig. 4-16-6)

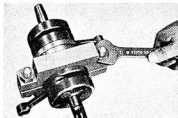

Fig. 4-16-6

- 3) Fig. 4-16-7 shows the complete installation of the tool in the crankshaft.
(Fig. 4-16-7)

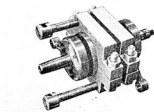

Fig. 4-16-7

- 4) Hold the above assembly in a vice. Turn each bolt of the tool one turn alternately, (Fig. 4-16-8) and continue turning the bolt until the crankshaft assembly splits into two halves.



Fig. 4-16-8

- 5) Fig. 4-16-9 shows the disassembled crankshaft.

Remove the crank cover and bearing, by using a hand press. (Fig. 4-16-9)

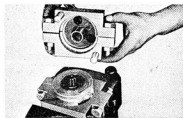

Fig. 4-16-9

- 6) Fig. 4-16-10 shows how to remove the crank pin.
(Use the jigs as indicated in Fig. 4-16-11.)



Fig. 4-16-10

3. Assembling the Crankshaft

To assemble the crankshaft, use a set of special jigs as shown in Fig. 4-16-11.

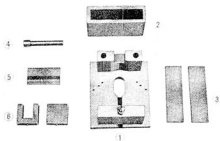

Fig. 4-16-11

1) Install the tool for controlling the width of the assembled crank (6) in the main jig as shown in Fig. 4-16-12.



Fig. 4-16-12

2) Press the crank pin into one half of the crankshaft, install the crankshaft in the main jig (1), and install the connecting rod on the crankshaft. (Fig. 4-16-13)

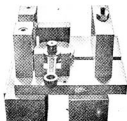

Fig. 4-16-13

3) Join the other half of the crankshaft with the above crankshaft, and press the crank pin into the crankshaft end only half way in. Then place the slide plate on the rim of the crank web, and align the crankshaft temporarily. (Fig. 4-16-14)

Note: When striking the slide plate with a hammer, temporarily tighten the lock nut.

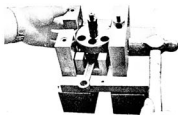

Fig. 4-16-14

- 4) Fully tighten the lock nut.

(Fig. 4-16-15)



Fig. 4-16-15

- 5) Place the tool for press (2) on the crank web, and press the crank downward, with a hand press, until the tool (2) contacts the tool (6). The final press load on the crank is 5-8 tons. (Fig. 4-16-16)

The press must be positioned in the center line of the crank pin. (Fig. 4-16-17)

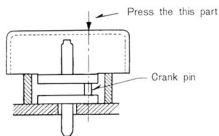

Fig. 4-16-17

- 6) After assembling each crankshaft half, start assembling the whole crankshaft assembly.

Press the crank cover over one of the cranks with a press, and then install the other half of the crankshaft assembly on the above crankshaft assembly by the use of a press.

During this operation, place the supporting plate (5) into the space between the cranks in order to prevent the crankshaft from going out of alignment. (Fig. 4-16-18)

Then align the whole crankshaft assembly.

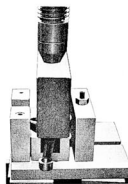

Fig. 4-16-16



Fig. 4-16-18

4. Aligning the Crankshaft

- 1) To inspect the alignment of the crankshaft, place it between centers or on V blocks. (Figs. 4-16-19)
- If the crankshaft is misaligned more than the allowable tolerances, adjust it.

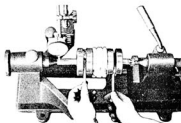

Fig. 4-16-19

- 2) To align the crankshaft, install a wedge between the webs or tap the crank web with a brass hammer. (Figs. 4-16-20 and 21)



Fig. 4-16-20



Fig. 4-16-21

5. Accuracy of the Crankshaft Assembly

- As shown in Fig. 4-16-22, pinch the connecting rod small end with your fingers and check the axial play of the small end for wear of both big end crank pin and bearing.

Standard Value:

- 1) Movement by dial gauge reading must be less than 2 mm. If the reading shows more than 2 mm, disassemble the crankshaft and replace any worn parts.
- 2) Axial play after correction must be 0.8-1.0mm.

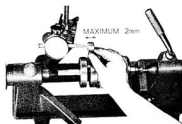

Fig. 4-16-22

- Check the axial play at the connecting rod big end, with a feeler gauge.

When measuring the play, lightly pry the connecting rod sideways. (Fig. 4-16-23)

Standard Value: 0.1-0.3mm



Fig. 4-16-23

- Check the width of the cranks and runout of the crankshaft assembly. (Fig. 4-16-24)

Standard Value:

$$A \dots\dots 43 \begin{matrix} -0.05 \\ -0.10 \end{matrix}$$

$$B \dots\dots 126 \begin{matrix} -0 \\ -0.20 \end{matrix}$$

Runout 0.05 mm or less

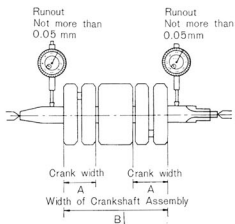

Fig. 4-16-24

6. Reinstalling the Crankshaft Ass'y

Put shims on both ends of the crankshaft, and install the crankshaft assembly by using the crankshaft setting tool. (same tool as used for YA-6)

Hold the connecting rod at top dead center with one hand while turning the handle of the setting tool with the other. (Fig. 4-16-25)

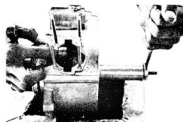

Fig. 4-16-25

4-17 Bearings and Oil Seals

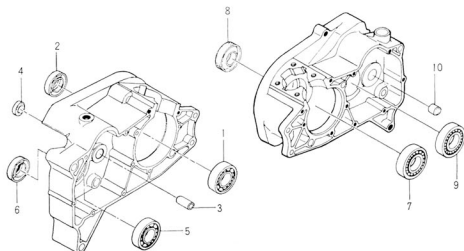

Fig. 4-17-1 Installation Position of Bearings and Oil Seals

1. Bearing (#6304)
2. Oil seal (SD20408)
3. Needle bearing
4. Oil seal (SD08226)
5. Bearing (#6304)
6. Oil seal (SD28447)
7. Bearing (#6304)
8. Oil seal (SW28408)
9. Bearing (#6303)
10. Needle bearing (same as 3.)

1. Removal and Reinstallation

Ideally, the crankcase should be heated to approximately 120°C (248°F) to easily remove or install oil seals and bearings, but the following steps may be allowed.

1) Removal

- a. Pry the oil seals out of place with a slot-head screwdriver. (Fig. 4-17-2)

Whenever the engine is overhauled, replace the oil seals.

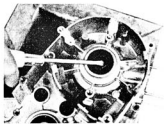

Fig. 4-17-2

- b. Remove the bearings with the bearing removing tool. (Fig. 4-17-3)



Fig. 4-17-3

c. Reinstallation

Install all bearings and oil seals with the maker's mark or numeral stamped facing upward.

Pack all bearings with an adequate amount of grease before installation.

4-18 Carburetor

The YAMAHA 125YAS1's (YAS1C) engine is equipped with a pair of Mikuni-made Amal VM17SC carburetors.

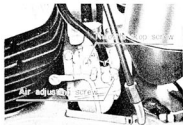
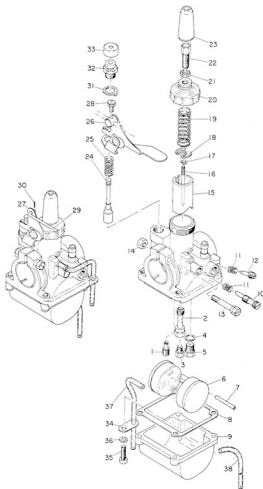

Fig. 4-18-1

- 1 . JET, pilot
- 2 . NOZZLE, main
- 3 . JET, main
 - . JET, main
 - . JET, main
 - . JET, main
 - . JET, main
- 4 . WASHER, valve
- 5 . VALVE SEAT ASS'Y
- 6 . FLOAT
- 7 . PIN, float
- 8 . GASKET, float chamber
- 9 . BODY, float chamber
- 10 . SCREW, throttle
- 11 . SPRING, air adjusting
- 12 . SCREW, air adjusting
- 13 . SCREW, body fitting
- 14 . NUT, holding
- 15 . VALVE, throttle (L.H)
 - . VALVE, throttle (R.H)
- 16 . NEEDLE
- 17 . CLIP
- 18 . SEAT, spring
- 19 . SPRING, throttle valve
- 20 . TOP, mixing chamber
- 21 . NUT, wire adjusting
- 22 . SCREW, wire adjusting
- 23 . CAP
- 24 . PLUNGER, starter
- 25 . SPRING, plunger
- 26 . LEVER, starter (L.H)
- 27 . LEVER, starter (R.H)
- 28 . SCREW, rod
- 29 . ROD, starter lever
- 30 . PIN, cotter
- 31 . PLATE, starter lever
- 32 . CAP, plunger
- 33 . COVER, plunger cap
- 34 . PLATE
- 35 . SCREW, pan head
- 36 . WASHER, spring
- 37 . PIPE, air vent
- 38 . PIPE, overflow



1. Checking the Carburetor

1) Float

If fuel leaks into the float, the float chamber fuel level will rise and make the combustion mixture too rich. Shake the float so that you may feel or hear any gasoline inside. Replace the float if it is deformed.

2) Float Valve

Replace the float valve if its seating end is worn or scratched. Check the float valve spring for fatigue. Depress the float valve with your fingers, and make sure it properly seats against the valve seat when released. If the float valve spring is weakened, the fuel may overflow, flooding the float chamber while the machine is running at a certain speed or under certain road condition.

3) Overflowing

If fuel overflows, check the carburetor in the manner as described in 1) and 2) above. If neither 1) or 2) cures the overflowing, it may be caused by dirt in the fuel, preventing the float valve from seating properly. In this case, remove the dirt from the fuel, and blow through the fuel passage.

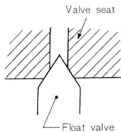

Fig. 4-18-3

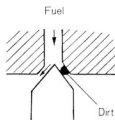

Fig. 4-18-4

4) Cleaning the Carburetor

Disassemble the carburetor, and wash all parts in clean solvent. Blow through all air and fuel passages in the carburetor with compressed air.

All jets and other delicate parts should be cleaned by blowing compressed air through them. In case that a thin wire has to be used to remove dirt, take special care not to damage parts. (Fig. 4-18-5)



Fig. 4-18-5

2. Adjusting the Fuel Level

The oil level is checked by YAMAHA before delivery, but it may fluctuate due to a worn needle valve or deformed float arm. The higher the fuel level, the richer the air-fuel mixture. The lower the fuel level, the leaner the mixture. If the fuel level is not proper, adjust it in the following manner.

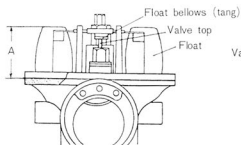

Fig. 4-18-6

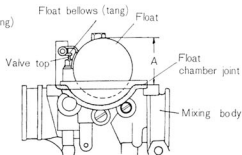

Fig. 4-18-7

- 1) Remove the float chamber body, and turn over the mixing body. Slowly push the float downward, with your finger, and when the float tang comes to contact with the upper end of the needle valve, stop and set the float.
- 2) Then measure the distance "A" from the float top to the float chamber joint surface.

Standard measurement of A: 22.5mm.

- 3) When the A distance measured is less than the standard, bend the tang out. If it is greater, bend the tang in.

3. Idle-speed adjustments

Before starting idle-speed adjustment, be sure to warm up the engine.

- 1) Start the engine.
- 2) Turn both adjusting screws (throttle stop screws) in, and slightly increase engine speed.

Note: Be sure to synchronize the carburetor slides. (Use a tachometer.)

- 3) To increase the engine speed, back out the pilot air screw slowly. When the engine speed is raised to maximum, set the pilot air screw.
(Perform this operation on both carburetors.)
- 4) Back out the throttle stop screw to decrease the engine speed. Turn the pilot air screw in or out, and set it when the engine speed is at maximum. Repeat this operation twice or so, and the correct idling speed can be obtained.

4. Carburetor Setting

Model	YAS1	YAS1C
1. M.J. (Main jet)	290	295
2. N.J. (Needle jet)	0-0	0-0
3. J.N. (Jet needle setting- the step where J.N. clip is fitted.)	4D9-4	4D9-4
4. C.A. (Throttle valve cutaway)	2.0	2.0
5. P.J. (Pilot jet)	217.5	217.5
6. A.S. (Air screw setting- the number of turns the A.S. is backed off)	1 $\frac{3}{4}$	1 $\frac{3}{4}$
7. G.S. (Starter jet)	230	230
8. Idling speed	1,100-1,200r. p.m	1,100-1,200r. p.m

4-19 Air Cleaner

1. Removal

- 1) Remove the side covers on both right and left.
- 2) Loosen both air cleaner case clamp bolt and carburetor joint band, and remove the air cleaner, together with them. (Figs 4-19-1 and 2)



Fig. 4-19-1



Fig. 4-19-2

- 3) To remove the air cleaner element, remove the air cleaner case cap. (Figs. 4-19-3 and 4)



Fig. 4-19-3

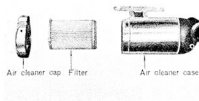

Fig. 4-19-4

2. Cleaning the Air Cleaner

Clean the filter element with compressed air. The element is made of filter paper. Keep it from water or oil.

An excessively dirty element may be cleaned in gasoline.

Chapter 5. Chassis

The YAMAHA Sports 125YAS1 (YAS1C) is designed for the outstanding durability, running stability, and maneuverability that can compare with 180-cc class racers. And yet, it is as light as a 90-cc class motor cycle and can be serviced with ease.

The diamond-shaped tubular steel frame has resulted in the use of a lesser number of members of frame-work, thus permitting even stress distribution. In short, the YAS1 (YAS1C) is ideally designed to be light-weight but highly durable.

5-1 Front Wheel

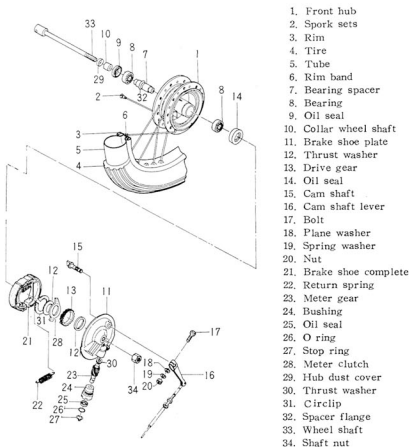

Fig. 5-1-1 Construction

1. Removal

- 1) Disconnect the brake cable and speedometer cable from the front brake shoe plate. (Fig. 5-1-2)



Fig. 5-1-2

- 2) Remove the front wheel shaft nut. (Fig. 5-1-3)



Fig. 5-1-3

- 3) Loosen the front wheel shaft lock bolt. (Fig. 5-1-4)



Fig. 5-1-4

- 4) Pull out the shaft. (Fig. 5-1-5)

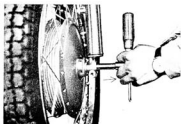

Fig. 5-1-5

- 5) Remove the front wheel assembly.
(Fig. 5-1-6)

2. Checking

- 1) Runout of the Rim

As shown in Fig. 5-1-7, measure the runout of the rim with a dial gauge.

Runout limits, 2 mm or less

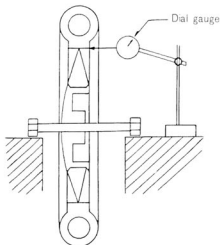

Fig. 5-1-7

- 2) Brake Shoe

Measure the outside diameter of the brake shoe with slide calipers. If it measures less than 125 mm (4.92 in.), replace it.

Smooth out a rough shoe surface, with sandpaper or with a file. (Fig. 5-1-8)

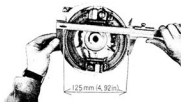

Fig. 5-1-8

- 3) Brake Drum

Oil or scratches on the inner surface of the brake drum will impair brake performance or result in abnormal noise. Clean or smooth out the surface with a rag or with sandpaper. (Fig. 5-1-9)



Fig. 5-1-9

5-2 Rear Wheel

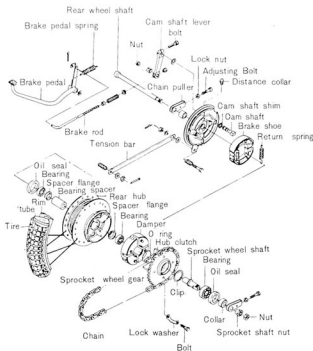

Fig. 5-2-1 Construction

1. Removal

- 1) Remove the tension bar (anchor bar) and brake rod from the rear shoe plate.
(Figs 5-2-2, 3 and 4)

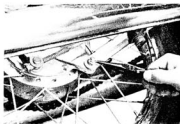

Fig. 5-2-2

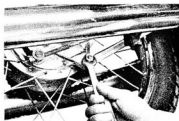

Fig. 5-2-3



Fig. 5-2-4

- 2) Remove the rear wheel shaft nut, and pull out the shaft. (Figs. 5-2-5 and 6)

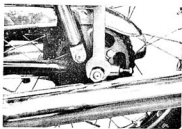

Fig. 5-2-5



Fig. 5-2-6

- 3) Remove the distance collar. (Fig. 5-2-7)
4) Remove the rear wheel assembly. (Fig. 5-2-8)



Fig. 5-2-7



Fig. 5-2-8

2. Inspection

- 1) Runout of the Rim
Check the rim for runout in the same way as the front wheel.
Maximum limit of runout.....2mm or less
- 2) Brake Shoe
Check the brake shoe in the same way as the front wheel.
Minimum limit.....125 mm (4.92 in.)
- 3) Brake Drum
Check the brake drum in the same way as the front wheel.

5-3 Rear Arm

1. Inspection

Excessive play on the rear arm shaft will result in front wheel wander, thus impairing the running stability.

As shown in Fig. 5-3-1, move the rear arm from side to side to check rear arm shaft play. If the play is excessive, replace the rear arm bushing.



Fig. 5-3-1

5-4 Fuel Tank

The fuel tank is provided with the separable side cover to minimize damage resulting from an accident.

1. Removal

a. Side Cover

1. Remove the knee grip cover and emblem.
(Fig. 5-4-1)



Fig. 5-4-1

2. Pull out the two side cover mounting bolts, and remove the side cover.
(Figs. 5-4-2 and 3)



Fig. 5-4-2



Fig. 5-4-3

b. Fuel Tank Body

1. Remove the fuel tank mounting bolt. (Fig. 5-4-4)
2. Raise the rear part of the fuel tank, and slide it rearward. Then, the fuel tank can be removed. (Fig. 5-4-5)



Fig. 5-4-4

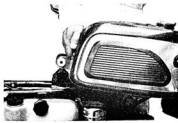

Fig. 5-4-5

5-5 Front Fork

1. Removal

- 1) Remove the front fender, and remove the upper inner tube clamping bolt.
- 2) Loosen the inner tube clamping bolt on the underbracket. (Fig. 5-5-1)



Fig. 5-5-1

- 3) Pull the outer tube downward. (Fig. 5-5-2)



Fig. 5-5-2

2. Disassembling the Outer and Inner Tubes

- 1) Place a rubber sheet or tire tube around the outer tube nut, and disassemble it in the manner as shown in Figs. 5-5-3 and 4.



Fig. 5-5-3



Fig. 5-5-4

3. Inspection

1) Inner Tube

Check the inner tube for bend and scratches. If the bend is not serious, it can be corrected with a press. (It is recommended to replace it with new one as much as possible.)

2) Oil Seal

When disassembling the front fork, be sure to replace the oil seal.

4. Assembling

a. Assembling the Front Fork

1. To assemble the front fork, reverse the disassembling sequence.

First, check if the inner tube smoothly moves up and down. (Fig. 5-5-6)

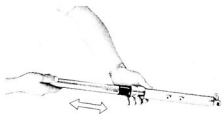

Fig. 5-5-6

b. Installing the Front Fork on the Frame

- 1) Bring up the front fork to the correct position by use of the front fork lifting rod, and tighten the underbracket mounting bolt. (Fig. 5-5-7)



Fig. 5-5-7

2) Feed front oil into the inner tube through the upper end opening. (Fig. 5-5-8)

- Oil amount: 160 cc for each side
- Oil: Mobile oil $\frac{2}{30}$8 } Mixing ratio
- Spindle oil $\frac{2}{60}$2 }
- YAMAHA gear oil (B)



Fig. 5-5-8

3) Finally, tighten the inner tube mounting bolt. (Fig. 5-5-9)



Fig. 5-5-9

5-6 Rear Cushion (Shock absorber)

The rear cushion can not be disassembled. Therefore, the following information will be limited to checking oil leakage.

1. Checking Oil Leakage

Oil seepage is sometimes seen on the bottom of the outer cover, as viewed from the outside of the rear cushion. This oil seepage may easily be mistaken for serious oil leakage, but in most cases, it is only oil seepage. Such oil seepage mostly results from melting of grease on the inner spring, and will not impair the performance of the rear cushion. To check oil leakage, take the following steps.

1) Remove the rear cushion, and depress it twice or so. If the spring quickly expands half-way, and then gradually stretches for the last 10mm (0.5 in.), the cushion is considered to be in good condition. If the spring expands quickly to the limit, there may be oil leakage. Replace the whole rear cushion assembly. (Fig. 5-6-1)



Fig. 5-6-1

Chapter 6. Electrical Equipment

6-1 General

The YAMAHA Sports 125YAS1 (YAS1C) employs an a.c. generator for its electrical system. The a.c. current produced is rectified by a single-phase, bridge silicon rectifier and supplied to the battery, ignition coils, head light, tail light, stop light, neutral pilot light, flasher light, flasher pilot and horn.

6-2 Main Component Parts

A. A. C. Generator

The A.C. generator is a sort of magneto generator, in which a six-pole magnet rotates in the stationary magnetic field inside the armature. Generator principles are similar to those of flywheel magnetos. Compared with conventional ignition and starting dynamos, the a.c. generator has the following advantages.

- 1) Simplified construction, durable and free of trouble.
- 2) Less number of parts requiring adjustments, such as regulators, and simple handling.

1. A. C. Generator Performance Curves

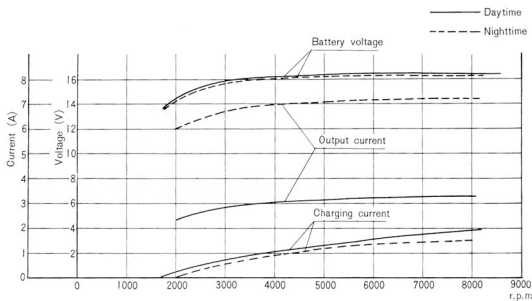

Fig. 6-2-1

2. Main Specifications of A. C. Generator

Item	Description
Maker	Hitach Ltd.
Model	K108-01
Direction of rotation and R. P. M	Left, 300-9,500r. p. m.
Voltage	12V
Normal load	Battery 12-V, 5.5AH+ 2 ignition coils
Night-time load	Normal load+ head light, 12V, 35W+ tail light, 12V, 5W+ meter light, 12V, 3W
Charging performance	
Day time	At the begining of charging: Under 1,900 r. p. m 1.3±0.5A/5,000r. p. m, at battery 16.4V 2.0±0.7A/8,000r. p. m, at battery 16.6V
Night time	1.2±0.5A/5,000r. p. m, at battery 16.2V 1.7±0.7A/8,000r. p. m, at battery 16.4V
Breaker point gap	0.3-0.35mm (0.012~0.014")
Breaker closing angle	140°±5'
Condenser capacitance	0.22±10%μF
Ignition timing	1.8±0.1 mm B. T. D. C.

3. Inspecting the A. C. Generator

When the head light is not bright or when the battery is quickly discharged, check the following points.

- 1) Measuring the Generated Voltage (No-load Voltage)
 - a. Disconnect three lead wires, yellow, green and white, from the wire harness which is connected to the generator.
 - b. Connect tester leads (a. c. 100V) to the terminals as shown in Fig. 6-2-2 (day-time) and in Fig. 6-2-3 (night-time).
 - c. Start the engine, and measure voltage at specific speeds, with the main switch both for day and night time.

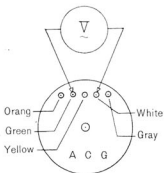

Fig. 6-2-2 Day time no-load voltage

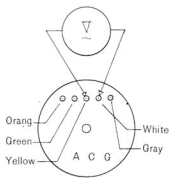

Fig. 6-2-3 Night time no-load voltage

Standard Value:

R. P. M.	Day Time	Night Time
3,000 r. p. m.	Approx. 48—58V	Same as left
5,000 r. p. m.	Approx. 83—97V	"

2) Measuring the Charging Current

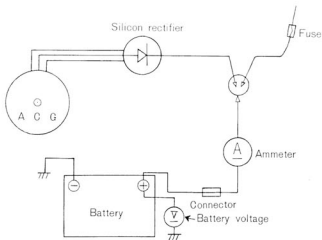

Fig. 6-2-4 Measuring the charging current

- Disconnect the battery's red lead wire connector.
- Connect the tester lead wires (D.C. ammeter, 5 A) to the connector as shown in Fig. 6-2-4.
- Start the engine, and measure the charging current at specific speeds, with the switch both for day and night time.

Note: If the battery is in a low state of charge, the charging rate will be found high.

Standard Value:

Engine R. P. M.	Day Time	Night Time
5,000 r. p. m.	$1.3 \pm 0.5A$ (Battery 16.4V)	$1.2 \pm 0.5A$ (Battery 16.2V)
8,000 r. p. m.	$2.0 \pm 0.7A$ (16.6V)	$1.7 \pm 0.7A$ (16.4V)

3) Measuring the Output Current.

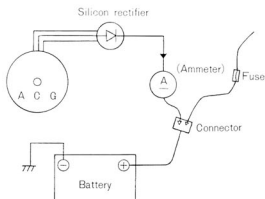

Fig. 6-2-5 Measuring the Output Current

- a. Connect a tester (D.C. ammeter, 10 A) to the battery as shown in Fig. 6-2-5, and measure the current at specific engine r.p.m., with the switch both for day and night.

Standard Value:

Engine R.P. M	Day Time	Night Time
3,000 r. p. m.	$2.8 \pm 0.5A$	$6.7 \pm 0.5A$
5,000 r. p. m.	$3.2 \pm 0.5A$	$7.1 \pm 0.5A$

B. Ignition Coil

The ignition coil is a transformer with approximately 50 times as many windings in the secondary coil as in the primary. If the electric current supplied to the primary coil (from the battery) is interrupted by a contact breaker, the primary coil will produce a 150-300 volts current surge by self-induction. This current is boosted to 7,000-10,000 volts by the mutual induction of the larger number of secondary coil windings, thus making a spark jump across the gap between the spark plug electrodes.

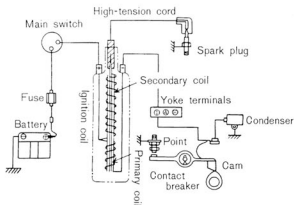

Fig. 6-2-6

Note: The type of the ignition coil is similar to that as used in "dynamo-equipped" motor cycles.

1. Specifications of the Ignition Coil

Item	Description	Remarks
Maker	Hitachi Ltd.	
Model	CII	
Spark performance	Battery 8V, 1000r.p.m. 6mm or more Battery 14V, 7,000r.p.m. 7mm or more	
Primary coil resistance	4.2Ω—5.2Ω at 20°C	
Secondary coil resistance	5KΩ—8KΩ	
Insulation resistance	10MΩ or more at 20°C	(Between primary coil terminals and case)

2. Inspection

If no sparks are produced at all or if sparks are weak, check the ignition coil and contact breaker.

1) Checking the Ignition

Coil (after removed)

Use a 12-V battery for testing the ignition coil disconnected from the engine.

If the tester reads a spark of more than 7mm, the ignition coil is in good condition.

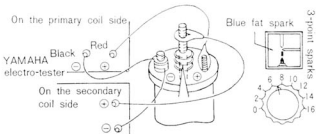

Fig. 6-2-7

2) Checking the Ignition Coil as Installed (Practical test)

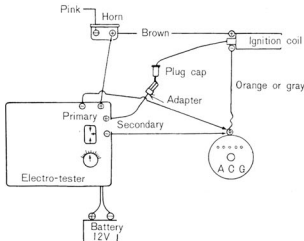

Fig. 6-2-8

- Disconnect the leads from the a.c. generator's terminal I, and connect the leads to the tester's primary and secondary (-) sides.
- Disconnect the high-tension lead from the spark plug cap, and install an adaptor (copper or steel wire) on the plug cap. Then, connect the adaptor to the tester's secondary side (+).
- Connect the tester's primary (+) side to the horn terminal (brown lead).
- Use a 12-V battery as a power source for the tester.

Note: The ignition coil can be checked by measuring the resistance value on the primary and secondary sides.

C. Silicon Rectifiers

The silicon rectifier converts the alternating current produced by the a.c. generator into a direct current, and its circuits are a single-phase, bridge type.

1. Rectifier Connection Diagram

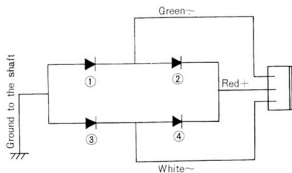

Fig. 6-2-10

- ⊙ Connect "+" to output terminals—fuse and main switch (red).
- ⊙ Connect "~" to input terminals—white and green leads to white and green leads of A. C. G., respectively.
- ⊙ The shaft is output terminal (-).

2. Simplified Measurement of Silicon Diodes (See Fig. 6-2-10.)

- a. To check diode 1, connect the green lead and shaft with tester's (ohmmeter) resistance measuring terminals (+) and (-), alternately changing connections. (For instance, connect the (+) terminal of the tester to the shaft, and the terminal to the green lead, then test the current flow. Next, change these connections, and test the current flow. If the current is found to flow through either one of these connections, diode is considered to be in good condition. If the current flows through both connections, the diode is in short-circuit. If no current flows through both connections, the diode is "burnt out."
- b. To check diode 2, connect the red lead and green lead in the same manner as mentioned in a. above, and check.
- c. To check diode 3, connect the white lead and shaft in the same manner as mentioned in a. above, and check.
- d. To check diode 4, connect the red lead and white lead in the same manner as mentioned in a. above, and check.

D. Battery

The battery is Furukawa Battery's BST3-12D or G.S.'s MG3-12E. (Both are a 12-volt, 5.5 A.H. battery). It is the same type of battery as used for the YL1, YL2, YR1 and YM2. The specific gravity is 1.280@20°C.

E. Other Parts

Name of Parts	Rating	Remarks
Head light	12V, 35/35W	HYP—AYA1
Tail/stop light	12V, 7/23W	
Speedometer	Illumination light, 12V, 3W	
	Flasher pilot light, 12V, 3W	
	Neutral light, 12V, 3W	
Horn	12V, 1.5A	
Flasher light	12V, 8W	
Spark plug	B—8HC or B—9HC	

6—3 Caution on Handling Electrical Equipment

1. Never disconnect the battery from the circuit while the engine is running.

Otherwise, the no-load voltage (400V/9,000 rpm) from the a. c. generator and a surge of voltage from the ignition coil will break the silicon diodes. Any burnt-out fuse or any loosened or disconnected connector of the battery circuit will result in silicon diode breakage as well. The silicon rectifier is ground to the shaft. Therefore, take special care when installing it on the mounting plate and installing the mounting plate on the chassis.

2. Never connect the battery in the wrong way.

Wrong connections of battery terminals will result in the short-circuit of the battery through the rectifier, thus causing a large amount of current to flow to the silicon rectifier and damaging it.

3. Always apply correct loads.

Use the loads as specified for the a.c. generator charging performance, so that the battery will be charged correctly.

The larger load will decrease the charging current, while the smaller load will increase the charging current, thus causing the battery to be easily discharged or overcharged.

4. Checking the battery fluid level

Charging by the a. c. generator is a sort of constant-current charging system. Compared with the starter dynamo or ignition dynamo employing the constant-voltage charging system, battery fluid consumption will be greater. Check the battery fluid level from time to time.

5. Handling the silicon rectifier

Never connect the circuit in the wrong way, nor expose the silicon rectifier to high temperatures. It will endure 140°C at maximum (at the junction). Temperatures higher than that will impair the rectifier.

When testing the rectifier, keep it from high voltage (crest value 400V or more) and from a large amount of current (rating 8.5A or more).

6-4 Connection Diagram

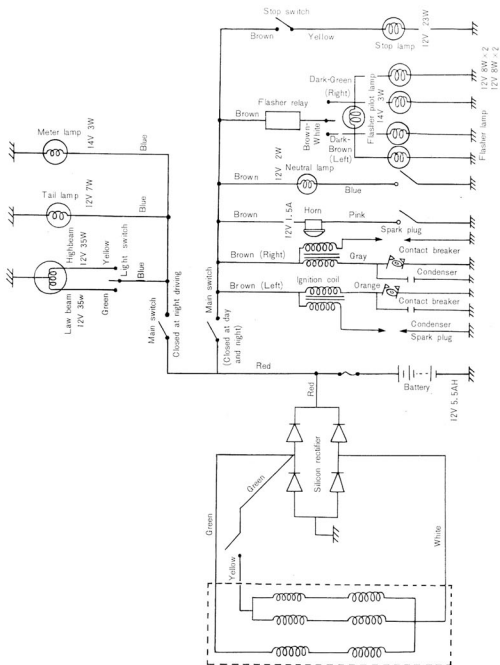

M E M O

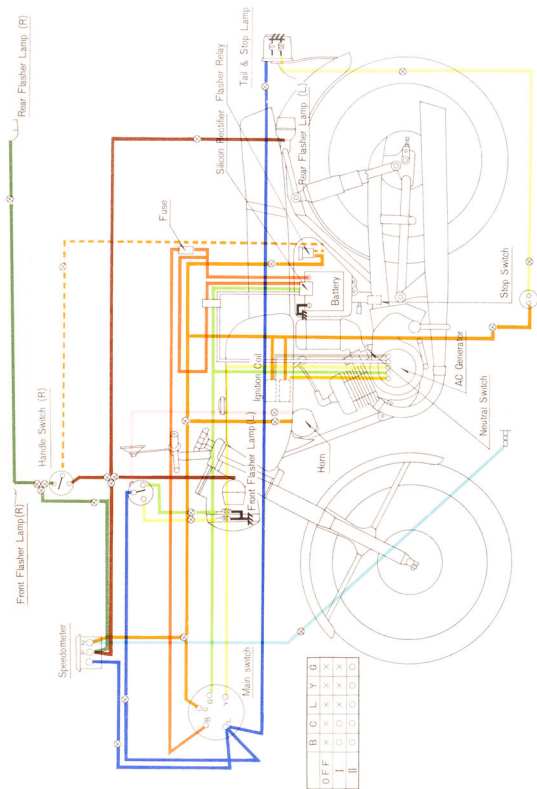

	B	C	L	Y	G
OFF	x	x	x	x	x
I	o	o	o	x	x
II	o	o	o	o	o



YAMAHA MOTOR CO., LTD.

PRINTED IN JAPAN

45.10×3.0-2 

www.legacy.yamaha-entuse.com