



**YAMAHA**

**DT250D**

**DT400D**

**OWNER'S MANUAL**

1M1-28199-10

# INTRODUCTION

Thank you for buying the Yamaha.

This model is the product of many years of Yamaha experience and strict Yamaha quality control. The resultant ease of handling, high performance and reliability promise you full pride of ownership.

This manual is written in such a way as to provide the owner with a good understanding of the features, operation, maintenance and inspection of this vehicle. Information required for safe and reliable use of the vehicle is contained in this manual, so read it carefully and completely before operating the vehicle. If you have any questions concerning the information, ask your dealer before operating the vehicle.

**NOTICE:** \_\_\_\_\_

Some data in this manual may become outdated due to improvements made to the machine in the future. If there is any question concerning this manual, consult your nearby Yamaha dealer.

---

**SERVICE DEPT.  
INTERNATIONAL DIVISION  
YAMAHA MOTOR CO., LTD.**



# CONTENTS

	PAGE
FEATURES .....	1
NOMENCLATURE .....	2
MACHINE IDENTIFICATION .....	3
CONTROL FUNCTIONS .....	4
PRE-OPERATION CHECKS .....	11
OPERATION AND IMPORTANT RIDING POINTS .....	13
PERIODIC MAINTENANCE AND MINOR REPAIR .....	19
CLEANING AND STORAGE .....	50
MISCELLANEOUS .....	53
WARRANTY INFORMATION .....	55
SPECIFICATIONS .....	56

# FEATURES

## **Monocros suspension (DE CARBON type)**

The rear spring preload can be adjusted to suit rider preference and riding conditions. The nitrogen/oil type rear shock absorber has improved the stability of the machine.

## **Trials universal tires**

This motorcycle is equipped with trials universal tires as standard equipment. This tire pattern is stable for running at moderate speeds on paved roads and off the road it provides excellent traction.

## **Torque induction system**

The reed valve has been adopted as the induction system for the DT250D (DT400D). This system, utilizing its unique 7-port construction, ensures excellent engine performance from low to high speed.

## **Autolube system**

Yamaha Autolube provides superior engine lubrication which extends service life.

## **Starter jet equipped carburetor**

Equipped with this unique starter jet, the YAMAHA DT250D (DT400D) is quick starting under all conditions.

## **Engine stop switch**

The engine can be stopped during any emergency by a quick flip of the switch.

## **Easier starting**

With the primary coupled starting system, the engine can be started in any gear simply by disengaging the clutch. And the DT400D kick mechanism is linked to an automatic decompression relief valve within the cylinder to reduce compression pressure for easier starting.

## **Capacitor discharge ignition (DT400D)**

This system provides higher ignition voltage for better ignition performance. Additionally, there are no breaker points to wear thereby reducing efficiency.



# NOMENCLATURE



RIGHT SIDE



LEFT SIDE

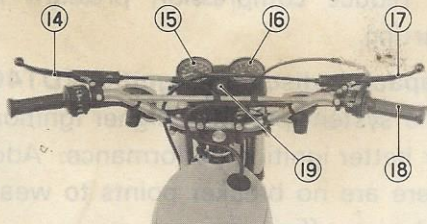

INSTRUMENTS

- |                 |                   |
|-----------------|-------------------|
| 1. Taillight    | 11. Rear wheel    |
| 2. Muffler      | 12. Side stand    |
| 3. Kick crank   | 13. Change pedal  |
| 4. Headlight    | 14. Clutch lever  |
| 5. Front fender | 15. Speedometer   |
| 6. Front wheel  | 16. Tachometer    |
| 7. Brake pedal  | 17. Brake lever   |
| 8. Footrest     | 18. Throttle grip |
| 9. Front fork   | 19. Main switch   |
| 10. Fuel tank   |                   |

# MACHINE IDENTIFICATION

## Frame serial number

The frame serial number is stamped on the right side of the steering head stock.

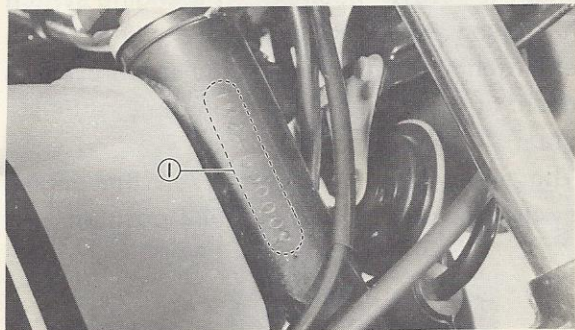

1. Frame serial number

## Engine serial number

The engine serial number is stamped into the raised part of the right rear section of the engine.

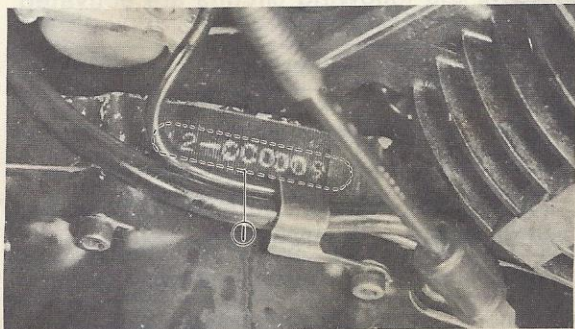

1. Engine serial number

## NOTE:

The first three digits of these numbers are for model identifications; the remaining digits are the unit production number. The engine and frame serial numbers are usually identical but they may sometimes be 2 or 3 numbers apart.



# CONTROL FUNCTIONS

## Main switch

With the ignition key switched to the "ON" position, the following circuits are activated.

Circuit	Instruction for operation
Ignition	Kick start engine
Headlight	Turn on light switch
Taillight	Turn on light switch
Stoplight	Apply brake
Meter light	Turn on light switch
Horn	Depress horn button
Flasher light	Turn on flasher switch



## Handlebar switches

The handlebar switches are located near the right and left handle grips (see illustration) and are used for the following functions:

### "ENGINE STOP" switch

Make sure that the engine stop switch is positioned to "RUN" position. The engine switch has been equipped to ensure safety in an emergency such as when the motorcycle is upset or trouble takes place in the throttle system.

The engine will not start when the engine switch is turned to the "OFF" position.

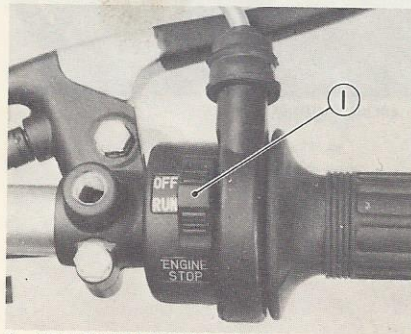

1. "ENGINE STOP" switch

## "LIGHT" switch

Turn the light switch to the "ON" position to turn on the headlight and the taillight.

## "LIGHTS" (dimmer) switch

Turn to the "HI" position for the high beam and to the "LO" position for the low beam.

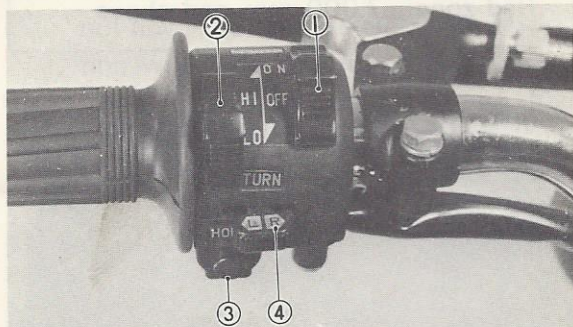

1. "LIGHTS" switch
2. Dimmer switch "LIGHTS"
3. "HORN" switch
4. "TURN" switch

## "HORN" switch

Press button to sound the horn.

## "TURN" switch

This is a three-way switch: the center position is off; turn to the "L" position for the left

flasher and to the "R" position for the right flasher.

## Indicator lights

Turn indicator light (orange):

This light flashes when the turn indicator switch is "ON".

Neutral light (green):

This light comes on when the transmission is in neutral.

High beam indicator "BEAM" (blue):

This light comes on when the headlight high beam is used.



1. "OIL" indicator light
2. "NEUTRAL" indicator light
3. "HIGH BEAM" indicator light
4. "TURN" indicator light



## "OIL" indicator light (red):

This light comes on when the oil in the autolube tank is low, thus warning the rider. The rider can check the warning light circuit by putting the machine in neutral. Both the neutral and oil indicator light should come on.

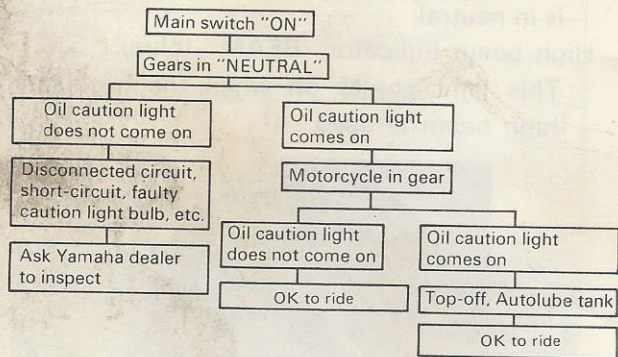

## Speedometer

The odometer and trip odometer are built into the speedometer. The trip odometer can be reset to "0" by turning the reset knob.

## Tachometer

The tachometer is provided so the rider can keep engine revolutions (rpm) within the ideal power range.

Do not operate in the red zone.  
Red zone: 7,000 rpm and above

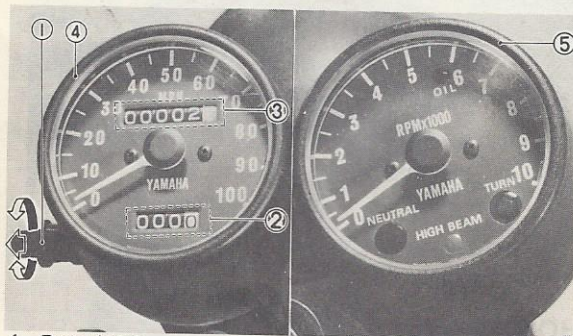

1. Reset knob
2. Trip odometer
3. Odometer
4. Speedometer
5. Tachometer

## Fuel petcock

The fuel petcock functions to supply fuel from the tank to the carburetor and also to filter the fuel.

The fuel petcocks have the following three positions:

**OFF:** With the lever in this position fuel will not flow. Return the lever to this position when the engine is not running.

**ON:** With the lever in this position fuel flows to the carburetor. Normal riding is done with the lever in this position.

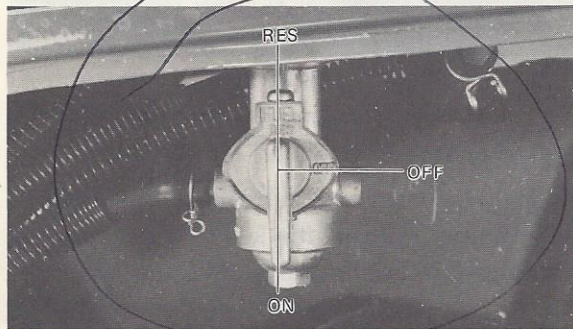

**RES:** This indicates "RESERVE". If you run out of fuel while riding, move the lever to this position. Then, fill the tank at the first opportunity.

## Starter jet lever (choke lever)

When cold, the engine requires a richer fuel mixture for starting. A separate starter circuit, which is controlled by the starter jet lever, supplies this mixture.

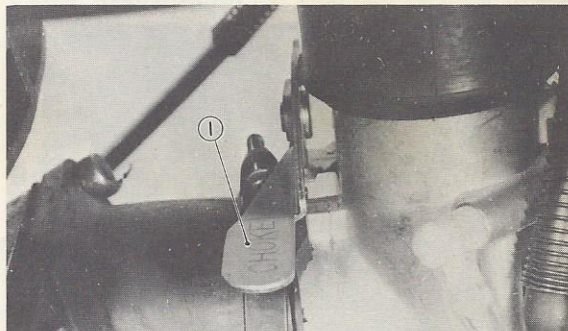

1. Starter jet lever



Push the lever down to open the circuit (for starting) and pull it up to close the circuit.

### Kick starter

To start the engine, rotate the kick crank, push down lightly with foot until gears engage, and then kick with full strength. This model has the primary kick starter so the engine can be started in gear if the clutch is disengaged. As normal practice, however, shift to neutral before starting.

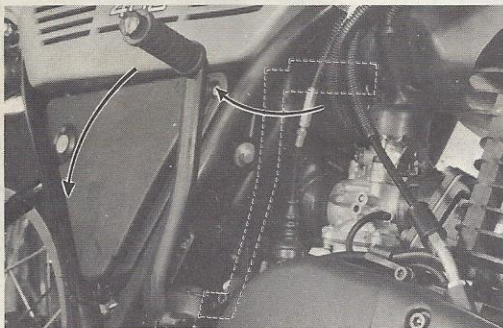

### Side cover lock

To use the owner's tool kit or remove the air

filter element, rotate the key hole cover on the side cover door and insert the key into key hole. Release the lock, by turning about 1/4 turn clockwise. To lock reverse the above steps.

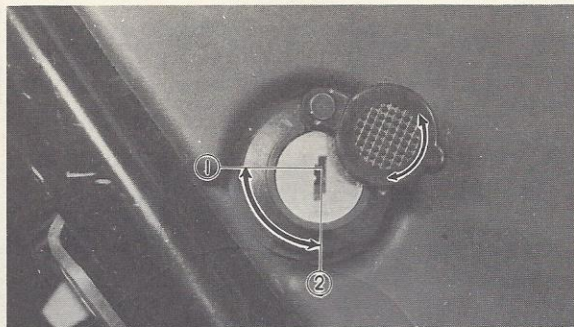

1. Open 2. Lock

### Steering lock

To lock the steering, turn the handlebars to fully the right, insert the key into the steering lock and turn the key about 1/8 turn counter-clockwise. Then push the key in and turn it about 1/8 turn clockwise. After checking if

the lock is engaged, remove the key from the lock. To release the lock, reverse the above steps.

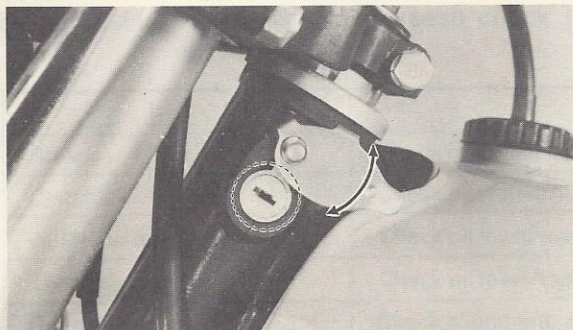

### Helmet holder

To open the helmet holder, insert the key in the lock and turn it clockwise.

To lock the helmet holder, replace the holder in its original position.

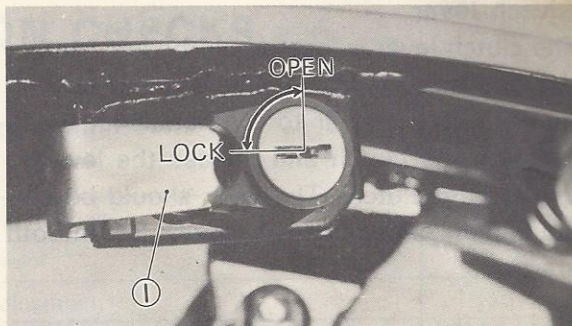

1. Helmet holder

### Front brake lever

The front brake lever is located on the right handlebar; pull it toward the handlebar to activate the front brake.

### Rear brake pedal

The rear brake pedal is on the right side of the motorcycle. Press down on the brake pedal to activate the rear brake.



## Clutch lever

The clutch lever is located on the left handlebar and disengages or engages the clutch. Pull the clutch lever to the handlebar to disengage the clutch and release the lever to engage the clutch. The lever should be pulled rapidly and released slowly for smooth starts.

## Gear shifting

The gear ratios of the constant mesh 5 speed transmission are ideally spaced. The gears can be shifted by using the change pedal on the left side of the engine.

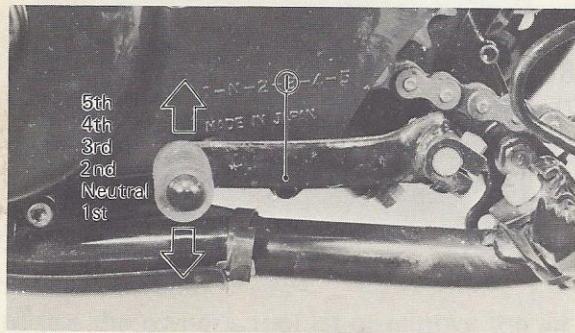

1. Change pedal

# PREOPERATION CHECKS

Before using this motorcycle please check the following points:

Item	Routine	Page
Brakes	Check operation/adjustment	23, 24
Clutch	Check operation/lever adjustment	25
Autolube tank (Engine oil)	Check oil level/top-up as required	12
Transmission	Check oil level/top-up as required	32, 33
Drive chain	Check alignment/adjustment/lubrication	35, 36
Throttle	Check for proper throttle and autolube cable operation	28
Wheels and tires	Check pressure/runout/spoke tightness/axle nuts	12, 13
Lights/signals	Check headlight/tail — stoplights/flasher light/horn	5, 25

**NOTE:** \_\_\_\_\_

Pre-operation checks should be made each time the machine is used. Such an inspection can be thoroughly accomplished in a very short time. The added safety it assures is more than worth the time involved.

---



## Fuel

Make sure there is sufficient fuel in the tank.

Add fuel as necessary.

Recommended gasoline:

Regular or low read gasoline

Fuel tank capacity:

9.0 lit (2.4 U.S.gal.)

## Engine oil

Make sure there is sufficient engine oil in the autolube tank. Place the machine on a level place and hold it in an upright position.

Remove the side cover and using the dip stick, check the oil level. Add oil as necessary.

Recommended oil:

See page 31 "Engine oil section"

Oil tank capacity:

1.1 lit (1.2 U.S.qt.)



1. Oil tank filler cap 2. Dip stick

## Tires

Check the tire pressure and check the tires for wear.

### Tire pressure

	Front	Rear
Off-road	0.9 kg/cm <sup>2</sup> (13 psi)	1.1 kg/cm <sup>2</sup> (16 psi)
On paved road	1.6 kg/cm <sup>2</sup> (22 psi)	1.8 kg/cm <sup>2</sup> (26 psi)

If a tire tread shows cross wise lines, it means that the tire is worn to its limit. Replace the tire.

## OPERATION AND IMPORTANT RIDING POINTS

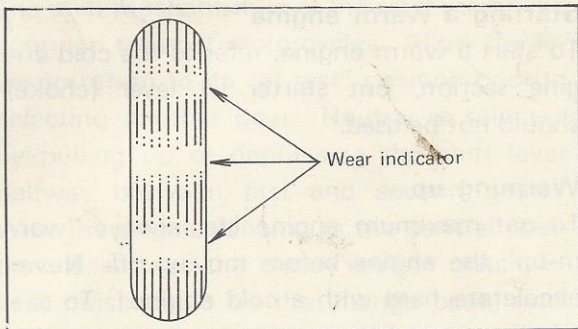

### WARNING:

It is dangerous to ride with a worn-out tire. When a tire tread begins to show lines, have your Yamaha dealer replace the tire immediately.

### CAUTION

Before riding this motorcycle, become thoroughly familiar with all operating controls and their function.

Consult your Yamaha dealer regarding any control or function you do not thoroughly understand.

### Starting a cold engine

1. Shift transmission into neutral.
2. Turn the fuel petcock to "ON".
3. Turn the ignition key to "ON" position.

### NOTE:

At this time, both neutral and oil indicator lights should be on. If lights do not come on ask Yamaha dealer to inspect.



4. Turn the engine stop switch to the "RUN" position.
5. Open (push down) the carburetor starter jet lever and completely close the throttle grip.
6. Kick the kick crank with full strength to start the engine.
7. After the engine starts, warm up for one or two minutes.

Make sure the starter jet lever is returned to the original position before driving.

### Starting a warm engine

To start a warm engine, refer to the cold engine section; but starter jet lever (choke) should not be used.

### Warming up

To get maximum engine life, always "warm-up" the engine before moving off. Never accelerate hard with a cold engine! To see whether or not the engine is warm, see if it responds to throttle normally with the starter jet (choke) turned off.

### CAUTION:

See "Break-in Section" prior to operating engine for the first time.

### Shifting

A 5-speed transmission is employed. Low gear is at the bottom of the shift pattern; high gear at the top of the shift pattern; neutral is located half-way between first and second gear positions.

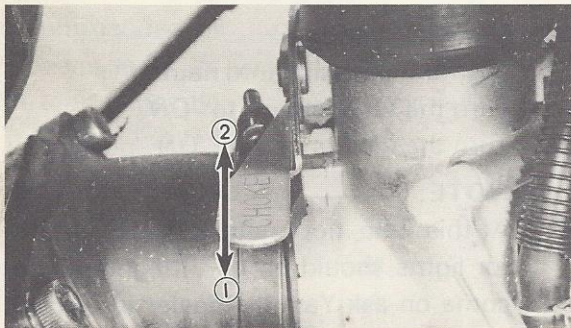

1. OPEN
2. CLOSED

The shift mechanism is of the ratcheting type common to most motorcycles. Allow the lever to return to its "at rest" position prior to selecting another gear. Neutral is selected by pulling up or depressing the shift lever halfway between first and second gears. With the engine running in the neutral position, disengage the clutch (pull in clutch lever), press down on the change pedal until low gear is engaged, remove foot from shift lever, increase engine speed slightly, slowly release clutch lever while advancing throttle. Repeat procedure for remaining gears.

**NOTE:** \_\_\_\_\_

Use the transmission to keep engine speed in its ideal rpm range (3,000 ~ 6,000 r.p.m.).

---

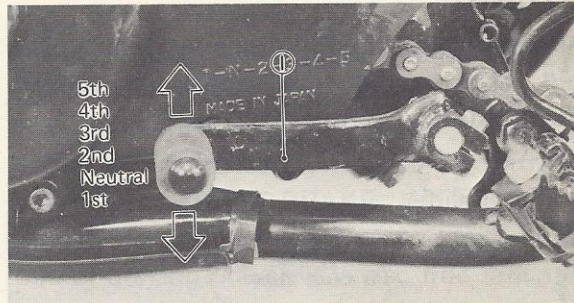

1. Change pedal

### Going uphill

When starting to climb a gentle grade, open the throttle little by little to avoid losing engine speed and power. When climbing a steep grade, shift down from THIRD to SECOND or from SECOND to FIRST as required.

### Going downhill

On a long downgrade or sharp descent, don't rely on the brakes alone, but use the engine compression as a brake; shift into THIRD or SECOND as required by the grade and close the throttle.



**CAUTION:** \_\_\_\_\_

Never turn off the ignition switch on a long hill. This may cause the spark plug to foul, in addition to being unsafe.

---

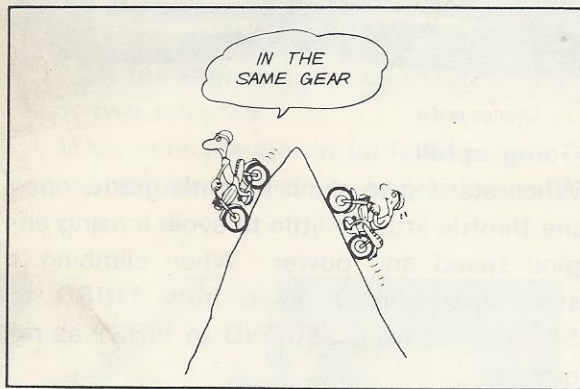

**NOTE:** \_\_\_\_\_

When using engine braking for long periods, it is very important not to exceed maximum recommended rpm (tachometer red zone). It is also necessary to open the throttle occa-

sionally because the engine relies on the fuel for internal cooling.

---

### Off-road riding

When riding your motorcycle off-road, safety parts may break or fall off due to shock from the ground or due to accidents such as falling, and breakage or loss of parts may result. It is advisable to remove all safety parts before you start riding.

Parts to be removed: Headlight Tail/Stoptlight, Flasher light and meters, etc.

Caution on riding over paved roads at high speeds:

This model is equipped with tires having a block pattern. As a result, the area where the tire contacts the ground is smaller compared with other types of street tires. Therefore, take care to avoid slipping your motorcycle when you are cornering at high speeds and, at sharp angles.

## Stopping

There are several ways to stop. Pulling in the clutch lever and twisting the throttle grip in the close direction will permit you to gradually glide to a stop.

Downshifting through the gears, using the drag of the engine to slow down is another. However, the best method, and the one most universally used, is to use both engine compression (downshifting through the gears as the machine slows) and the front and rear brakes.

When stopping, gradually apply the rear brake while twisting the throttle grip in the closed direction. After the rear brake starts to take hold, gradually apply the front brake. As the machine continues to slow, shift down through the gears using engine compression to aid the slowing effect. When shifting down, watch the tachometer to see that the engine does not over-revolution.

## NOTE: \_\_\_\_\_

During periods of inclement weather such as snow, rain, sleet, or ice or on poor road surfaces where traction is minimal, or in a sharp corner, IT IS NOT ADVISABLE TO FIRMLY APPLY THE FRONT BRAKE. While it is true that the front brake supplies the greater portion of braking power, it is also true that stability can be lost very easily if it is used incautiously under the above conditions.

## Parking

When parking, stop the engine and remove the ignition key. Make it a habit to turn the fuel petcock to "OFF" whenever stopping the engine.

## NOTE: \_\_\_\_\_

Select a parking place where the motorcycle is not apt to fall.

## Engine break-in

There is never a more important period, in the



life of your motorcycle, than the period between zero and 800 km. (500 mi.). For this reason we ask that you carefully read the following material. Because the engine is brand new, you must not put an excessive load on it for the first several hours of running. During the first 400 km. (250 mi.) the various parts in the engine wear and polish themselves to the correct operating clearances. During this period prolonged full throttle operation, or any condition which might result in excessive heat of cylinder, must be avoided.

If any abnormality is noticed during this period, ask your Yamaha dealer to check.

1. 0 ~ 160 km. (0 ~ 100 mi.):

Avoid operation above 4,000 rpm. Allow a cooling off period of 5 to 10 minutes after every hour of operation. Vary the speed of the motorcycle from time to time. Do not operate it at one, set throttle position.

2. 160 ~ 400 km. (100 ~ 250 mi.):

Avoid prolonged operation above 5,000 rpm. Allow the motorcycle to rev freely through the gears but do not use full throttle at any time.

3. 400 ~ 800 km. (250 ~ 500 mi.):

Avoid prolonged full throttle operation. Avoid cruising speeds in excess of 6,000 rpm.

4. 800 km. and beyond (500 mi. and beyond):

Avoid prolonged fully throttle operation. Avoid engine speeds in excess of 7,000 rpm. Vary speeds occasionally.

**CAUTION:** \_\_\_\_\_

**If any engine trouble should occur during the break-in period, consult your Yamaha dealer immediately.**

\_\_\_\_\_

# PERIODIC MAINTENANCE AND MINOR REPAIR

## TOOL KIT

The tools provided in the owner's tool kit are sufficient for periodic maintenance and minor repair purpose, except that a torque wrench (not provided) is also necessary to properly tighten nuts and bolts.

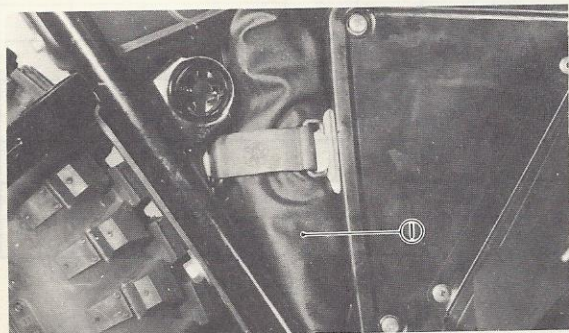

1. Tool kit

Should you desire additional service information on this model a copy of the Service Manual can be purchased from any Authorized Yamaha Dealer.

## PERIODIC MAINTENANCE

Periodic inspection, adjustment and lubrication will keep your motorcycle in the safest and most efficient condition. Safety is an obligation of the motorcycle owner.

## PERIODIC MAINTENANCE CHART

The most important points of motorcycle inspection, adjustment and lubrication are explained below; if the owner is not familiar with motorcycle service, this work should be done by a Yamaha dealer.



## PERIODIC MAINTENANCE INTERVALS

Page	Item	Remarks	Initial km (mile)				Thereafter every km (mile)		
			400 (250)	800 (500)	1,600 (1,000)	3,200 (2,000)	1,600 (1,000)	3,200 (2,000)	6,400 (4,000)
29~31	Spark plug	Inspect/clean or replace	○			○		○	
26~28	Carburetor	Check operation/adjust		○		○		○	
33, 34	Air filter	Oiled foam rubber type — clean and reoil (See "NOTE #1")	Once per month or every 1,600 km (1,000 mile)						
34, 35	Fuel petcock	Remove and clean	○		○		○		
46, 47	Battery	Top-off/check specific gravity and breather pipe	○	○	○	○	○		
—	Ignition timing	Adjust/clean or replace parts		○				○	
23, 24	Brake system (comp.)	Check/adjust — repair as required		○	○			○	
25, 26	Clutch	Check/adjust as required		○	○			○	
35, 36	Drive chain	Adjust tension/clean and lubricate (See "NOTE #2")	Every 400 km (250 mile)						
—	Front fork and rear shock absorber	Check operation, damaged and oil leakage		○		○			○
12, 13	Wheels and tires	Pressure/spoke-tension/runout	○	○	○		○		
—	Fittings/fasteners	Tighten before each trip and or ...	○		○			○	
—	Cylinder	Check compression				○			○

**NOTE:**

---

- #1. Oiled foam rubber type air filters must be wet with oil at all times.  
If the machine is ridden off-road in wet or dusty conditions, the element should be serviced every 160 km (100 miles).
  - #2. Drive chain should be cleaned and lubricated every 80 ~ 160 km (50 ~ 100 miles) when operated in dusty or wet conditions.
-



# LUBRICATION INTERVALS

Page	Item	Remarks	Type	Initial km (mile)				Thereafter every km (mile)		
				400 (250)	800 (500)	1,600 (1,000)	3,200 (2,000)	1,600 (1,000)	3,200 (2,000)	6,400 (4,000)
32,33	Transmission oil	Replace	Yamalube 4-cycle oil or SAE 10W/30 "SE" motor oil	○		○			○	
36,37	Drive chain	Remove/clean/lube/ adjust	Yamaha chain and cable lube SAE 10W/30 motor oil			○			○	
45	Control/meter cables	Apply thoroughly	Yamaha chain and cable lube SAE 10W/30 motor oil			○	○		○	
45	Throttle grip/ housing	Apply lightly	Lithium base grease		○		○			○
—	Speedometer gear housing	Apply lightly	Lithium base grease				○			○
39,40	Front fork oil	Drain completely — refill	Yamaha fork oil	○			○			○
—	Rear arm pivot shaft	Apply grease fully	Medium-weight wheel bearing grease				○			○
—	Brake pedal shaft	Apply lightly	Soft chassis lube grease				○			○
—	Wheel bearings	Do not over-pack	Medium-weight wheel bearing grease				○			○
—	Point cam lubri- cation wicks	Apply very lightly	Light-weight machine oil			○			○	
—	Steering ball races	Inspect thoroughly/pack moderately	Medium-weight wheel bearing grease			○				○

## Front brake adjustment

Front brake should be adjusted to suit rider preference with a minimum cable slack of 5 ~ 8 mm (0.2 ~ 0.3 in) play at the brake lever pivot point. Adjustment is accomplished at one of two places; either the handle lever holder or the front brake hub.

1. Loosen the adjuster locknut.
2. Turn the cable length adjuster in or out until adjustment is suitable.
3. Tighten the adjuster locknut.

When it is impossible to make an adjustment at the brake lever, ask a Yamaha dealer for adjustment at the brake shoe plate.

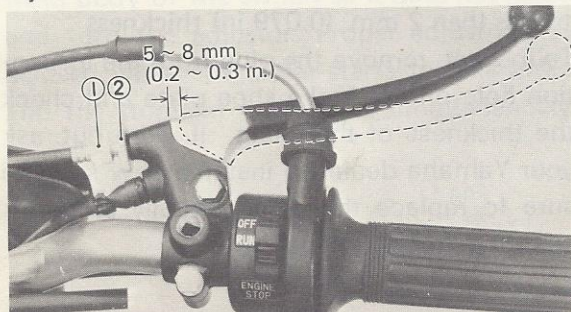

1. Adjuster 2. Locknut

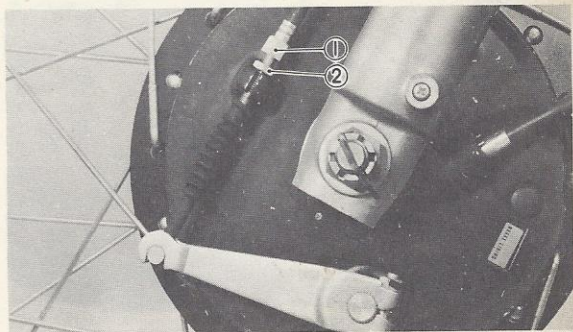

1. Adjuster 2. Locknut

## Brake pedal position adjustment

The position of the rear brake pedal should be adjusted so as to suit the rider. Loosen the locknut and adjust the pedal height by turning the adjuster bolt. After adjusting, check for correct rear brake play and stop light operation. Do not forget to tighten the locknut.



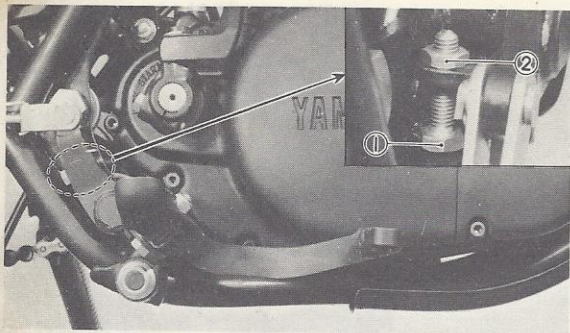

1. Adjustor bolt    2. Locknut

### Rear brake adjustment

Adjust rear brake pedal play to suit rider, providing a minimum of 20 mm (0.8 in) freeplay. Adjust as follows:

Turn the adjuster on the rear brake ferrule in or out until brake pedal freeplay is suitable (20~30 mm (0.8~1.1 in) freeplay).

Check whether or not the stoplight operates correctly after rear brake adjustment.

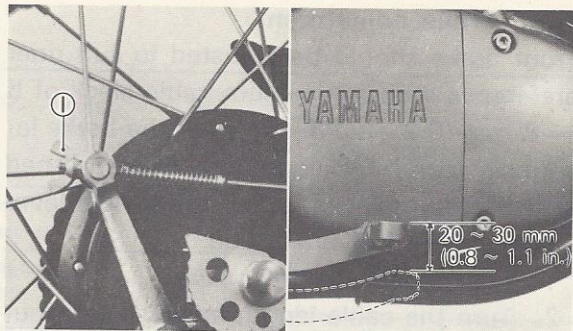

1. Adjustor

### Brake lining inspection

The specified thickness of the brake lining is 4 mm. (0.16 in). The lining should be replaced when the brake lining material wears to less than 2 mm. (0.079 in) thickness.

To inspect, remove the plug from the inspection hole on the brake shoe plate and check the thickness of the lining. If worn out, ask your Yamaha dealer to install a new set. Be sure to replace the plug carefully so water cannot enter the shoe plate.

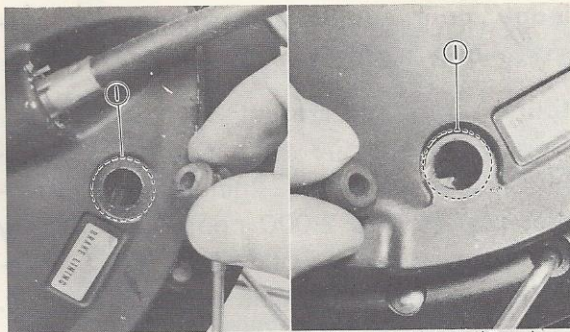

1. Inspection hole (Front)

1. Inspection hole (Rear)

### Stoplight switch adjustment

The stoplight switch is operated by movement of the brake pedal. To adjust, hold the main body of the switch so it does not rotate and turn the adjuster. Proper adjustment is achieved when the brake starts to take effect and the stoplight illuminates simultaneously.

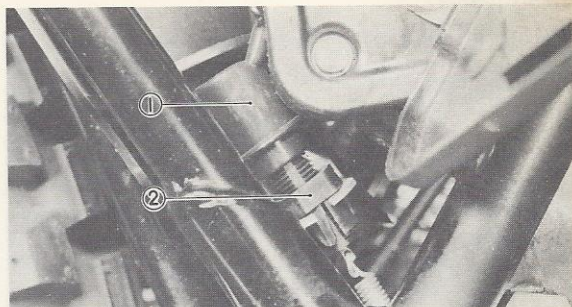

1. Main body 2. Adjustor

### Clutch adjustment

The clutch cable play can be adjusted in two ways: (1) using the adjuster attached to the clutch cable or (2) using the adjuster attached to the clutch lever holder. Loosen the locknut and turn the adjuster until the clearance between the front of the clutch lever and the lever holder is 2 ~ 3 mm. (1/16 ~ 1/8 in.).

#### NOTE:

When it is impossible to make an adjustment at the clutch lever, ask a Yamaha dealer for adjustment at the push rod 2.



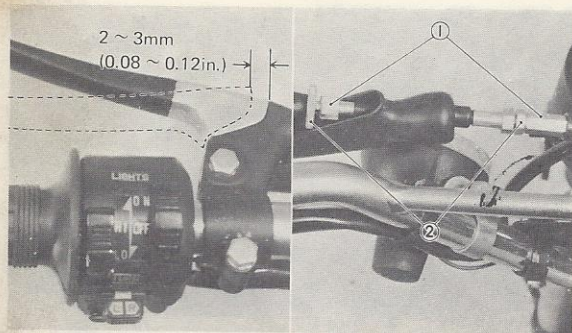

1. Adjustor 2. Locknut

### Carburetor adjustment

The carburetor is a vital part of the engine and requires very sophisticated adjustment. Most adjusting should be left to a Yamaha dealer who has the professional knowledge and experience to do so. However, the following point may be serviced by the owner as part of his usual maintenance routine.

#### CAUTION:

The carburetor was set at the Yamaha factory after many tests. If the settings are disturbed without having technical know-

ledge, poor engine performance and damage may result.

### Idling r.p.m. adjustment

Start the engine and warm it up for a few minutes (normally, 1 or 2 minutes) at approximately 1,000 to 2,000 r.p.m., occasionally raising to 4,000 to 5,000 r.p.m. for a few seconds. When the engine responds quickly, the warm up is complete.

Tighten or loosen the throttle stop screw as required to obtain the specified engine r.p.m. while watching the tachometer.

Standard idling r.p.m.:

DT250D ..... 1,200 ~ 1,300 r.p.m.

DT400D ..... 1,400 ~ 1,500 r.p.m.

#### NOTE:

If the specified idling speed can not be obtained after performing the above adjustment, consult your Yamaha dealer.

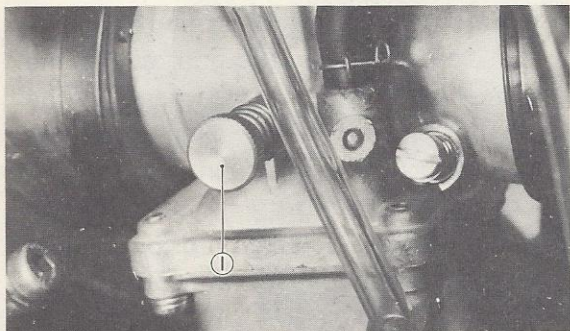

1. Throttle stop screw

### Carburetor inspection

In addition to the above adjustment, check the following periodically:

1. Are the carburetor holding bolts loose ?
2. Is the cleaner joint secure ?
3. Is the overflow pipe or air vent pipe out of place or in clogged ?
4. Is the mixing chamber top on tightly ?

### Inspection and adjustment of play in throttle cable 2

1. Remove the bolt (a) and fully turn the throttle grip out.

2. The mark on the throttle slide should be aligned with the bolt hole as illustrated. If adjustment is necessary:
  - a. Loosen the locknut.
  - b. By turning the adjuster in or out, adjust the throttle slide.
  - c. Tighten the locknut.
4. Close the throttle grip and fully open it again. Check the position of slide. Install the bolt.

### NOTE:

During this operation, take care so that not dust enters the carburetor.

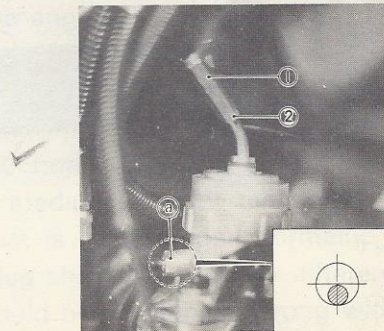

1. Adjustor
2. Locknut
- a. Bolt



## Inspection and adjustment of play in throttle cable 1

After engine idling r.p.m. and throttle cable 2 are set, check play in turning direction of throttle grip. The play should be 5–10 mm (0.2–0.4 in) at grip flange. Loosen the locknut and turn the wire adjuster to make the necessary adjustment. After adjusting, be sure to tighten the locknut properly.

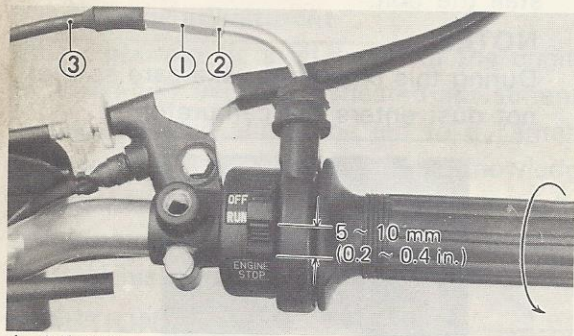

1. Adjuster
2. Locknut
3. Throttle cable 1

## Autolube pump cable adjustment

1. Fully open the throttle grip, adjust the pump cable so that the mark on the pump adjusting pulley aligns with the adjusting pulley guide pin.
  - a. Loosen the locknut.
  - b. By turning the adjuster in or out, adjust so that the pump marks are correctly aligned.
  - c. Tighten the locknut.
2. Back off the throttle grip once, and fully open it again. Make sure that the pump cable is correctly adjusted.

**NOTE:** \_\_\_\_\_

Before adjusting Autolube pump cable always set throttle cable free play first.

\_\_\_\_\_

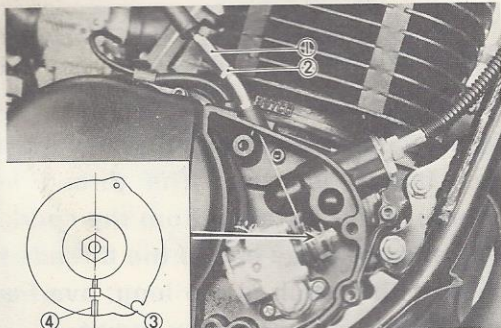

1. Adjuster
2. Lock nut
3. Adjusting pulley guide pin
4. Mark

### Bleeding the Autolube pump

If the pump runs out of oil, it must be bled to release air trapped in it. Remove the Phillips head bleed screw, twist the throttle to full open position (this turns the Autolube pump to maximum stroke), and rotate the plastic manual starter pump plate until only oil comes out the bleed hole (air stops coming out with the oil). Reinstall and tighten the bleed screw.

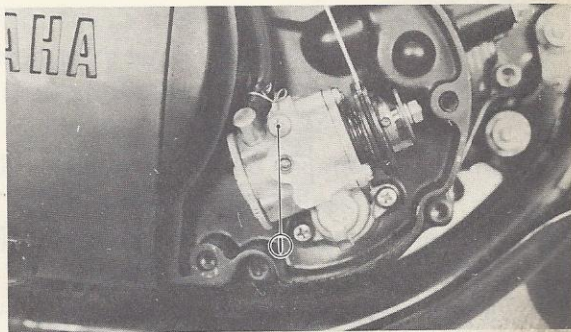

1. Bleed screw

### Spark plug inspection

The spark plug is an important engine component and is easy to inspect. The condition of the spark plug can indicate something of the engine.

Normally, all spark plugs from the same engine should have the same coloration—on the white porcelain insulator around the center electrode. The ideal coloration at this point is a medium to light tan color for a machine that is being ridden normally. If one spark plug shows a distinctly different color, there could be something wrong with the engine.



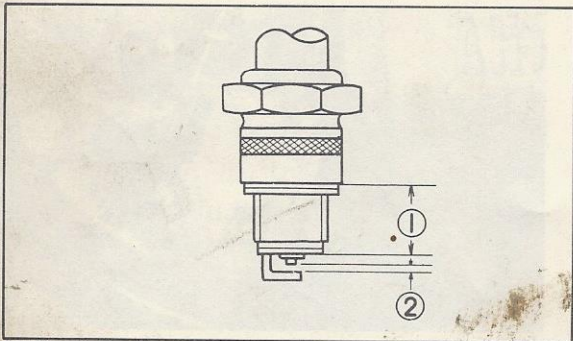

1. Reach 2. Gap

For example, a very white center electrode porcelain color could indicate an intake tract air leak or carburetion problem for that cylinder. Do not attempt to diagnose such problems yourself. Instead, take the machine to your Yamaha dealer.

You should periodically remove and inspect the spark plug because heat and deposits will cause any spark plug to slowly break down and erode. If electrode erosion becomes excessive, or if carbon and other deposits are excessive, you should replace the spark plug with one of the proper type.

Standard spark plug: B-8ES (NGK)

**CAUTION:**

Spark plugs are produced in several different thread lengths. The thread length (reach) is the distance from the spark plug gasket seat to the end of the threaded portion. If the reach is too long, overheating and engine damage may result.

If the reach is too short, spark plug fouling and poor performance may result; also, carbon will form on the exposed threads resulting in combustion chamber hot spots and thread damage. Always use a spark plug with the proper reach.

Spark plug reach: 19 mm (3/4 in)

Before installing any spark plug, measure the electrode gap with a wire thickness gauge and adjust to specifications.

Spark plug gap:

0.6 ~ 0.7 mm

(0.024 ~ 0.028 in)

When installing the plug, always clean the gasket surface and use a new gasket. Wipe off any grime from the threads and torque the spark plug properly.

Spark plug torque:

1.5 ~ 2.5 m·kg

(11 ~ 18 ft·lb)

### Engine oil

Use the engine oils in the following list. We recommend Yamalube 2-cycle oil (available at most Yamaha dealers) but, if other oils are

used, select from the following list which is given in order of preference.

1. 2-stroke engine oil labelled "BIA certified for service TC-W".
2. Another 2-stroke engine oil recommended for air cooled engines.
3. SAE 30 weight, detergent type automobile engine oil with an "SE" rating. This last oil should be used only as an emergency measure when 2-stroke oils are not available.

### NOTE:

Oil viscosity increases in very cold weather (where the normal temperature is below 0°C 32°F) and oil does not circulate as well. In such areas, consult your Yamaha dealer.

Oil tank capacity:

1.1 lit. (1.2 U.S.qt.)



## Transmission oil

The only servicing for you to do is to check and fill the transmission lubricating oil. The transmission dip stick is located right above the kickstarter. To check the level, warm the engine up for several minutes, screw the dip stick completely out and then just rest the stick in the hole.

### NOTE:

When checking transmission oil level with the dip stick, let the unscrewed dip stick just rest on the case threads. Also, be sure the machine is positioned straight up and on both wheels.

Recommended oil:

Yamalube 4-stroke or SAE 10W/30 motor oil, type "SE"  
1,100 c.c. (1.2 U.S.qt.)

The dip stick has a Minimum and a Maximum mark, and the oil level should be between the

two. If the level is lower, then add sufficient oil to raise it to the proper level.

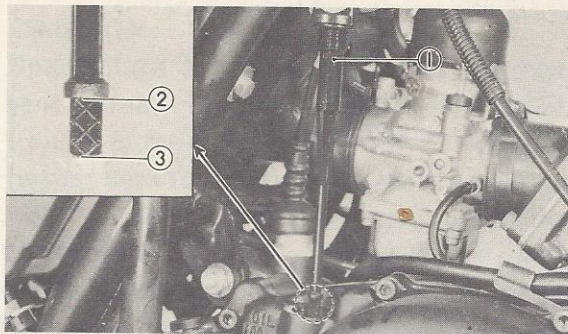

1. Dip stick
2. Maximum level
3. Minimum level

During the break-in period, you should replace the transmission oil 30 days or 400 km (250 mi.) after the date of purchase. The transmission should be drained and refilled approximately every 3,200 km. (2,000 mi.). On the bottom of the engine there is a drain plug. Remove it and drain all the transmission oil out.

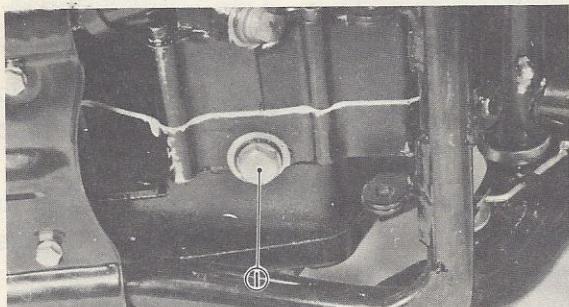

1. Drain plug

Reinstall the drain plug (make sure it is tight). Add oil through the dip stick hole.

**NOTE:**

Do not add any chemical additives. Transmission oil also lubricates the clutch and additives could cause the clutch to slip.

**Air filter**

The air filter protects the engine from dirt which can enter with the intake air and cause rapid engine wear. This dirt is filtered from the air by the air filter element.

1. Removal

a. Open the cover lock, and remove the air

filter case cap by removing the pan head screws(3).

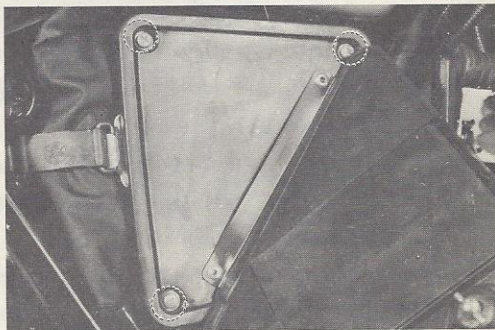

b. Pull out the element from its case, remove element from guide.

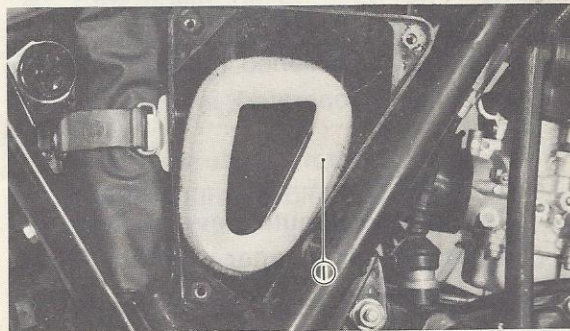

1. Air filter element



## 2. Cleaning method

Clean the element with solvent. After cleaning, remove the remaining solvent by squeezing the foam rubber. Then apply 30W motor oil to the entire surface and squeeze out the excess oil. Foam should be wet but not dripping. Coat the sealing edges of the filter element with light grease.

3. Reassemble by reversing the removal procedure. Check whether the element is seated completely against the case.

4. The air filter element should be cleaned once a month or every 1,600 km. (1,000 mi.).

It should be cleaned more often if the machine is operated in dusty or wet areas.

### CAUTION:

The engine should never be run without the air cleaner element installed; excessive piston and/or cylinder may result.

## Fuel petcock cleaning

1. First turn the petcock lever to "OFF" position, then remove the filter cup and the filter net. Clean the bottom of cup with solvent.
2. When reassembling, be careful not to clamp the filter cup too tightly as this may cause the O-ring to become unseated resulting in fuel leakage.

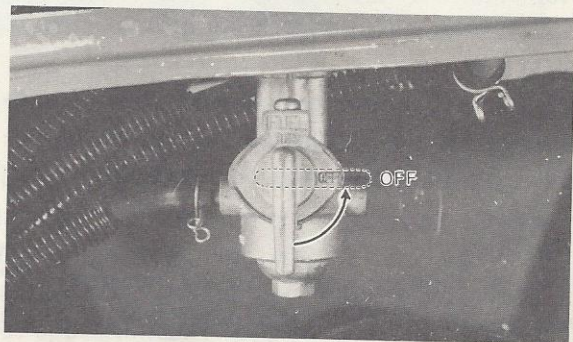

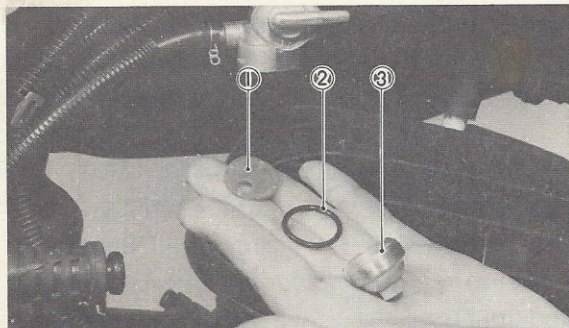

1. Filter screen    3. Filter cap  
2. O-ring

### Drive chain tension check

Inspect the drive chain with both tires touching the ground. Check the tension at the position shown in the illustration. The normal vertical deflection is approximately 40 ~ 50 mm. (1.6 ~ 2.0 in.). If the deflection exceeds 50 mm. (2.0 in.) adjust the chain tension.

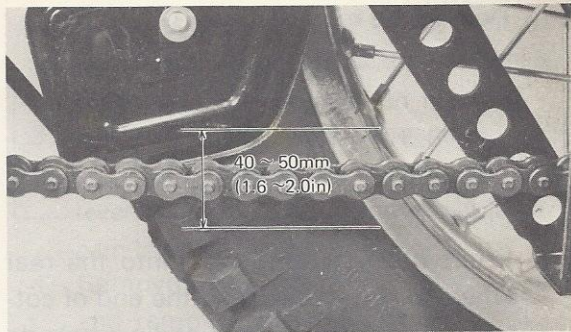

### Drive chain tension adjustment

1. Loosen the rear brake adjuster.
2. Remove the rear axle cotter pin.
3. Loosen the rear wheel axle nut.
4. Turn chain puller cam both left and right, until axle is situated in same cam slot position.

#### NOTE:

Before adjusting, rotate rear wheel through several revolutions and check tension several times to find the tightest point. Adjust chain tension with rear wheel in this "tight chain" position.



5. Tighten the rear axle nut.

Axle nut torque:

8.3 ~ 13.0 m-kg

(60 ~ 94 ft-lb)

6. Insert the new cotter pin into the rear wheel axle nut and bend the end of cotter pin. If the nut notch and pin hole do not match, tighten the nut slightly to match.
7. In the final step, adjust the play in the brake pedal.

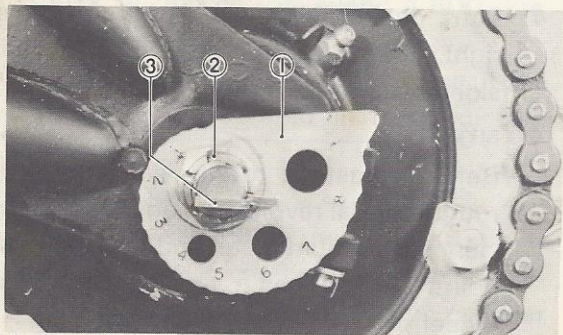

1. Chain puller cam 3. Cotter pin  
2. Axle nut

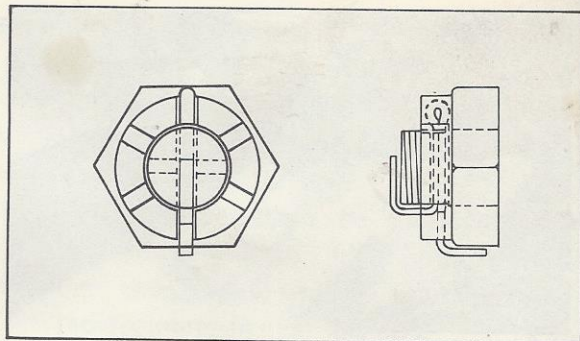

**NOTE:**

Excessive chain tension will overload the engine and other vital parts; keep the tension within the specified limits. Also, replace the rear axle cotter pin with a new one.

**Drive chain lubrication**

The chain consists of many parts which work against each other. If the chain is not maintained properly, it will wear out rapidly. Without lubrication the chain could wear out

very quickly. Therefore, form the habit of periodically servicing the chain. This service is especially necessary when driving in dusty conditions.

1. Use YAMAHA CHAIN/CABLE LUBE or any of the many brands of spray type chain lubricant. First, remove dirt and mud from the chain with a brush or cloth and then spray the lubricant between both rows of side plates and on all center rollers. This should be performed every 400 km. (250 mi.) or whenever the chain becomes dry.
2. To clean the entire chain, first remove the chain from the motorcycle, dip it in solvent and clean out as much dirt as possible. Then take the chain out of the solvent and dry it. After drying, lubricate the chain to prevent the formation of rust.

### Front wheel removal

1. Elevate the front wheel by placing a suitable stand under the engine.

2. Remove speedometer cable from front brake shoe plate: First remove clip and then pull cable out.
3. Remove brake cable: loosen all cable adjusters and remove cable from handle lever holder. Then remove cable from cam lever at front brake shoe plate.
4. Remove cotter pin from front wheel axle and remove axle nut.

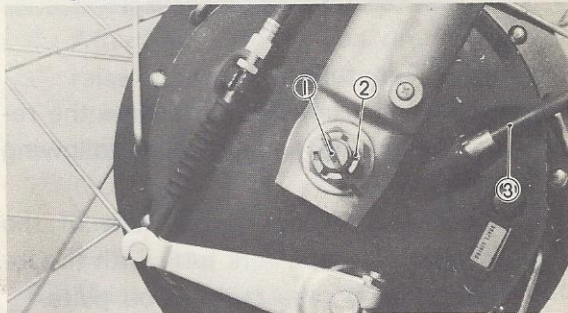

1. Cotter pin    2. Axle nut    3. Speedometer cable

5. Turn and pull out the front wheel axle; the wheel assembly can now be removed.
6. Loosen axle holder nuts at other end of axle.



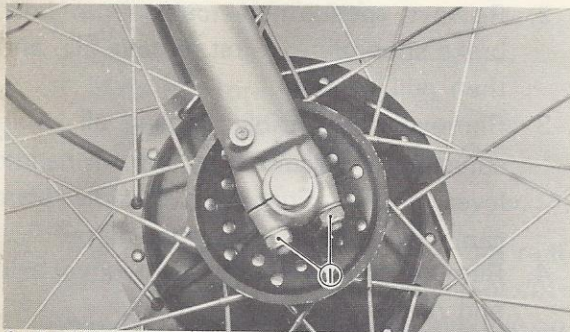

1. Axle holder nut

### Front wheel installation

When installing front wheel, reverse the removal procedure taking care of the following points:

1. Check for proper engagement of the boss on the outer fork tube with the locating slot on the brake shoe plate.

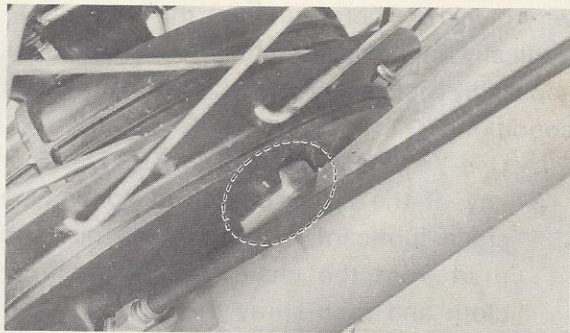

2. Always secure the front wheel axle as follows:
  - a) Torque the front axle nut.

Axle nut torque:  
7.0 ~ 10.0 m-kg.  
(50.6 ~ 72.3 ft-lb.)

- b) Install a new cotter pin; discard old pin.
  - c) Install the axle holder as shown. First tighten the nut on the front end of the axle holder, and tighten the nut on the rear end.

Axle holder nut torque:  
0.8 ~ 1.25 m-kg.  
(6.0 ~ 9.0 ft-lb.)

d) Adjust the play in the brake lever.

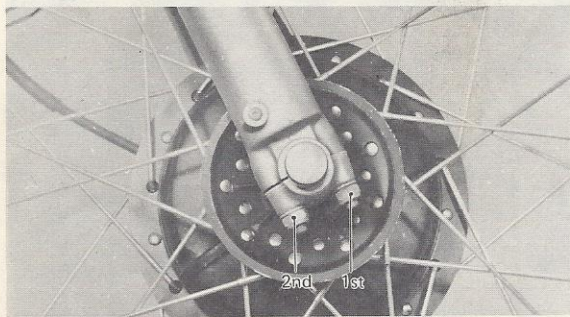

### Front fork oil change

1. Elevate front wheel by placing a suitable stand under the engine.
2. Remove cap bolts from inner fork tubes.
3. Remove drain screw from each outer tube with open container under each drain hole.

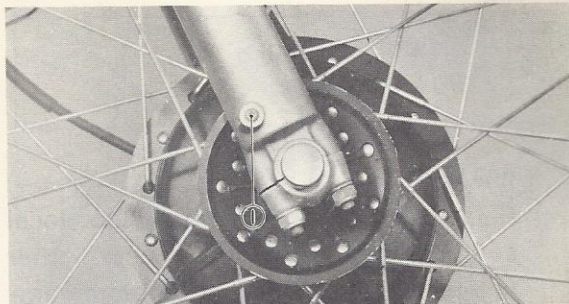

1. Drain screw

4. After most of oil has drained, slowly raise and lower outer tubes to pump out remaining oil.
5. Replace drain screws.

**NOTE:** \_\_\_\_\_  
Check gasket, replace if damaged.

6. Measure correct amount of oil and pour into each leg.

Recommended oil:  
Yamaha fork oil or  
SAE 10W/30



Quantity per leg:  
190.5 cc (6.4 oz)

**NOTE:** \_\_\_\_\_

Select the weight oil that suits local conditions and your preference (lighter for less damping; heavier for more damping).

\_\_\_\_\_

\_\_\_\_\_

7. After filling, slowly pump the outer tubes up and down to distribute the oil.

**NOTE:** \_\_\_\_\_

Adjust the oil levels in both right and left front forks so they are even.

\_\_\_\_\_

8. Inspect O-ring on fork cap bolts and replace if damaged.
9. Install the fork cap bolts and torque to specification.

Fork cap bolt torque:  
1.5 ~ 3.0 m·kg (10.8 ~ 21.7 ft·lb)

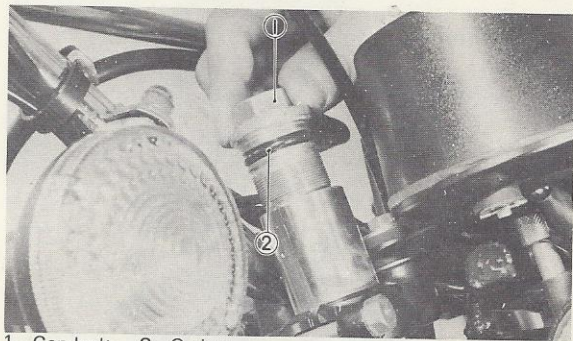

1. Cap bolt 2. O-ring

### Rear wheel removal

1. Elevate the rear wheel by placing a suitable stand under the engine.
2. Remove the brake adjuster and brake rod from the brake arm.
3. Remove the cotter pin from the axle nut and loosen the axle nut.

4. Remove the link clip and master link and remove the chain.
5. Remove the cotter pins (left and right). Then remove the clevis pins.
6. Pull the wheel backward, remove the rear wheel assembly.

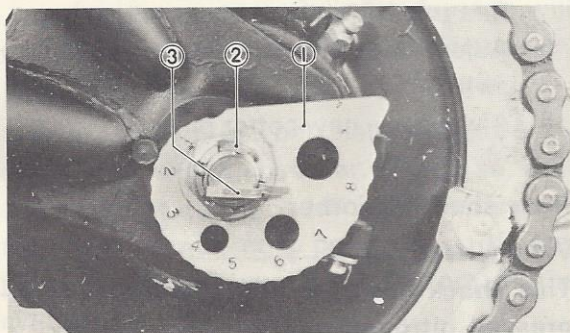

1. Chain puller cam
2. Axle nut
3. Cotter pin

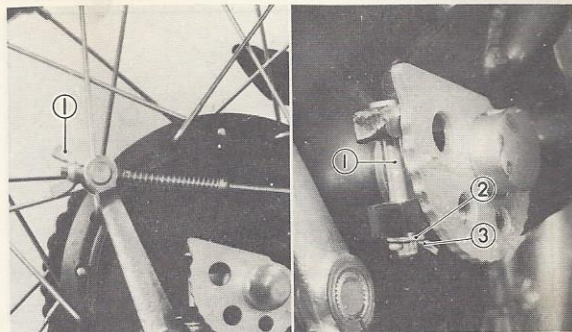

1. Adjustor

1. Clevis pin
2. Plain washer
3. Cotter pin

### Rear wheel installation

The rear wheel can be reassembled by reversing the disassembly procedure. Take care of the following points.

1. When connecting the chain, make certain closed end of master link clip is facing direction of rotation.



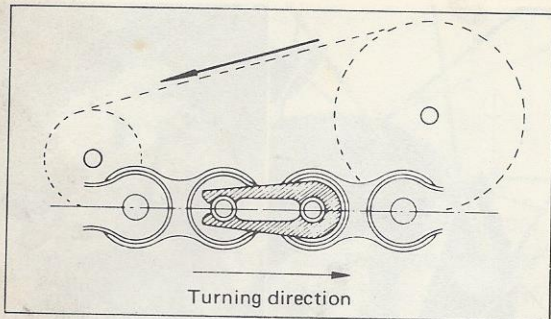

2. Check for proper engagement of the boss on swing arm with the locating slot on brake shoe plate.



3. Make sure the nut is properly torqued.

Tightening torque:  
8.3 ~ 13.0 m·kg (60 ~ 94 ft·lb)

4. Make sure to adjust the chain tension. See page 35 "Drive chain adjustment".
5. Adjust both brake pedal and stop light switch.
6. Always use new cotter pins.

### Rear shock absorber

#### WARNING:

This shock absorber contains highly compressed nitrogen gas.

Read and understand the following information before handling the shock absorber. The manufacture cannot be held responsible for property damage or personal injury that may result from improper handling.

1. Do not tamper or attempt to open the cylinder assembly.
2. Do not subject shock absorber to an open flame or other high heat. This may cause the unit to explode due to excessive gas pressure.
3. Do not deform or damaged the cylinder in any way. Cylinder damage will result in poor damping performance.

#### Notes on dispersal

Gas pressure must be released before disposing of shock absorber. To do so, drill a 2 ~ 3 mm (1/16 ~ 1/8 in) hole through the cylinder wall at a point 10 ~ 15 mm (2/5 ~ 3/5 in) above the bottom of the cylinder.

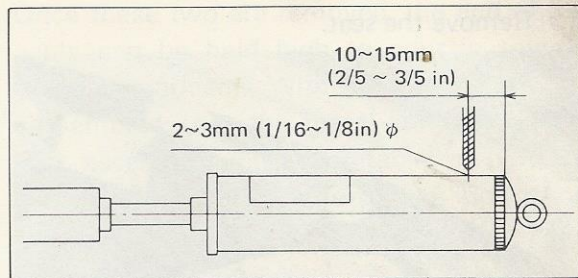

---

#### CAUTION:

Wear eye protection to prevent eye damage from escaping gas and /or metal chips.

---

#### Adjustment

The spring preload of the rear shock absorber can be adjusted to suit rider preference, weight and the course conditions. To adjust, use the ring nut wrench (provided) as shown. If the spring seat is raised, the spring becomes stiffer and if lowered the spring becomes softer.



1. Remove the seat.



2. Remove the spring seat stopper.



1. Stiffer
2. Softer
3. Spring seat stopper
4. Spring seat

3. Turn the spring seat in or out until adjustment is suitable.

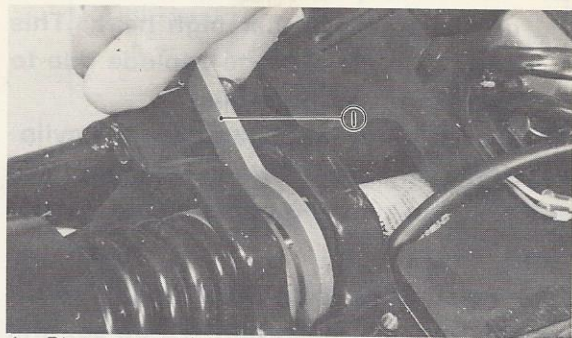

1. Ring nut wrench

4. Tighten the spring seat stopper.
5. Install the seat and tighten the securing bolt.

## Cable inspection and lubrication

1. Damage to the outer housing of the various cables, may cause corrosion and often free movement will be obstructed. An unsafe condition may result so replace as soon as possible.
2. If the inner cables do not operate smoothly, lubricate or ask your Yamaha dealer to replace them.

Recommended lubricant:  
YAMAHA CHAIN/CABLE LUBE  
or SAE 10W/30 type "SE"  
motor oil

## Throttle cable and grip lubrication

The throttle twist grip assembly should be greased at the time that the cable is lubricated, since the grip must be removed to get at the end of the throttle cable. Two screws clamp the throttle housing to the handlebar.

Once these two are removed, the end of the cable can be held high to pour in several drops of lubricant. With the throttle grip disassembled coat the metal surfaces of the grip assembly with a suitable all-purpose grease to cut down friction. (See lubrication chart)

## Lubrication of levers, pedals, etc.

1. Lubricate the pivoting parts of the brake and clutch levers with motor oil (10W/30).
2. Lubricate the shaft of the brake pedal with lithium soap grease.

## Steering inspection

Periodically inspect the condition of the steering. Worn out or loose steering bearings may be dangerous.



Place a block under the engine to raise the front wheel of the motorcycle off the ground; then hold the lower end of the front fork and try to move forward and backward. If any free play can be felt, ask a Yamaha dealer to inspect and adjust.

Inspection is easier if the front wheel is removed. Ask a dealer to lubricate the steering bearings every 5000 km (3000 mi.). More often in case of off road operation.

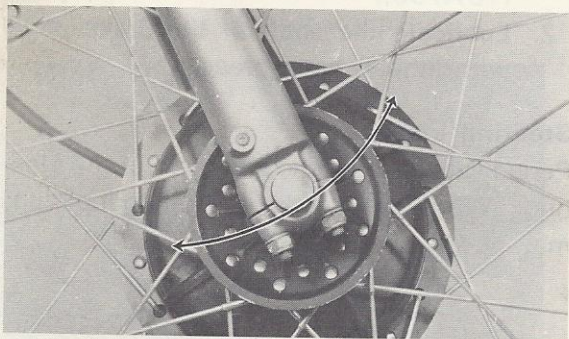

## Battery

Check the level of the battery fluid and see if the terminals are tight. Add distilled water if the fluid level is low.

### Replenishing the battery fluid

A poorly maintained battery will deteriorate quickly. The battery fluid should be checked at least once a month.

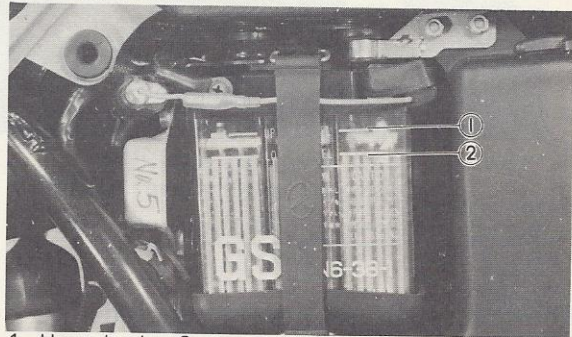

1. Upper level 2. Lower level

1. The level should be between the upper and lower level marks. Use only distilled water if refilling is necessary.

**NOTE:** \_\_\_\_\_

Normal tap water contains minerals which are harmful to a battery; therefore, refill only with distilled water.

2. When the motorcycle is not to be used for a month or longer, remove the battery and store it in a cool, dark place. Completely recharge the battery before reusing.
3. If the battery is to be stored for a longer period than the above, check the specific gravity of the fluid at least once a month and recharge the battery when it is too low.
4. Always make sure the connections are correct when putting the battery back in the motorcycle. The red lead is for the + terminal and the black lead is for the - terminal. Make sure the breather pipe is properly connected and is not damaged or obstructed.

**Fuse replacement**

If any fuse is blown, turn off the ignition switch and the switch in the circuit in question and install a new fuse of proper amperage.

Then turn on the switches, and see if the electrical device operates. If the fuse immediately blows again, consult your Yamaha dealer.

**CAUTION:** \_\_\_\_\_

**Do not use fuses of a higher amperage rating than those recommended.**

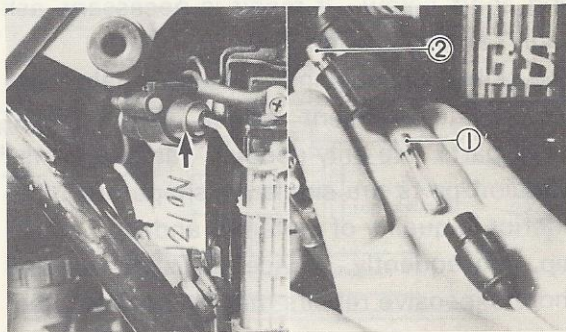

1. Fuse  
2. Spare fuse



## Replacing the headlight bulb

This motorcycle is equipped with a sealed beam headlight. If the headlight burns out, ask your Yamaha dealer for a lens unit replacement and adjustment.

## Troubleshooting

Although Yamaha motorcycles are given a rigid inspection before shipment from the factory, trouble may occur in operation. If this happens check the motorcycle in accordance with the procedures given in the troubleshooting chart below. If repair is necessary, ask your Yamaha dealer.

The skilled technicians at your Yamaha dealer provide excellent service. For replacement parts, use only genuine Yamaha Parts. Imitation parts are similar in shape but often inferior in quality of materials and workmanship, consequently, service life is shorter and more expensive repairs may be necessitated.

Any fault in the fuel, compression or ignition systems can cause poor starting or loss of power while riding. The troubleshooting chart describes quick and easy procedures for checking these systems.

## Troubleshooting chart

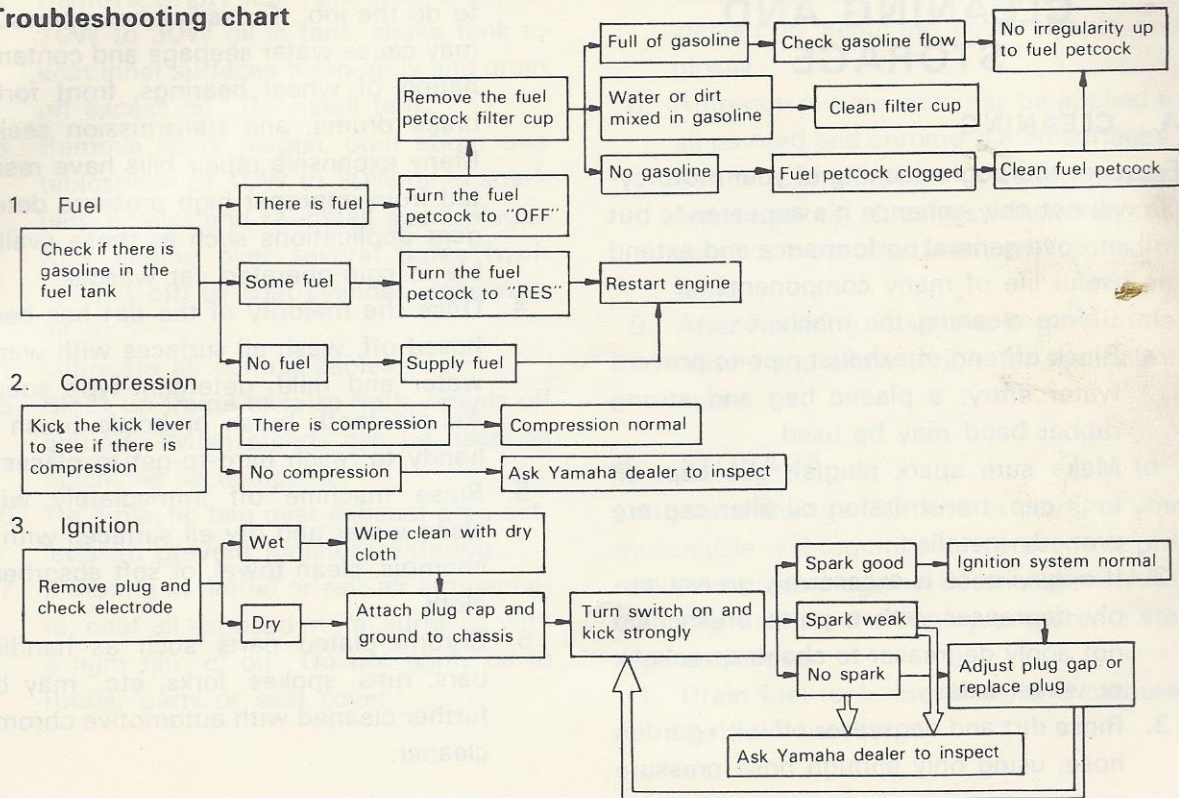



# CLEANING AND STORAGE

## A. CLEANING

Frequent thorough cleaning of your motorcycle will not only enhance its appearance but will improve general performance and extend the useful life of many components.

1. Before cleaning the machine:
  - a) Block off end of exhaust pipe to prevent water entry; a plastic bag and strong rubber band may be used.
  - b) Make sure spark plug(s), gas cap, oil tank cap, transmission oil filler cap are properly installed.
2. If engine case is excessively greasy, apply degreaser with a paint brush. Do not apply degreaser to chain, sprockets, or wheel axles.
3. Rinse dirt and degreaser off with garden hose, using only enough hose pressure to do the job. Excessive hose pressure may cause water seepage and contamination of wheel bearings, front forks, brake drums, and transmission seals. Many expensive repair bills have resulted from improper high pressure detergent applications such as those available in coin-operated car washes.
4. Once the majority of the dirt has been hosed off, wash all surfaces with warm water and mild, detergent-type soap. An old tooth brush or bottle brush is handy to reach hard-to-get-to places.
5. Rinse machine off immediately with clean water and dry all surfaces with a chamois, clean towel, or soft absorbent cloth.
6. Chrome-plated parts such as handlebars, rims, spokes, forks, etc., may be further cleaned with automotive chrome cleaner.

2. Remove empty fuel tank, pour a cup of 10W to 30W oil in tank, shake tank to coat inner surfaces thoroughly and drain off excess oil. Re-install tank.
3. Remove spark plug(s), pour about one tablespoon of 10W to 30W oil in spark plug hole(s) and re-install spark plugs. Kick engine over several times (with ignition off) to coat cylinder walls with oil.
4. Lubricate all control cables.
5. Block up frame to raise both wheels off ground. (Main stands can be used on machines so equipped.)
6. Tie a plastic bag over exhaust pipe outlet(s) to prevent moisture entering.
7. If storing in humid or salt-air atmosphere, coat all exposed metal surfaces with a light film of oil. Do not apply oil to rubber parts or seat cover.
7. Clean the seat with a vinyl upholstery cleaner to keep the cover pliable and glossy.
8. Automotive-type wax may be applied to all painted and chrome-plated surfaces. Avoid combination cleaner-waxes. Many contain abrasives which may mar paint or protective finish on fuel and oil tanks.
9. After finishing, start the engine immediately and allow to idle for several minutes.

## **B. STORAGE**

Long term storage (30 days or more) of your motorcycle will require some preventive procedures to insure against deterioration. After cleaning machine thoroughly, prepare for storage as follows:

1. Drain fuel tank, fuel lines, and carburetor float bowl(s).



Remove battery and charge. Store in a dry place and re-charge once a month. Do not store battery in an excessively warm or cold place (less than 0°C (32°F) or more than 30°C (90°F)).

**NOTE:** \_\_\_\_\_

Make any necessary repairs before storing the motorcycle.

---

# MISCELLANEOUS

## Consumer information

### STOPPING DISTANCE

This figure indicates braking performance that can be met or exceeded by the vehicles to which it applies, without locking the wheels, under different conditions of loading and with partial failures of the braking system. The information presented represents results obtainable by skilled drivers under controlled road and vehicle conditions and the information may not be correct under other conditions.

Description of vehicles to which this table applies: Yamaha motorcycle DT250D/DT400D

#### A. Fully Operational Service Brake

##### Load

Light

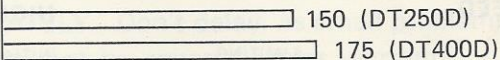

Maximum

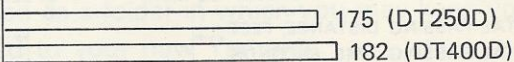

0      100      200      300

Stopping distance in feet from 60 mi/h



## ACCELERATION AND PASSING ABILITY

This figure indicates passing times and distances that can be met or exceeded by the vehicles to which it applies, in the situations diagrammed below.

The low-speed pass assumes an initial speed of 20 mi/h. and a limiting speed of 35 mi/h. The high-speed pass assumes an initial speed of 50 mi/h. and a limiting speed of 80 mi/h.

**NOTICE:** The information presented represents results obtainable by skilled drivers under controlled road and vehicle conditions, and the information may not be correct under other conditions.

Description of vehicles to which this table applies: Yamaha motorcycle DT250D/DT400D

Summary table

	DT250D	DT400D
Low-speed pass	360 feet: 7.4 seconds	352 feet: 7.2 seconds
High-speed pass	1,300 feet: 14.1 seconds	1,084 feet: 11.2 seconds

### LOW-SPEED

INITIAL  
SPEED: 20 mi/h.

LIMITING  
SPEED: 35 mi/h.

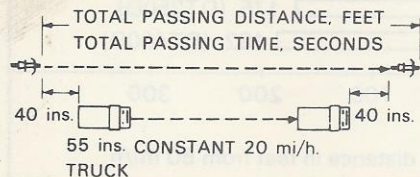

### HIGH-SPEED

INITIAL  
SPEED: 50 mi/h.

LIMITING  
SPEED: 80 mi/h.

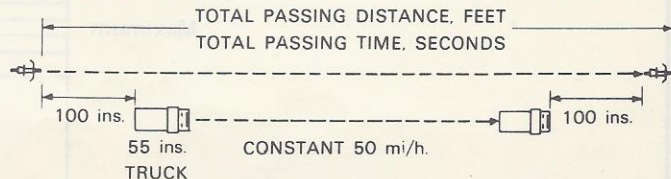

## WARRANTY INFORMATION

Please refer to your copy of the Yamaha Owner's Warranty Guide for details of the warranty offered on your new Yamaha.

The Warranty Guide contains the warranty policy, an explanation of the warranty, and other important information. Becoming familiar with these policies will be to your advantage in making the best use of Yamaha's warranty programs.

There are certain requirements which you must meet in order to qualify for warranty coverage. FIRST, your new Yamaha must be operated and maintained properly, as explained in this manual. If you have any questions about any procedure in this manual, please consult your dealer. ABUSE AND NEGLECTED MAINTENANCE MAY LEAD TO MECHANICAL FAILURES WHICH CANNOT BE COVERED UNDER WARRANTY.

SECOND, IF ANY PROBLEMS OCCUR WHICH YOU FEEL SHOULD BE COVERED UNDER WARRANTY, NOTIFY YOUR DEALER IMMEDIATELY. Don't delay, as small problems left unrepaired can become large problems which may not be covered under warranty.

We recommend that the Warranty Guide be used as a folder in which you may keep your registration and other important documents related to your new Yamaha.

- The Yamaha Owner's Warranty Guide is to be supplied by your Yamaha dealer at the time of purchase. If you did not receive one, or have lost yours, you may obtain extra copies upon request from your Yamaha dealer or by writing to:

**YAMAHA INTERNATIONAL CORPORATION**  
**P.O. Box 6600**  
**Buena Park, California 90620**  
**Attn: Warranty Department**



## SPECIFICATIONS

MODEL	DT250D	DT400D
<b>DIMENSION:</b>		
Overall length	2,185 mm (86.0 in.)	←
Overall width	870 mm (34.3 in.)	←
Overall height	1,165 mm (45.9 in.)	←
Wheelbase	1,420 mm (55.9 in.)	1,415 mm (55.7 in.)
Minimum road clearance	255 mm (10.0 in.)	←
<b>WEIGHT:</b>		
Net	118 kg (259.6 lb.)	122 kg (268.4 lb.)
<b>PERFORMANCE:</b>		
Minimum turning radius		2,200 mm (86.6 in.)
Climbing ability		35°
<b>ENGINE</b>		
Type	Air-cooled, 2-stroke, gasoline, Torque induction	←
Engine model	IMI	IM2
Cylinder	Single, Forward inclined	←
Displacement	246 cc (15.01 cu.in.)	397 cc (24.22 cu.in.)
Bore x Stroke	70 x 64 mm (2.756 x 2.520 in.)	85 x 70 mm (3.346 x 2.756 in.)
Compression ratio	6.7 : 1	6.4 : 1

MODEL	DT250D	DT400D
Starting system	Primary kick	←
Ignition system	Magneto	C.D.I.
Gasoline tank capacity	9 lit. (2.4 U.S. gal.)	←
Oil tank capacity	1.1 lit.(1.2 U.S. qt.)	←
Lubricating system	Separate lubrication (Yamaha Autolube)	←
<b>BATTERY:</b>		
Capacity	6V, 6AH	←
Type	6N6 - 3B - 1	←
Generator type	F00T0 4274	F008T00371
Spark plug	B-8ES (NGK)	←
Clutch type	Wet, multi-disc type	←
Carburetor	VM28SS	VM32SS
Air cleaner	Oiled, foam rubber	←
<b>TRANSMISSION:</b>		
Primary reduction system	Gear	←
Primary reduction ratio	65/23 2.826	←
Gear ratio 1st	33/13 2.538	38/14 2.714
2nd	34/19 1.789	34/19 1.789
3rd	26/20 1.300	26/20 1.300
4th	23/23 1.000	23/23 1.000
5th	20/26 0.769	20/26 0.769



MODEL	DT250D	DT400D
Secondary reduction system Secondary reduction ratio	Chain 47/14 3.357	← 43/16 2.688
<b>STEERING:</b> Caster Trail	60° 135 mm (5.31 in.)	← ←
<b>TIRE SIZE:</b> Front Rear		3.00-21-4PR 4.00-18-4PR
<b>SUSPENSION:</b> Front Rear		Telescopic fork Swing arm
<b>SHSHOCK ABSORBER:</b> Front Rear		Coil spring, oil damper Monocross suspension
<b>FRAME TYPE:</b>		Tubular, double cradle

MODEL	DT250D	DT400D
<b>ELECTRICAL:</b> Headlight Flasher light Tail/stop light Indicator light    TURN NEUTRAL OIL HIGH BEAM Meter lights		6V, 30W/30W 6V, 17W x 4 6V, 5.3W/25W 6V, 3W 6V, 3W 6V, 3W 6V, 3W 6V, 3W x 2



MEMO

MODEL	DESCRIPTION	REMARKS
ELECTRICAL	6V 30W	
FLUORESCENT LIGHT	6V 3W	
INTERNAL LIGHT	6V 3W	
NEUTRAL	6V 3W	
OIL	6V 3W	
HIGH BEAM	6V 3W	
WATER LIGHT	6V 3W x 2	

MEMO





SINCE 1887

**YAMAHA MOTOR CO., LTD.**

IWATA, JAPAN

LIT-11626-00-40

PRINTED IN JAPAN

76 · 4 - 4 1 1 1