



**YAMAHA**



**CS3-B**

**SERVICE MANUAL**

## FOREWORD

This manual is intended to provide vital technical service information to keep the CS3-B in good working condition. It is urged, therefore, that all YAMAHA dealers and mechanics become familiar with handling and servicing the CS3-B and thereby make their sales and service more efficient and profitable.

The CS3-B incorporates several of Yamaha's special engineering features, especially those just previously mentioned model changes. If you desire to acquaint yourself with more details concerning these items, since they are basically items found only on Yamaha's, then turn to Chapter 1...features section, Chapter 2 Autolube Chapter 3 for an explanation of 5-Port cylinders, or Chapter 4... section 4-5 (explanation of Keystone rings.) . . . .

YAMAHA MOTOR CO., LTD.  
SERVICE DEPARTMENT

# CONTENTS

## CHAPTER 1. GENERAL

1 - 1.	Features . . . . .	5
1 - 2.	Specifications . . . . .	6
1 - 3.	Performance Curves . . . . .	8
1 - 4.	Service Tools . . . . .	9

## CHAPTER 2. YAMAHA AUTOLUBE

2 - 1.	What is YAMAHA Autolube? . . . . .	11
2 - 2.	Features of YAMAHA Autolube . . . . .	11
2 - 3.	Handling the Oil Pump . . . . .	11

## CHAPTER 3. 5-PORT CYLINDERS

3 - 1.	Description of 5-Port Cylinder . . . . .	13
3 - 2.	Construction and Features . . . . .	13

## CHAPTER 4. ENGINE

4 - 1.	Removing the Engine . . . . .	14
4 - 2.	Cylinder Heads . . . . .	17
4 - 3.	Cylinders . . . . .	17
4 - 4.	Piston Pins . . . . .	19
4 - 5.	Piston Rings . . . . .	20
4 - 6.	Pistons . . . . .	22
4 - 7.	Crankcase Cover (R) . . . . .	24
4 - 8.	Tachometer Drive Gear Assembly . . . . .	25
4 - 9.	Clutch . . . . .	25
4 - 10.	Primary Drive Gear . . . . .	33
4 - 11.	Distance Collar . . . . .	34
4 - 12.	Kick Starter . . . . .	34
4 - 13.	Drive Sprocket . . . . .	36
4 - 14.	Shifting Mechanism . . . . .	38
4 - 15.	Splitting the Crankcase . . . . .	39
4 - 16.	Transmission Ass'y . . . . .	41
4 - 17.	Crankshaft . . . . .	42

4 - 18.	Bearings and Oil Seals .....	48
4 - 19.	Carburetors .....	49
4 - 20.	Air Cleaners .....	51

## CHAPTER 5. CHASSIS

5 - 1.	Front Wheel .....	53
5 - 2.	Rear Wheel .....	57
5 - 3.	Replacing Tires .....	59
5 - 4.	Rear Arm .....	59
5 - 5.	Fuel Tank .....	60
5 - 6.	Rear Sprocket Wheel .....	60
5 - 7.	Front Fork .....	61
5 - 8.	Rear Cushion .....	62

## CHAPTER 6. ELECTRICAL EQUIPMENT

6 - 1.	Electrical Equipment .....	63
6 - 2.	Main Components .....	63
6 - 3.	Connection Diagram .....	64
6 - 4.	Electrical Parts List .....	64
6 - 5.	Starter Dynamo .....	65
6 - 6.	<i>Regulator</i> (Voltage Regulator) .....	71
6 - 7.	Ignition Coil .....	73
6 - 8.	Spark Plugs .....	73
6 - 9.	Battery .....	74

---

## CHARTER I. GENERAL

### I - I. Features

#### 1. Autolube

The Autolube Injection System, pioneered by Yamaha, assures extra reliability and durability for the engine. With Autolube the necessity for mixing oil and gasoline, as in other 2-stroke machines, is no longer necessary.

#### 2. Five-Port Cylinders

The CS3-B is a 200cc parallel twin incorporating five-port aluminum cylinders. Five-port design, pioneered by Yamaha, has resulted in faster acceleration and more reliable performance due to more efficient breathing characteristics within the combustion chamber of the engine.

#### 3. Close-ratio Five Speed Transmission

The close-ratio transmission is designed to meet every requirement of street, highway and off-the-road travel. The transmission design allows for less engine strain for given engine loads. This will result in longer engine life.

#### 4. Primary Kick Starter

A primary kick starter permits the rider to start his machine without shifting gears to neutral. This is a most welcome convenience to the rider who happens to stall his machine, for example, in the midst of heavy traffic.

#### 5. Starter Jets

The built-in mixture enrichening jet, the Starter Jet, which is design feature on all Yamaha carburetors, permits quick starts even in the coldest weather.

#### 6. Waterproof/Dustproof Brakes

The front wheel brake is a double-leading shoe type very suitable for high speed braking. The design of the brakes, assemblies both front and rear, excellently seals out dust and water.

## GENERAL - Specifications & Performance

### I-2. Specifications & Performance

The following data subject to change without notice.

Model	CS3-B
Dimensions:	
Overall length	1,930 mm (76.0 in.)
Overall width	815 mm (32.1 in.)
Overall height	1,020 mm (40.2 in.)
Wheelbase	1,245 mm (49.0 in.)
Min. ground clearance	175 mm (6.9 in.)
Weight:	
Net	119 kg (262 lbs.)
Gross	130 kg (287 lbs.)
Performance:	
Max. speed	135 km/h plus (85 mph plus)
Fuel consumption (on paved level road)	50 km/liter at 40 km/h (117.6 mpg at 25 mph)
Climbing capacity	25 degrees
Min. turning radius	2,050 mm (80.7 in.)
Braking distance	11 m at 50 km/h (36.0 ft at 31 mph)
Acceleration performance (SS ¼ mile)	16.0 seconds
Engine:	
Type	CS3-B, 2 stroke, air cooled.
Cylinder	Two in parallel, forward inclined, 5 port.
Lubrication system	Separate lubrication (Yamaha Autolube)
Displacement	195 cc (11.89 cu. in.)
Compression ratio	6.2 : 1
Max. output	22 HP/7,500 rpm
Max. torque	2.17 kg-m/7,000 rpm (15.7 ft. lbs/7,000 rpm)
Starting system	Electric & kick starter
Ignition system	Battery ignition
Carburetor:	VM20SC x 2
Air cleaner:	Dry, paper filter
Transmission:	
Clutch	Wet, multi-disc
Primary reduction system	Helical gear
Primary reduction ratio	3.313 (53/16)

## GENERAL - Specifications & Performance

Gear box:	
Type	Constant mesh, 5 speed forward
Reduction ratio 1st	2.833 (34/12), Total reduction ratio—26.843
Reduction ratio 2nd	1.875 (30/16), Total reduction ratio—17.766
Reduction ratio 3rd	1.421 (27/19), Total reduction ratio—13.464
Reduction ratio 4th	1.045 (23/22), Total reduction ratio— 9.902
Reduction ratio 5th	0.840 (21/25), Total reduction ratio— 7.959
Secondary reduction system	Chain
Secondary reduction ratio	2.860 (40/14)
Chassis:	
Type of frame	Steel tubing, diamond structure
Suspension system, front	Telescopic fork
Suspension system, rear	Swing arm
Cushion system, front	Coil spring, oil damper
Cushion system, rear	Coil spring, oil damper
Steering system:	
Steering angle	42 degrees both right and left
Caster	64.0 degrees
Trail	90 mm (3.5 in)
Braking system:	
Type	Internalexpansion
Operation method, front	Right hand operation, cable actuated.
Operation method, rear	Right foot operation, rod actuated.
Tire size:	
Front tire	2.75—18—4PR
Rear tire	3.00—18—4PR
Tank capacity:	
Fuel tank capacity	9.0 liters (2.4 US glas.)
Oil tank capacity	1.9 liters (2.0 US qts.)
Generator:	
Model	CD—HR, GS214
Manufacturer	Mitsubishi Elec., Hitachi
Spark plug:	B—9HC
Battery:	
Model	12N9—3A—1
Capacity	12 V 9 AH
Lights:	
Headlight	12 V 35 W/25 W
Taillight	12 V 7 W
Stop light	12 V 23 W
Flasher lights	12 V 27 W
Neutral light	12 V 3 W
Meter lights	12 V 3 W x 2
High beam indicator light	12 V 1.5 W
Charging light	12 V 3 W
Flasher pilot light	12 V 3 W

I-3. Performance Curves

ENGINE PERFORMANCE CURVES

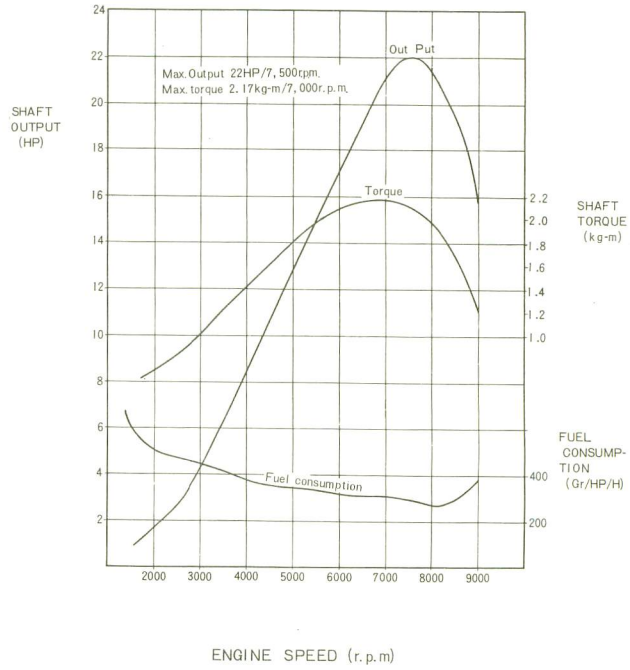

RUNNING PERFORMANCE CURVES

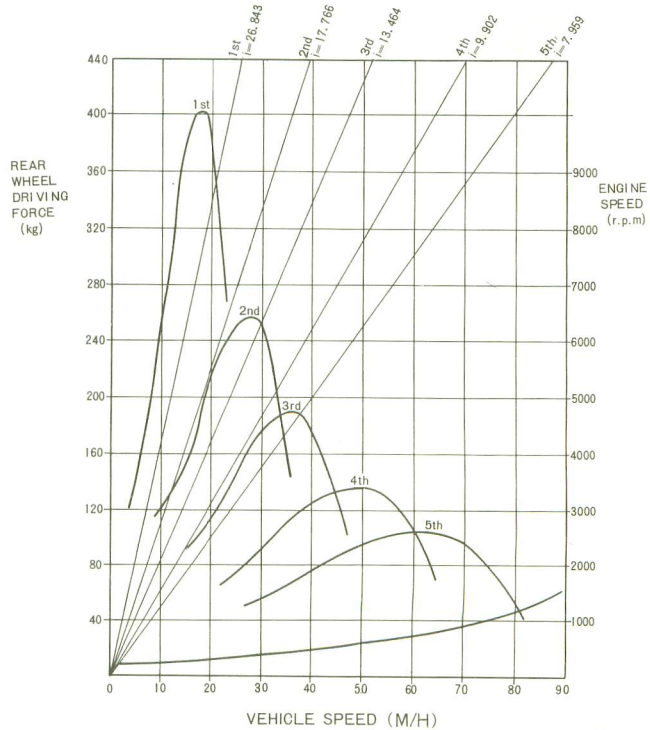



## I-4. Service Tools

The following tools and instruments are required for shop servicing the YAMAHA 200 CS3-B

### 1. Standard Tools

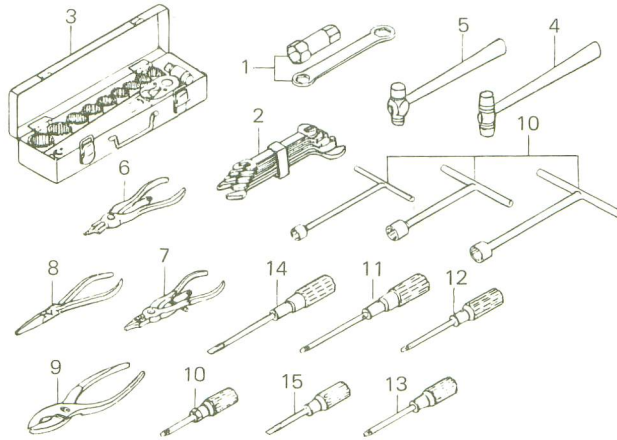

Fig. 1-4-1 ,

- |                             |  |
|-----------------------------|--|
| 1. Plug wrench 23 x 29mm    | 9. Pliers                              |
| 2. Set of spanners          | 10. Phillips-head screwdriver          |
| 3. Set of socket wrenches   | 11. Phillips-head screwdriver (large)  |
| 4. Soft-faced hammer        | 12. Phillips-head screwdriver (medium) |
| 5. Steel hammer             | 13. Phillips-head screwdriver (small)  |
| 6. Circlip pliers (ST type) | 14. Slot-head screwdriver (medium)     |
| 7. Circlip pliers (RT type) | 15. Slot-head screwdriver (small)      |
| 8. Needle nose pliers       | 16. T-type socket wrench               |

### 2. Special Tools

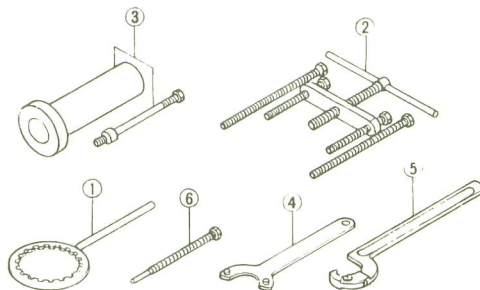
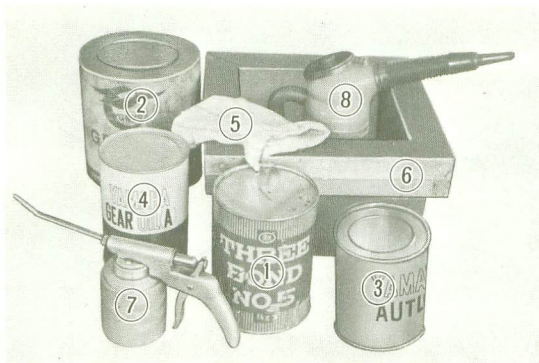

Fig. 1-4-2

1. Clutch holding tool
2. Crankcase dividing tool
3. Crankshaft installing tool
4. Flywheel magneto holding tool
5. New type exhaust ring nut wrench
6. Mitsubishi armature removing tool

in addition, an electro-tester, tachometer (engine speedmeter), hydrometer, gravimeter etc. are required.

### 3. Other Miscellaneous Tools



1. Grease
2. Autolube oil
3. YAMAHA Bond (No. 5)
4. Wiping materials
5. Overhauling stand
6. Gear oil
7. Oiler
8. Oil jug

Fig. 1-4-3

Using a wooden box will facilitate engine service. Expendable parts (such as gaskets) and replacement also be on hand.

## CHAPTER 2. YAMAHA AUTOLUBE

### 2-1. What is YAMAHA Autolube?

The YAMAHA Autolube is an automatic lubricating device for 2-stroke engines. Developed by the YAMAHA Technical Institute, it meters oil to the engine with respect to engine speed and throttle opening by means of a precision pump. As a result, the YAMAHA engine does not require premixed gas and oil like other 2-stroke engines. Controlled lubrication is automatically applied to the working parts of the engine. This makes YAMAHA Autolube the best lubricating system ever-devised for 2-stroke engines. The oil pump is driven by the engine, through a reduction gear system and is also connected to the throttle.

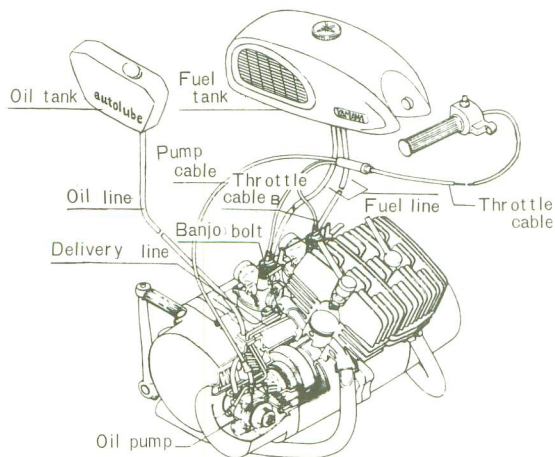

YAMAHA Autolube

Fig. 2-1-1

### 2-2. Features YAMAHA Autolube

YAMAHA Autolube:

1. Eliminates the bother of pre-mixing gas and oil.
2. Maintains optimum lubrication according to both engine speed and throttle opening.
3. Reduces spark plug fouling by injecting just enough oil for proper lubrication.
4. Cuts oil consumption to 1/3 that of conventional 2-stroke engines.
5. Reduces exhaust smoke.
6. Lets you use the engine compression as a brake; the oil injection system continues to operate according to engine RPM, even though the throttle may be closed.

7. Improves performance; no excess oil to interfere with complete combustion of the gas-air mixture.
8. Prolongs engine life; each injection is clean undiluted oil with high film strength, qualities often lacking in 2-stroke oils.

### 2-3. Handling the Oil Pump

The oil pump is a precision-machined assembly. Make no attempt to disassemble it. When you remove the oil pump from the engine, protect it from dust, dirt, etc. After reinstallation, be sure to bleed and test the pump correctly. Proper handling will keep the pump free from trouble.

#### 1. Bleeding

When the oil pump has been removed (the oil line is disconnected), or when the oil tank is empty (e.g., a brand new machine), air enters the pump case, and interrupts the flow of oil, so the pump must be bled.

Remove the bleeder bolt, and rotate the starter plate (manual feed wheel) clock wise to feed oil through the pump. Hold the adjusting pulley back (pull the pump cable) to let the plunger pump at maximum stroke. As you turn the starter plate, oil will begin flowing out of the bleeder hole. When air bubbles no longer appear in the oil, you can install and tighten the bleeder bolt. (Fig. 2-3-1)

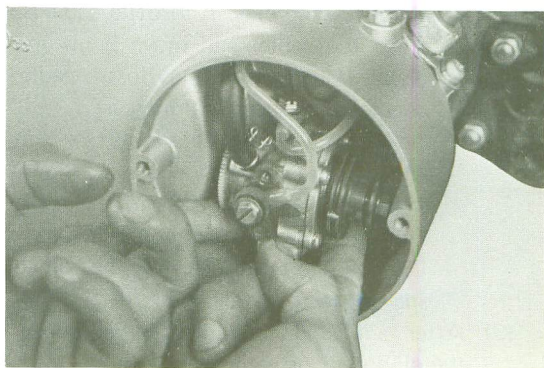

Fig. 2-3-1

## 2. Setting the Carburetor and Pump

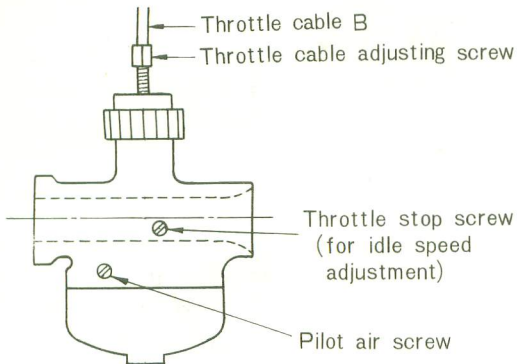

Fig. 2-3-2

- (1) Start the engine and warm it up, then set the idle speed between 1,050 rpm and 1,200 rpm.

- a. Be sure the pilot air screw on each carburetor is backed off 2 turns from a lightly seated position.

- (2) Adjust the throttle valves so that they lift simultaneously.

- a. Remove all slack from the throttle cables B.

Adjust the throttle cables B with the throttle cable adjusting screw. (Fig. 2-3-2)

To check the play in throttle cable B, grasp the cable, and move it up and down. If there is no play in the cable, engine idling speed will increase.

Adjust both throttle valves so that they function simultaneously.

- b. Adjust the play of the throttle cable connected to the handle grip to 0.5 ~ 0.1 mm. Do this by turning the adjusting nut to the cable guide. (Fig. 2-3-3)

- (3) After adjusting the throttle cable, set the oil pump correctly.

- a. Slowly open the handle grip until the play of the throttle cable is removed. (When the play is reduced to zero, the grip becomes somewhat tight). Adjust the pump cable so that the mark on the adjusting pulley is aligned with the guide pin. (Fig. 2-3-4)

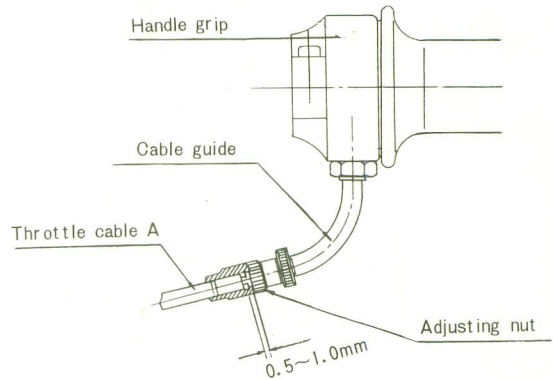

Fig. 2-3-3

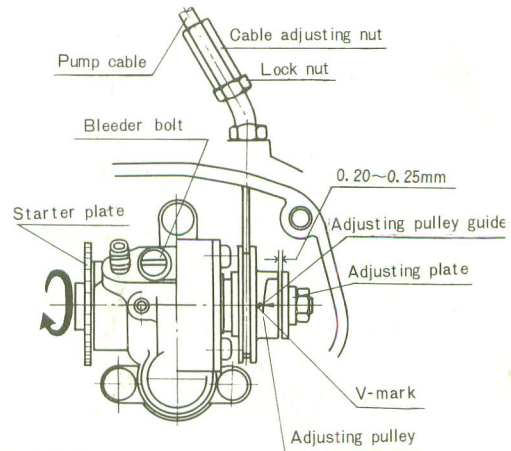

Fig. 2-3-4

- (4) Checking Minimum Pump (Plunger) Stroke.

- a. Stop the engine.
- b. Fully close the accelerator grip.
- c. Turn the oil pump starter plate in the direction of the arrow (marked on the starter plate) until the plunger moves to the end of its stroke. Then measure the narrowest gap between the adjusting pulley and the adjusting plate, using a feeler gauge.

- d. Correct Standards:

Minimum stroke limit 0.15mm

Proper tolerances 0.20-0.25mm

If the adjusting plate-to-pulley clearance is less than the minimum allowable stroke, remove the adjusting plate and install a 0.1mm adjusting shim or shims to obtain correct clearance.

## CHAPTER 3. 5-PORT CYLINDERS

### 3-1. Description of 5-Port Cylinder

The Schnuerle loop scavenging system is the most commonly used induction system for two-stroke engines. In the schnuerle loop system, transfer ports on the right and left sides of the cylinder are employed to transfer 2 streams of fresh fuel in the loop design that had proved to be the most effective induction system until the innovation of Yamaha's five-port cylinder. This conventional schnuerle loop system had a design limit in that the transfer ports could not be made large enough to completely clear the combustion chamber of exhaust gases because of the position of the intake and exhaust ports. This would result in a portion of exhaust gas remaining in the central area of the combustion chamber that would contaminate the fresh fuel charge.

The rotary valve induction system incorporates the use of a 3rd transfer port at the back of the cylinder that directs a fresh fuel charge to the dead area containing the remaining exhaust gases. But to incorporate the rotary valve system causes excessive engine width and unattractive appearance which restricts such an engine design.

Yamaha's Research and Engineering Departments, therefore, designed and perfected the five-port cylinder induction system that is used on the CS3-B. This new five-port system with the incorporation of two additional specially designed transfer ports completely removes all the exhaust gases previously left in the dead area of the cylinder.

### 3-2. Construction and Features

(Refer to Figs. 3-2-1, 2 and 3)

The 5-port cylinder induction system is similar to the Schnuerle loop scavenging system in that the two main streams (a) of fresh fuel meet at the cylinder wall opposite the exhaust ports, and deflect upward. Then, the streams again deflect downward, forcing out the burnt gases through the exhaust ports.

Additionally, in the 5-port cylinder induction system, two auxiliary transfer passages are so arranged that these two ports run from the bottom of the cylinder up to the same height as the main transfer ports. Therefore, when the piston comes down to bottom dead center, these two transfer passages are opened and fuel is pushed up from the crankcase to the cylinder through the two holes in the piston.

In the conventional Schnuerle system of porting, the burnt gases (b) cannot be completely cleared out of the cylinder, remaining in the center of the combustion chamber as shown in Fig. 3-2-1. However, the design of the 5-port cylinder induction system has successfully eliminated such a disadvantage; the additional ports are gases, completely forcing the exhaust gases out of the cylinder.

Another advantage of the 5-port induction system is that the piston is cooled by the exhaust gases passing through it. This greatly increases the engine power in combination with the new design of 5-porting system.

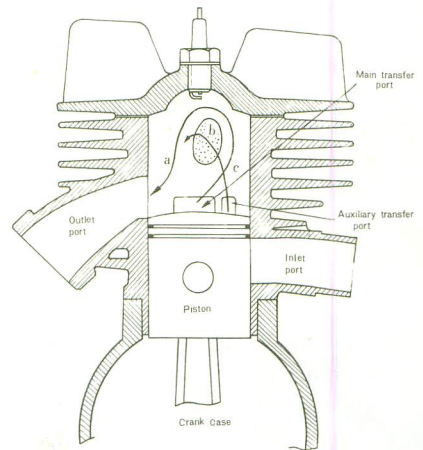

Fig. 3-2-1

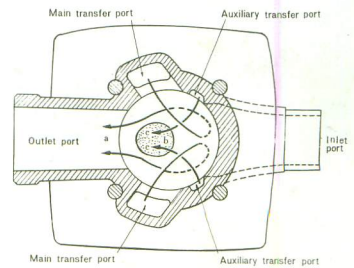

Fig. 3-2-2

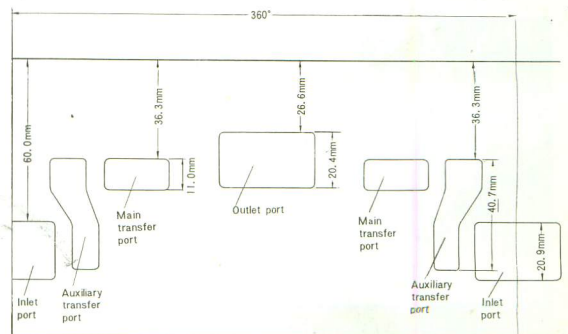

Fig. 3-2-3 5-port Cylinder Exploded View

## CHAPTER 4. ENGINE

The engine should be disassembled and reassembled in an orderly sequence to make your work easier and more efficient. The procedures outlined here are "examples", not inflexible rules for all repair jobs.

Coution on Engine Disassembling:

- Before removing the engine, clean the dirt and dust from the cylinder heads, cylinders and crankcase in order to keep these parts clean inside during disassembly and reassembly.
- Always use clean tools and use them correctly to avoid damaging parts.
- Keep disassembled parts in the parts trays and in separate groups or sub-assemblies so that no parts will be misplaced.

### 4-1. Removing the Engine

1. Warm up the engine for a few minutes, and drain the transmission oil. (Fig. 4-1-2) Amount of transmission oil:

800-900cc (0.85 US qts.) (YAMAHA gear oil SAE 10W/30 should be used.)

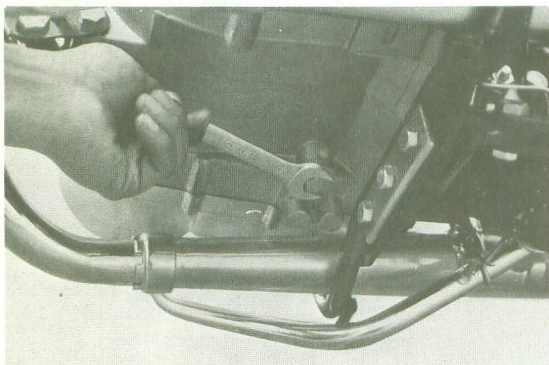

Fig. 4-1-2

2. Remove the mufflers and exhaust pipes. (Fig. 4-1-3)

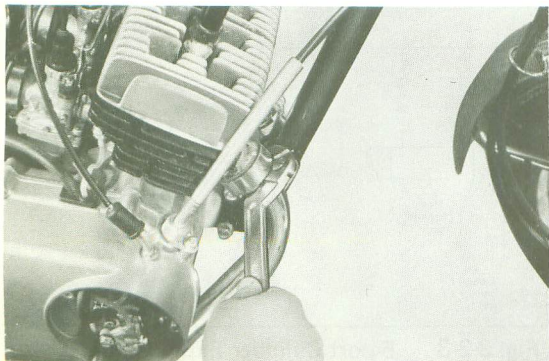

Fig. 4-1-3

3. Remove the foot rest, change pedal and crankcase cover (L) (Fig. 4-1-4)

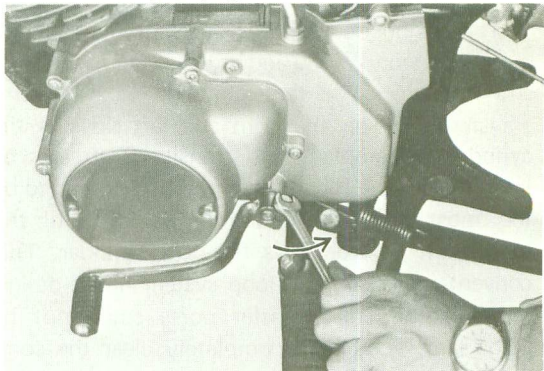

Fig. 4-1-4

4. Remove the dynamo. (Remove the wire harness).

(1) Remove the crankcase cover (L)

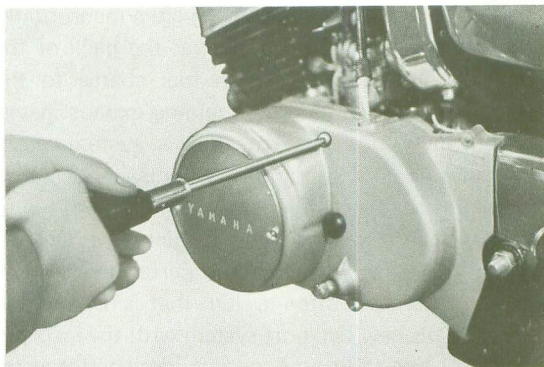

Fig. 4-1-5

(2) Remove the wire harness (Fig. 5-1-6)

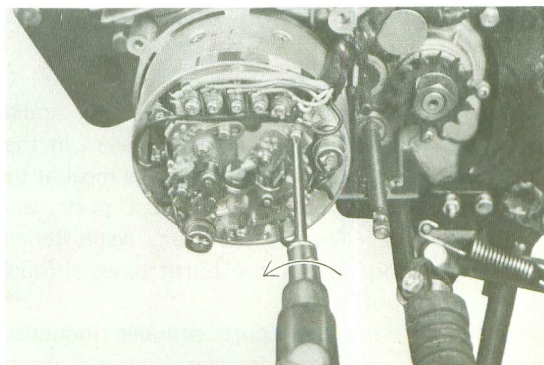

Fig. 4-1-6

(3) Remove the governor. (Fig. 4-1-7)

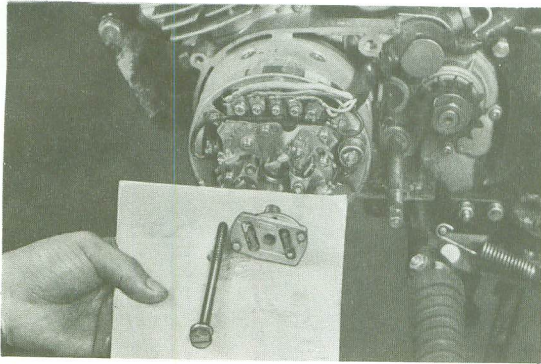

Fig. 4-1-7

(4) Remove the yoke ass'y (Fig. 4-1-8)

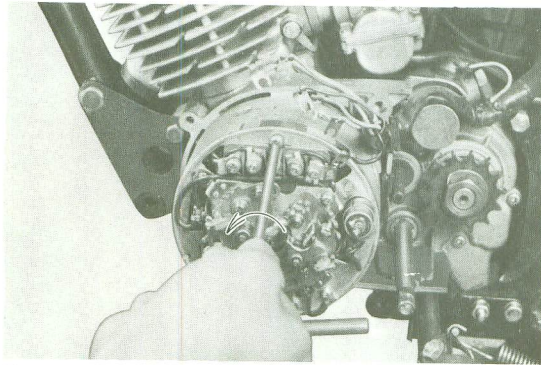

Fig. 4-1-8

(5) Remove the armature by the use of the armature puller bolt. (Fig. 4-1-9)

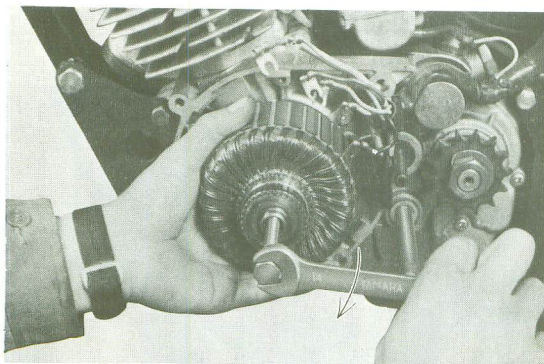

Fig. 4-1-9

6. Remove the carburetor throttle valves. (Fig. 4-1-10)

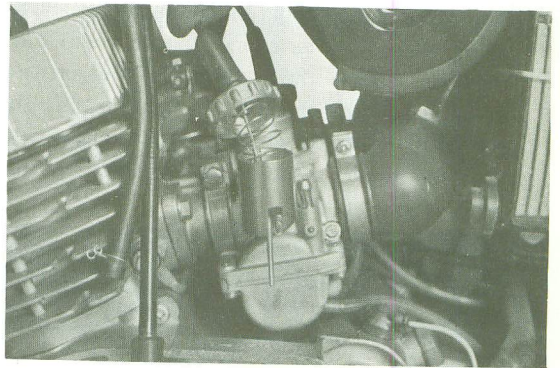

Fig. 4-1-10

7. Remove the air cleaner rubbers. (Fig. 4-1-11)

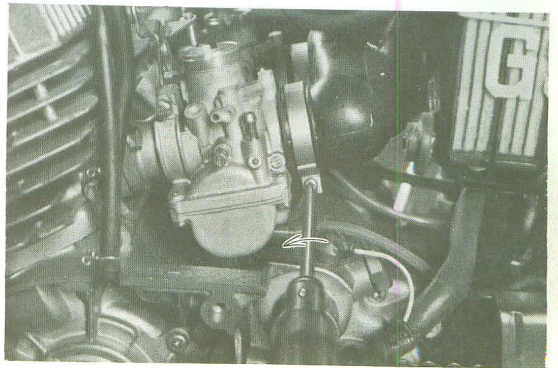

Fig. 4-1-11

8. Remove the neutral light wiring. (Fig. 4-1-12)

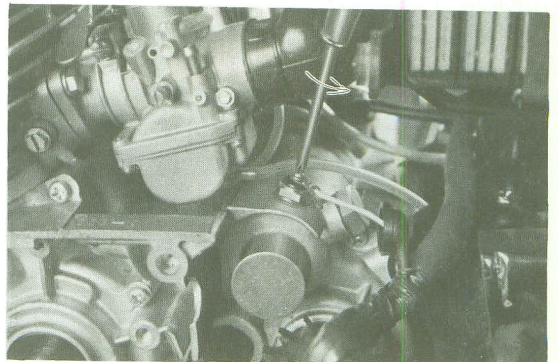

Fig. 4-1-12

## ENGINE - Removing the Engine

9. Remove the chain at the master link.  
(Fig. 4-1-13)

The drive chain should be connected as shown in Fig. 4-1-14. After connecting the chain, have the rider sit on the motorcycle. Measure the up-and-down movement of the chain at the center of the lower chain run, and adjust it so that the total up-and-down movement of the chain is about 0,8 in. (20mm).

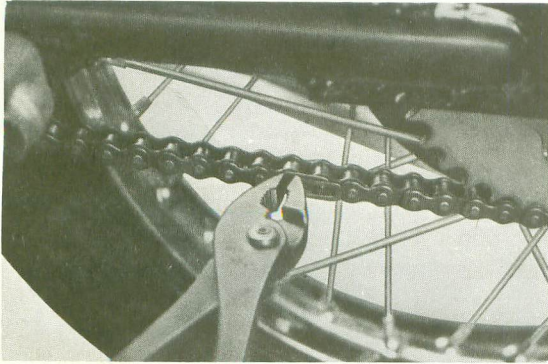

Fig. 4-1-13

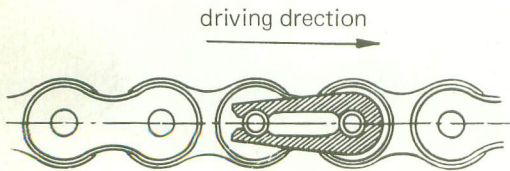

Fig. 4-1-14

10. Disconnect the oil line from the oil tank bottom. (Fig. 4-1-15)  
Install a plug in the oil tank outlet to prevent oil from flowing out.

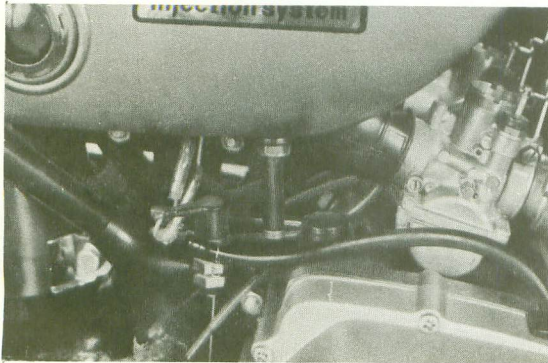

Fig. 4-1-15

11. Remove the oil pump cable.  
(Fig. 4-1-16)

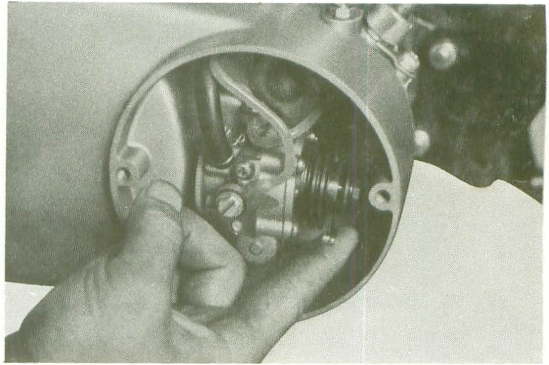

Fig. 4-1-16

12. Remove the tachometer cable.  
(Fig. 4-1-17)

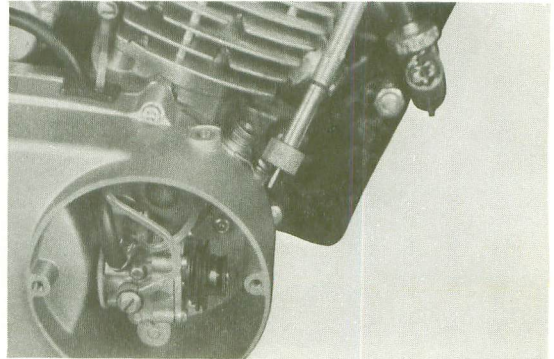

Fig. 4-1-7

- 13 Remove the engine mounting bolts, and remove the engine from the chassis.  
(Fig. 4-1-18)

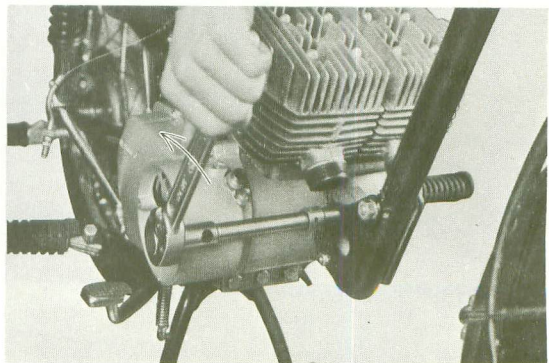

Fig. 4-1-18



## 4-2. Cylinder Heads

### 1. Removal and Reinstallation

Remove the carburetors (Fig. 4-2-1)

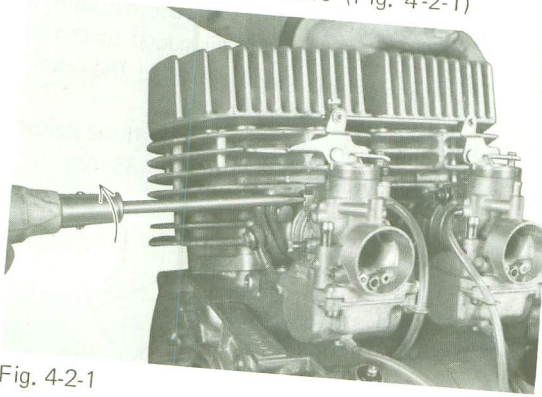

Fig. 4-2-1

Remove the nuts on the four cylinder stud bolts, (Fig. 4-2-2) then remove the cylinder head and cylinder head gasket. (Fig. 4-2-3)

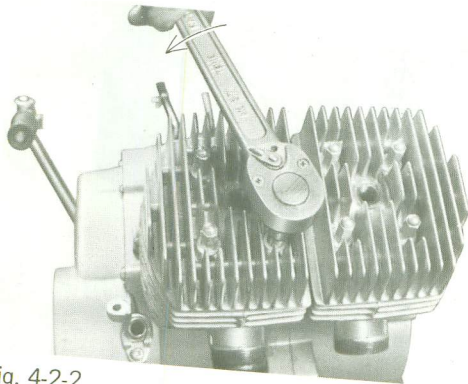

Fig. 4-2-2

**NOTE:** As soon as the cylinders have been lifted high enough, stuff clean rags beneath the pistons to prevent dirt or contamination from falling into the engine. If the gaskets are damaged or defective, replace them.

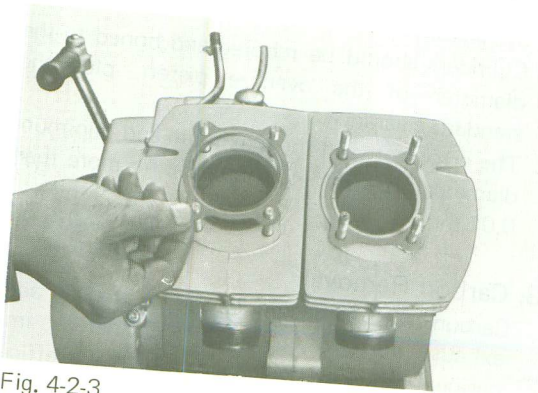

Fig. 4-2-3

Remove the Banjo bolts. (Fig. 4-2-4)

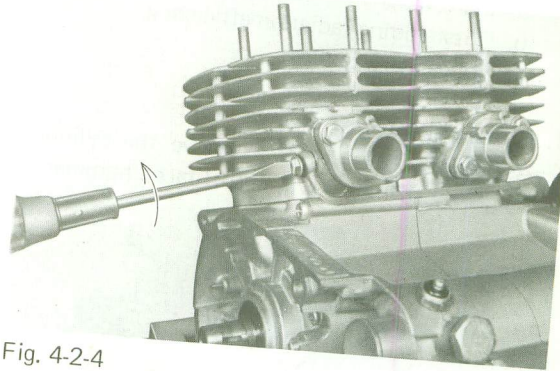

Fig. 4-2-4

### 2. Removing Carbon

Carbon accumulation inside the cylinder head results in pre-ignition, overheating, and excessive fuel consumption, so scrape the cylinder head clean. (Fig. 4-2-5)

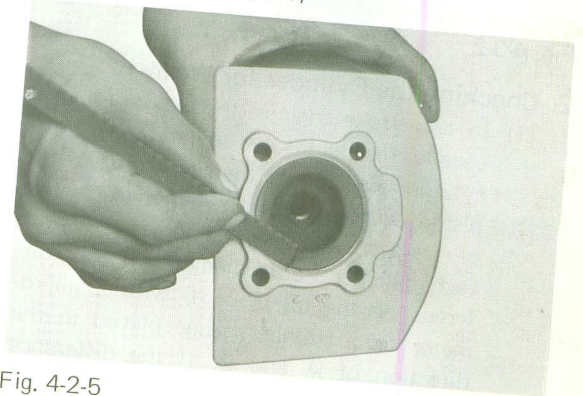

Fig. 4-2-5

## 4-3. Cylinders

The engine is provided with aluminum cylinders, to which special cast iron sleeves are bonded by means of a metallic bond process. As a result, the new type of cylinder is free from various troubles such as the separation of the liner from the cylinder barrel due to the difference in expansion coefficient between the two metals, and piston burning resulting from a decrease in heat radiation efficiency.

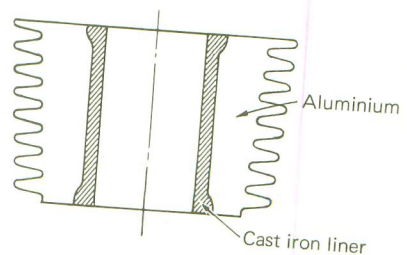

Fig. 4-3-1

The YAMAHA aluminum cylinder features:

- a. Light weight
- b. Outstanding radiation efficiency.
- c. Longer service life.

### 1. Removal

As shown in Fig. 4-3-2, remove the cylinder by gently striking it with a soft-faced hammer.

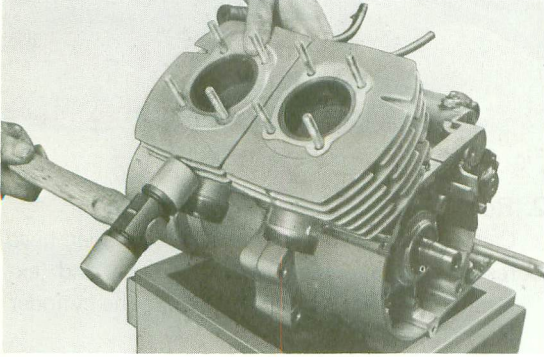

Fig. 4-3-2

### 2. Checking the Cylinder for Wear

(1) In two-stroke engines, the maximum wear usually results in the upper area of the cylinder wall due to the side thrust of the piston, with less wear in the adjacent areas of transfer and exhaust ports. Measure each cylinder's bore diameter at four different depths (a, b, c, d) with a micrometer or a cylinder gauge placed in the direction of A and B. If the difference between the maximum and minimum diameters measured exceeds 0.05mm (0.0019 in.), rebore and hone the cylinder. (Figs. 4-3-3 and 4)

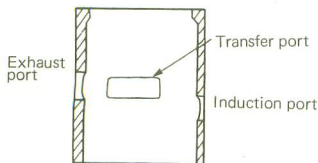

Fig. 4-3-3

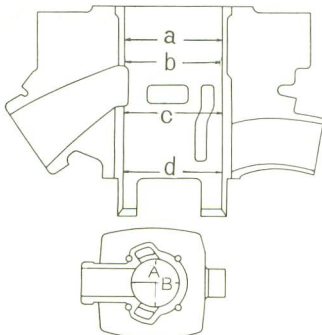

Fig. 4-3-4

(2) To make sure that the cylinder boring has been correctly done, measurements should be made as illustrated below.

Measure each cylinder's bore diameter at four different depths (a,b,c,d) with a micrometer or a cylinder gauge placed at right angles and then parallel to the crankshaft (A and B). (Fig. 4-3-5)

The minimum clearance between the piston and the cylinder is 0.030 to 0.035 mm.

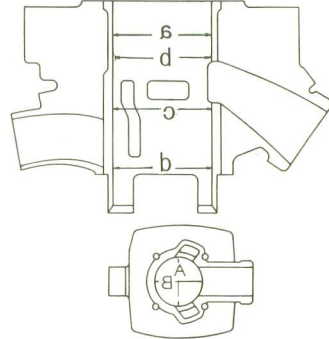

Fig. 4-3-5

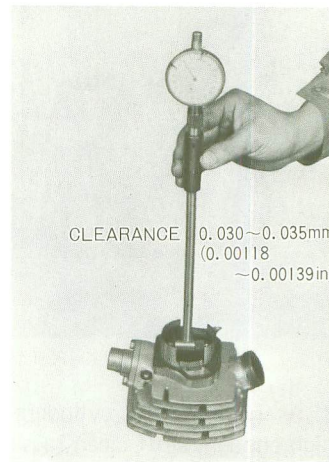

Fig. 4-3-6

### Cylinder Reconditioning

- a. Pistons are available in 0.25 mm and 0.50 mm oversizes.
- b. Cylinders should be rebored and honed to the diameter of the oversize piston, plus the standard clearance.
- c. The error between the maximum and minimum diameter after honing should be no more than 0.01 mm.

### 3. Carbon Removal

Carbon tends to accumulate at the transfer and exhaust ports of the cylinder, thereby impairing both scavenging and exhausting effici-

ency. Be sure to remove carbon accumulations whenever necessary.

Avoid the use of files for carbon removal, because the carbon build-up can not be completely removed as shown in Fig. 4-3-7, or undesirable cuts in these ports may be the result. It is advisable to use a carbon scraper (B) and remove the carbon from every corner of the port. (Fig. 4-3-7)

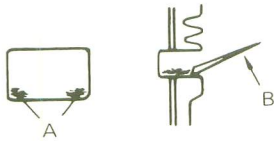

Fig. 4-3-7

#### 4. Installation

- a. Always use new cylinder gaskets when overhauling the engine. (Fig. 4-3-8)

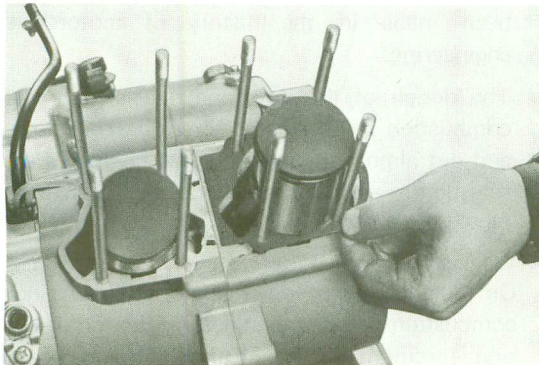

Fig. 4-3-8

- b. When installing the cylinder over the piston, squeeze the piston rings into their grooves (their end gaps should close on the knock pin) so they will not catch and break on the bottom of the cylinder. (Fig. 4-3-9)

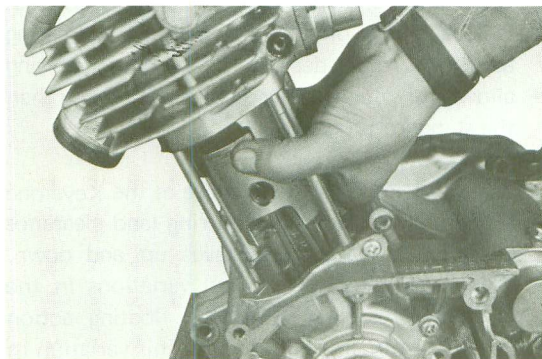

Fig. 4-3-9

#### 5. Miscellaneous

The cylinder intake port is provided with a flange coupling. A larger carburetor can be installed by simply changing the flange coupling in order to modify engine performance. (Fig. 4-3-10)

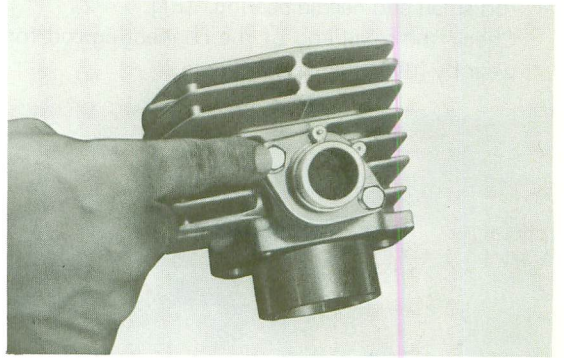

Fig. 4-3-10

### 4-4. Piston Pins

#### 1. Pulling Out the Piston Pin

Remove the clip at one end of the piston pin, using a needle nose pliers (Fig. 4-4-1), and push the pin out from the other side of the piston with a screwdriver.

Before removing the piston pin clip, cover the crankcase opening with a clean rag so you will not accidentally drop the clip in to the crankcase.

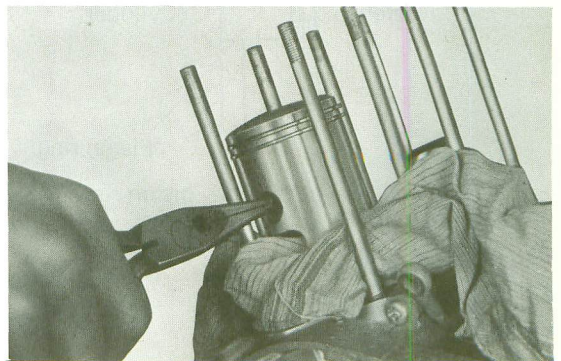

Fig. 4-4-1

## 2. Piston-to-Piston Pin Fit

The piston pin should fit snugly in its bore so that it drags a little as you push it. If the pin is loose, the pin and/or the piston should be replaced. A pin with step wear in its center should be replaced, along with the connecting rod and small end needle bearing. (Fig. 4-4-2)  
Check the small end of the connecting rod for wear by inserting the piston pin.



Fig. 4-4-2

## 4-5. Piston Rings

### 1. Keystone Type Piston and Keystone Ring

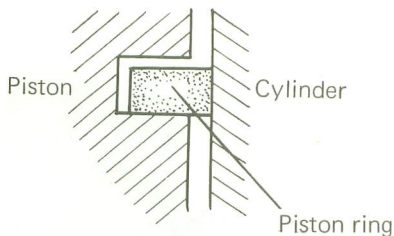

Plain type piston & piston ring

Fig. 4-5-1

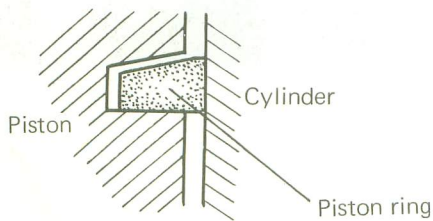

Keystone type piston & piston ring

Fig. 4-5-2

A good seal must be maintained between the piston and cylinder wall for effective use of combustion pressures. It is not practical, however, to attempt to secure a perfect seal. With this in mind, importance is placed on effective sealing and prevention of piston ring sticking.

Piston ring sticking is generally caused by gum deposits which are produced through a breakdown of the fuel and oil from the heat of the combustion process. This gum residue will deposit itself in the ring lands and rings. The subsequent blow-by tends to speed up the accumulation of these gum deposits.

In order to prevent the rings from sticking and to provide more effective sealing of the combustion pressures Yamaha has employed the Keystone piston and ring in its engines. This marks the first time such an application has been made in the history of motorcycle engineering.

The design of the Keystone ring is such that combustion gas pressures force the ring down and out almost simultaneously. This forces the ring tightly against the cylinder wall preventing blow-by. (Fig. 4-5-3)

On the other hand, in the case of the plain ring, combustion pressure first acts on the top of the ring, forcing it down, and then passes between the ring and piston to force the ring against the cylinder wall. This action is considerably slower than that of the Keystone type ring, and will allow more blow-by.

With blow by, heat cannot be dissipated from the piston ring to the cylinder wall and, as was mentioned earlier, excessive combustion heat will cause the oil film to break down creating additional gum deposits. The Keystone ring allows for much better heat transference than the standard type ring.

The most important advantage of the Keystone type ring is that the piston ring land clearance changes as the piston moves up and down. Figs. 5-5-4 and 5-5-5 show variations in the clearance resulting from the floating action of the piston in the cylinder. This variation in ring land clearance produces a "scrubbing" effect that reduces the accumulation of gum

deposits and thus prevents the ring from sticking in the land.

Lastly, the outer surface of the ring is coated with Teflon (Fig. 5-5-6). The Teflon coating serves as an effective aid during ring "seating". In addition, the Teflon coating will follow microscopic irregularities in the cylinder bore more faithfully than previous materials thus providing additional resistance against blow-by.

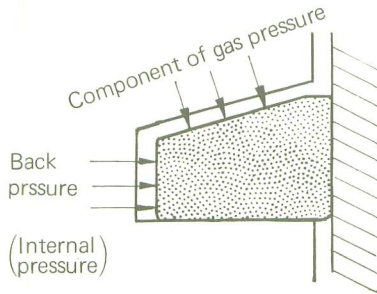
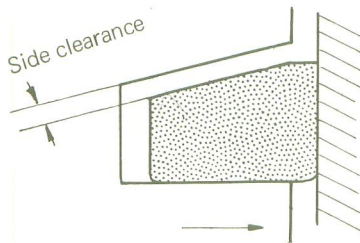
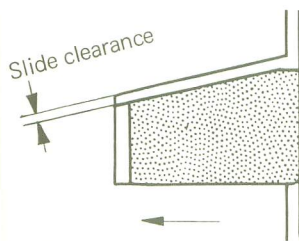

Fig. 4-5-3



Side clearance when piston floats in the direction of the arrow.

Fig. 4-5-4



Side clearance when piston floats in the direction of the arrow.

Fig. 4-5-5

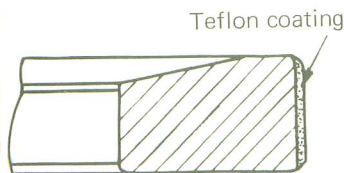

Fig. 4-5-6

## TECHNICAL NOTES ON KEYSTONE RINGS

The keystone ring can be handled in the same manner as conventional rings as far as servicing is concerned. However, the keystone ring is not interchangeable and must be used as a set with a matching Keystone piston.

The Keystone ring can be identified from the conventional by its unique cross-sectional shape. The conventional ring has a rectangular cross-section where as the Keystone ring employs a 7° slope on the top.

### IMPORTANT:

The Keystone type piston has the K mark stamped after the numerals indicating the piston sizes on its head. On the other hand, the Keystone type piston ring has a symbol such as "1 (2) N", or "1 (2) T".

(Numeral 1 denotes the top ring, and numeral 2 the second ring.)

## 2. Removing the Rings

Put your thumbs at each end of the piston ring and pull the piston ring ends apart. Then slide it out of the groove on the back side of the ring lands. (Figs. 4-5-7 and 8)



Fig. 4-5-7

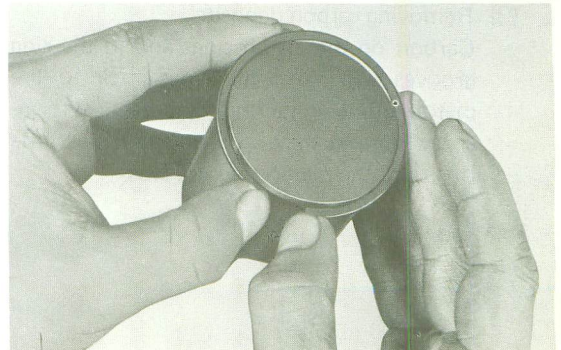

Fig. 4-5-8

### 3. Fitting the Rings

Both rings (top and bottom) are of the same type, and chrome plated. When installing the rings, align their ends with the knock pin. (Fig. 5-5-9)

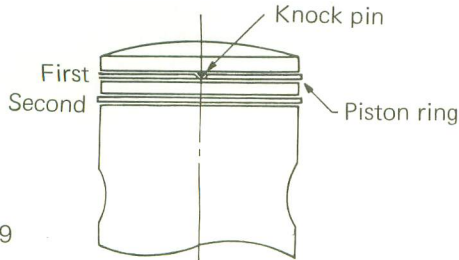

Fig. 4-5-9

### 4. Checking the piston Ring

#### (1) Piston Ring Wear

Improper contact between the piston ring and the cylinder may result in compression *leakage*, or scores or spotty wear on the cylinder wall. Therefore correct surface "contact" between the piston rings and the cylinder should be checked before the piston is installed. Fig. 5-5-10 shows an example of a method for checking the surface contact:

Correctly fit the ring in the cylinder, and then check whether or not any gap is seen between the ring and the cylinder wall by using a sheet of white paper as a reflector. If no gap is found, a good sealing between them is maintained.

#### (2) Measuring the piston ring for wear

Put *the piston ring* into the cylinder so that the ring is parallel with the bottom edge of the cylinder. Then measure the gap between both ends of the ring, using a feeler gauge. (Fig. 4-5-10)

End gap should be between 0.15 mm and 0.35 mm for both No. 1 and No.2 rings.

#### (3) Removing carbon deposits

Carbon on the piston rings and in the ring grooves will make the rings stick to the piston, thus impairing cylinder performance. Remove the piston ring, and clean the rings and the piston ring grooves.

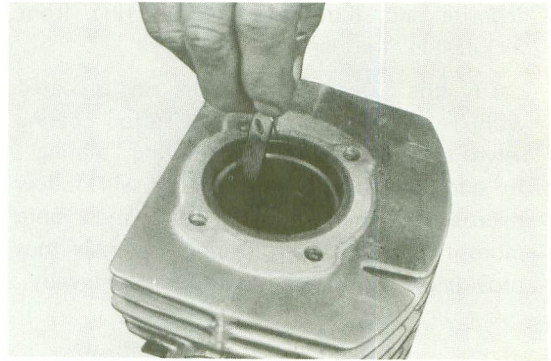

Fig. 4-5-10

## 4-6. Piston

### 1. Checking and Reconditioning the Piston

#### (1) Piston Shapes

The piston has a slightly tapered ring section when it is cold, as shown in Fig. 5-6-1 left. When it warms up, the expansion of the ring section is greater than that of the skirt because the ring section is exposed to higher temperatures.

This decrease the normal clearance between the piston and cylinder wall, as shown in Fig. 4-6-1 right. When the piston is viewed from the bottom, its diameter at A (at the piston pin bosses) is slightly smaller than at B (right angles to the piston pin). At operating temperatures, the piston assumes a round shape, because the expansion at A is greater than B.

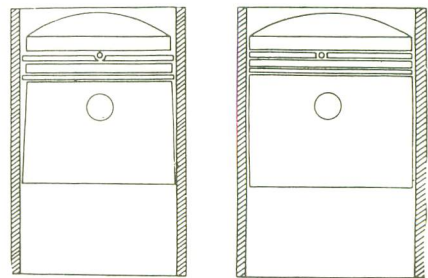

Fig. 4-6-1

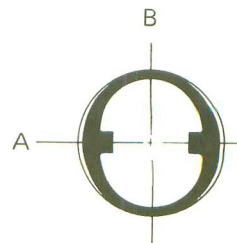

Fig. 4-6-2

## (2) Piston Clearance Measurement

Piston clearance is the difference between the minimum cylinder bore and the maximum piston diameter. Proper clearance is between 0.030 ~ 0.035 mm (0.00114~0.00137 in.) as described in the "Cylinder" section. To determine maximum piston diameter, measure the piston with a micrometer at right angles to the pin bosses 10 mm from the piston bottom edge, as shown in Fig. 4-6-3.

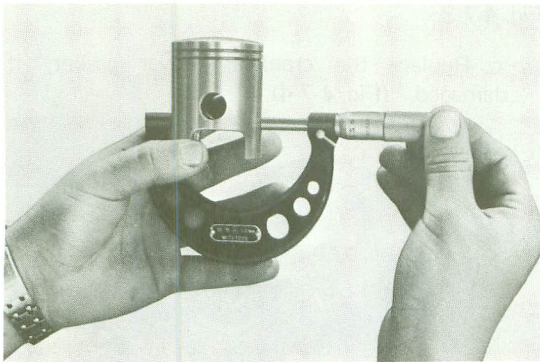

Fig. 4-6-3

## (3) Checking and Reconditioning Pistons

Pistons showing signs of seizure are noisy and keep the engine from developing full power. If a piston that has seized is used again without any correction, another seizure will develop at the same point. Lightly sand these seizure area on the piston areas showing excessive friction with #400 sandpaper.

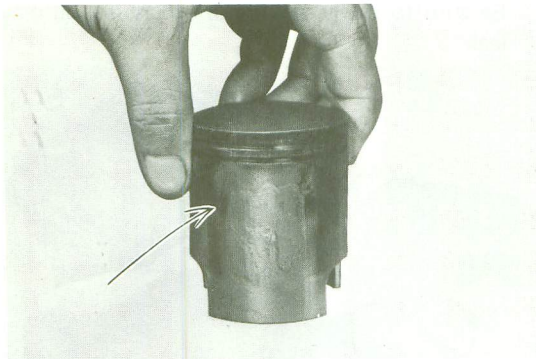

Fig. 4-6-4

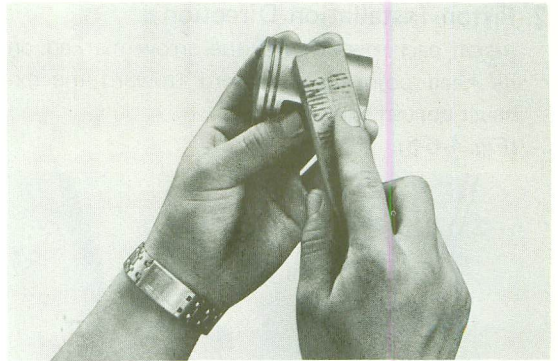

Fig. 4-6-5

## (4) Removing Carbon

Scrape off carbon accumulation on the top of the piston using a screwdriver or a hacksaw blade. (Fig. 4-6-6)

Take note that the piston is not damaged during this process.

Scrape off carbon accumulation in the piston ring grooves in order to prevent the ring from sticking. Do not use an old broken ring. The CS3-B uses Keystone pistons and an old ring will not fit within the ring land. (Fig. 4-6-7)

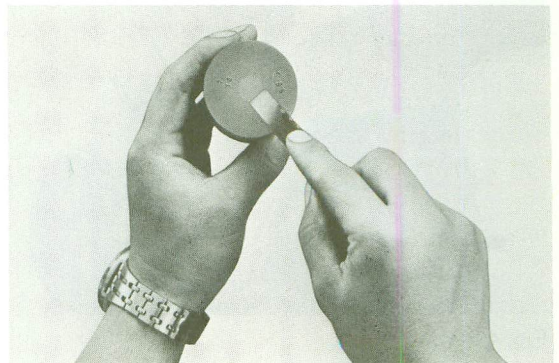

Fig. 4-6-6



Fig. 4-6-7

## 2. Piston Installation Direction

Install each piston with the arrow marked on its head pointing downward (toward the exhaust port of the cylinder).

(Fig. 4-6-8)

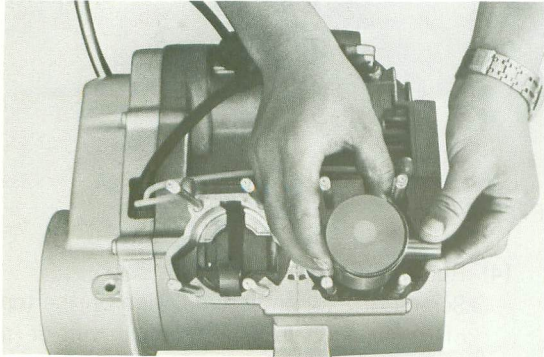

Fig. 4-6-8

## 4-7. Crankcase Cover (R)

### 1. Removal

- a. Remove the kick starter crank clamping and remove the crank. (Fig. 4-7-1)

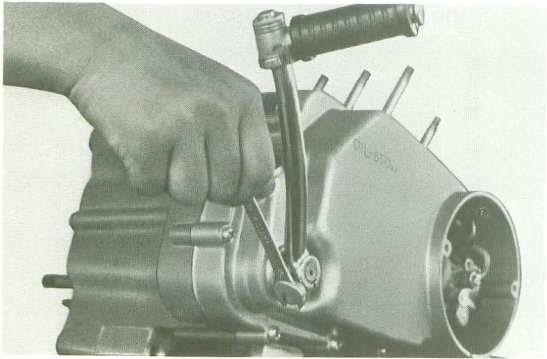

Fig. 4-7-1

- b. Remove the pan-head screws from the crankcase cover (R), and take off the cover. (Fig. 4-7-2 and 3)

(The right crankcase cover may be removed with the oil pump mounted on it after disconnecting the oil delivery lines.)

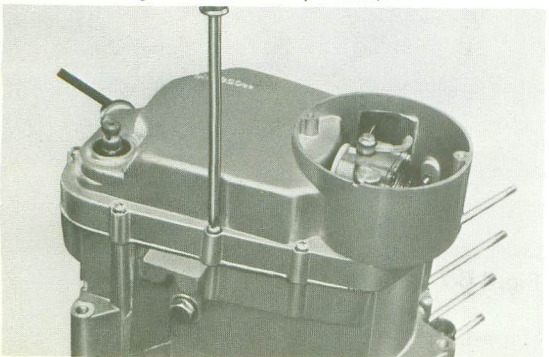

Fig. 4-7-2

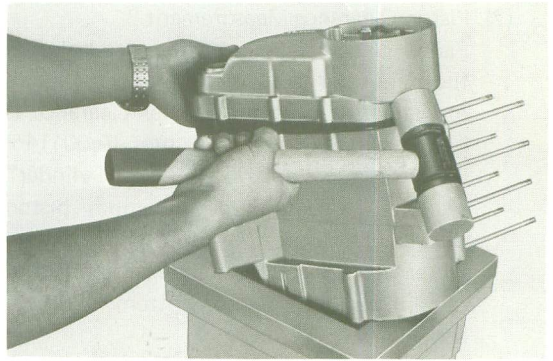

Fig. 4-7-3

- c. Replace the crankcase cover gasket, if damaged. (Fig. 4-7-4)

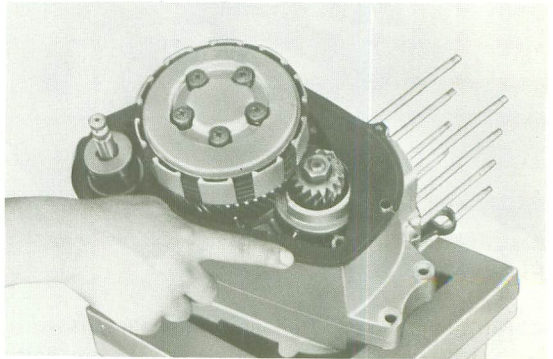

Fig. 4-7-4

### 2. Reinstallation

Coat the right crankcase sealing surface with gasket paste (YAMAHA BOND No. 5), lay the crankcase cover gasket over it, and then replace the right crankcase cover.

(Fig. 4-7-5)

Be sure to apply the bond; otherwise, oil may leak.

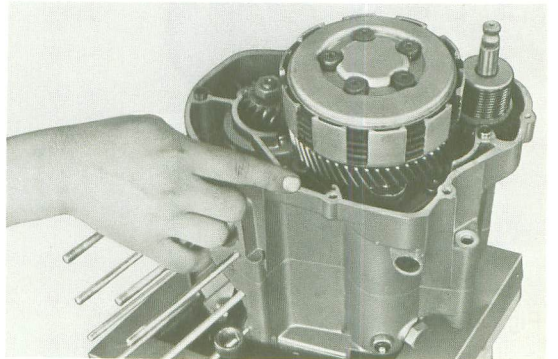

Fig. 4-7-5



## 4-8. Tachometer Drive Gear Assembly

### 1. Tachometer drive gear assembly components.

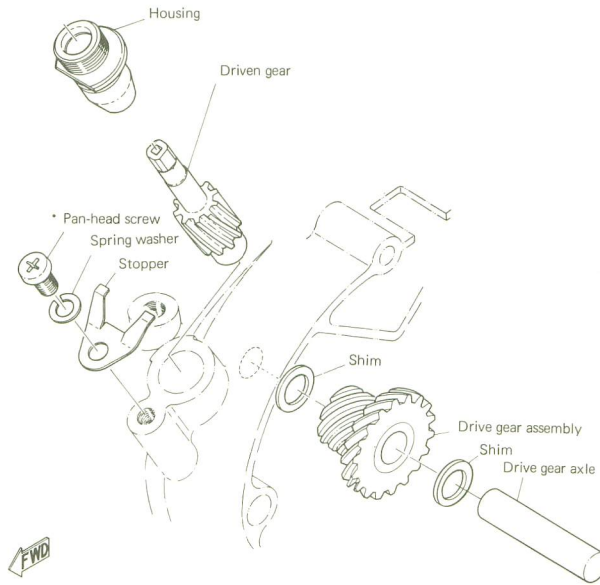

Fig. 4-8-1

## 4-9. Clutch

The purpose of the clutch is to permit the rider to couple or uncouple the engine and transmission. The CS3C clutch is a wet multi-disc type, consisting of five molded cork friction plates and five clutch plates mounted on the main axle of the transmission.

The clutch housing is mounted on the primary driver gear, which in turn is meshed with the primary drive gear that is mounted on the crankshaft.

The primary drive gear has 16 teeth, and the primary driven gear has 53 teeth.

(Primary reduction ratio  $53/16 = 3.313$ )

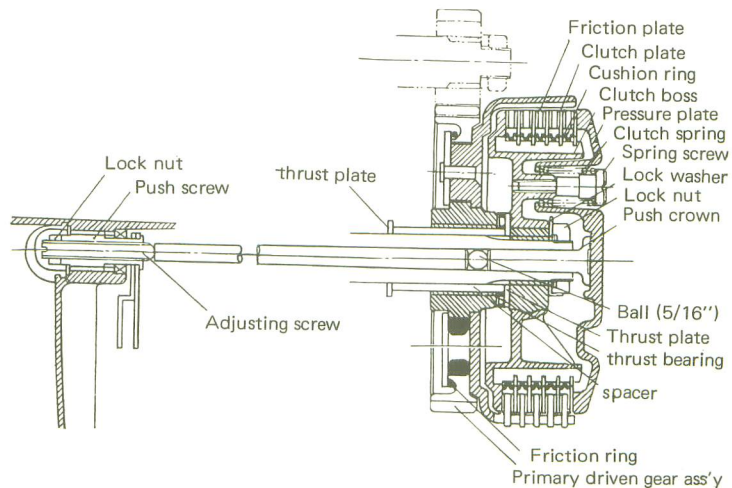

Fig. 4-9-1 Layout of Clutch Assembly

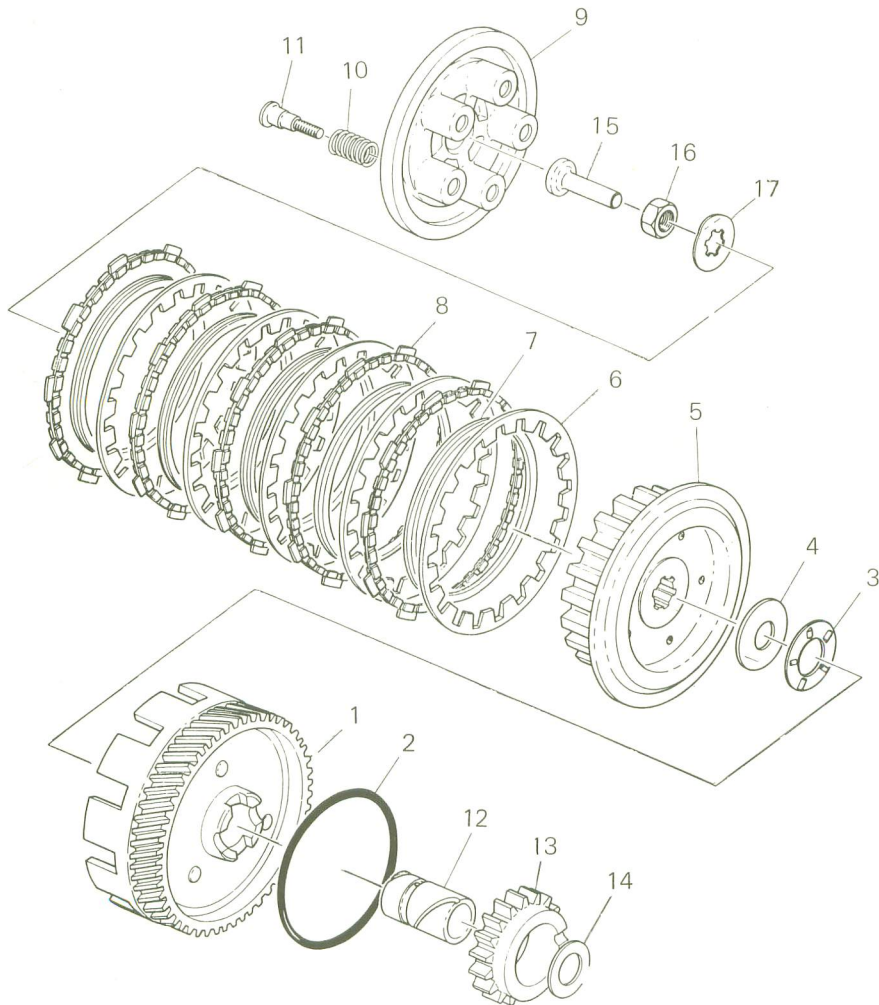

Fig. 4-9-2 Clutch Exploded view

- |                              |                                 |
|------------------------------|---------------------------------|
| 1. Primary driven gear ass'y | 11. Clutch spring holding screw |
| 2. Friction ring             | 12. Spacer                      |
| 3. Thrust bearing            | 13. Kick pinion gear            |
| 4. Thrust plate              | 14. Thrust plate 1              |
| 5. Clutch boss               | 15. Push rod 1                  |
| 6. Clutch plate              | 16. Push rod 1                  |
| 7. Cushion ring              | 16. Lock nut                    |
| 8. Friction plate            | 17. Lock washer                 |
| 9. Pressure plate            |                                 |
| 10. Clutch spring            |                                 |

**Note:**

Figure following part name indicates quantity necessary for one complete assembly.

### 1. Removing the Pressure Plate

Remove the five clutch spring screws, the springs, and the pressure plate.  
(Fig. 4-9-3)

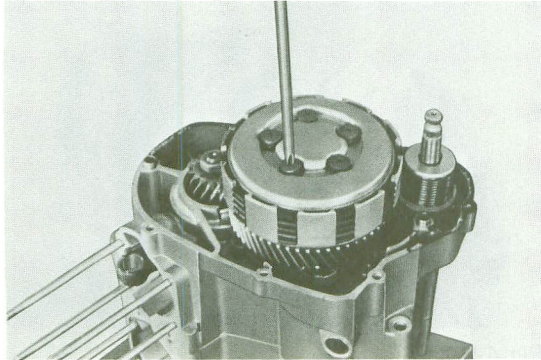

Fig. 4-9-3

### 2. Checking the Clutch Spring

Measure the free length of each clutch spring, and replace any spring more than 1.0 mm shorter than the standard free length. (Figs. 4-9-4 and 5)

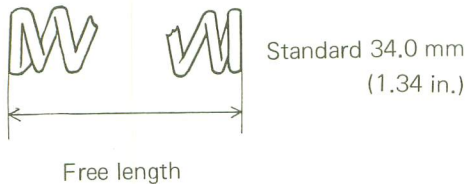

Fig. 4-9-4

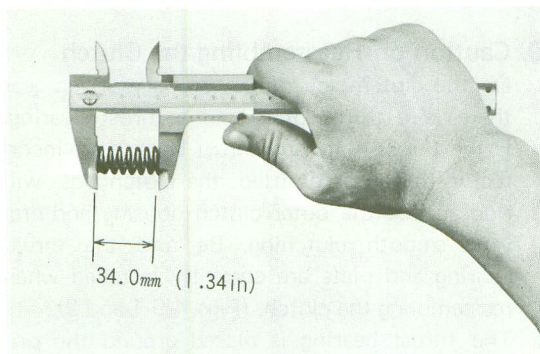

Fig. 4-9-5

### 3. Checking the Friction Plate

Friction plates are designed to wear, so plates worn more than 0.3 mm under the standard thickness (4.0 mm), or showing uneven contact with the clutch plates. Should be replaced. (Figs. 4-9-6 and 7)

Standard 4.0 mm  
(0.157 in.)

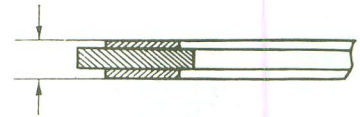

Fig. 4-9-6

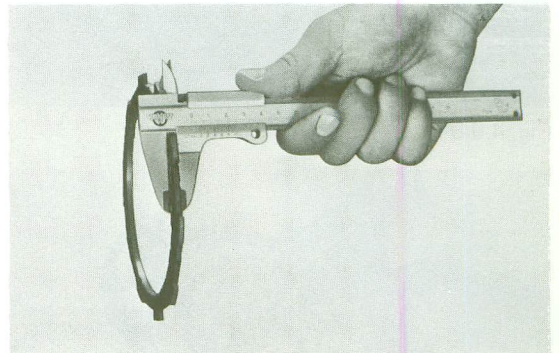

Fig. 4-9-7

### 4. Fitting the Cushion Rings

The cushion rings are installed between each clutch friction plate pair to insure even engagement of the plates. When fitting cushion rings, be sure they are flat and not twisted. (Fig. 4-9-8)

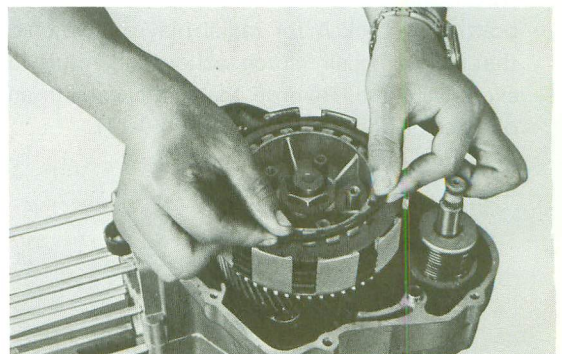

Fig. 4-9-8

### 5. Removing the Clutch Boss

Pull out push-rod 1 and straighten the bent edges of the clutch boss locking washer. Fit the clutch holding tool over the clutch boss, remove the nut, and then the boss itself. (Figs. 4-9-9 and 10)

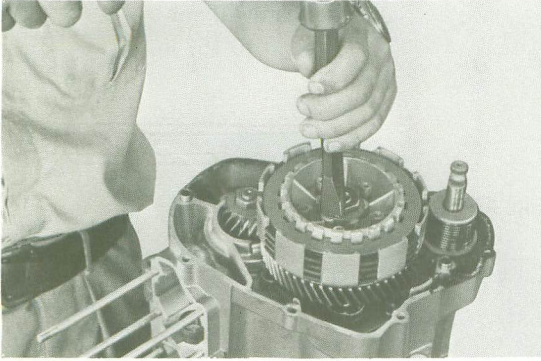

Fig. 4-9-9

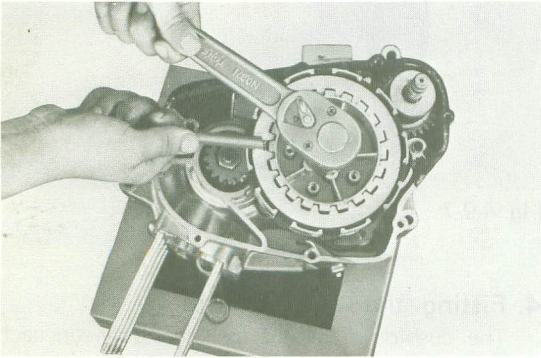

Fig. 4-9-10

### 6. Checking the Primary Driven Gear Ass'y

Insert the spacer in the primary driven gear boss, and check it for radial play or scratches that could impair clutch action and result in excessive noise. Remove the scratches with an oilstone or fine sandpaper. (Fig. 4-9-11)

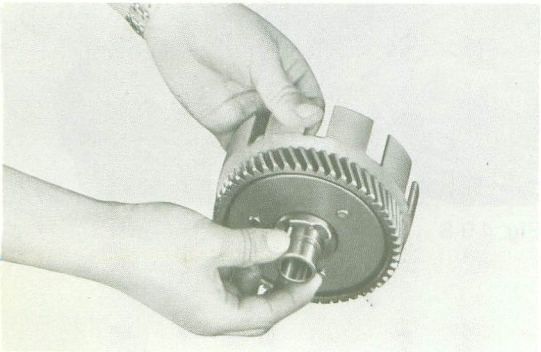

Fig. 4-9-11

### 7. Checking the Spacer

Place the spacer on the main axle, and check it for radial play. If play exist replace the spacer. (Fig. 4-9-12)

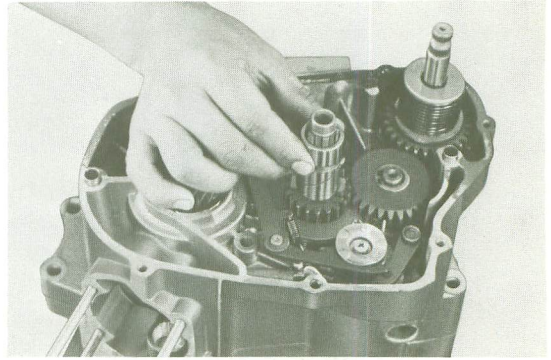

Fig. 4-9-12

### 8. Checking the Push Rod

Remove the push-rod from the clutch boss and roll it over a surface plate. If the shaft is bent, straighten or replace it. (Fig. 4-9-13)

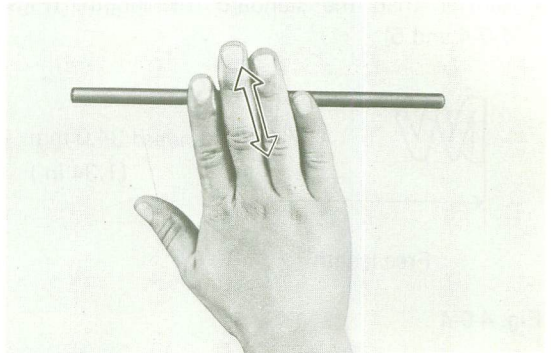

Fig. 4-9-13

### 9. Caution on Reassembling the Clutch

On the clutch side of the primary driven gear there is a thrust plate and a thrust bearing. If the thrust plate and thrust bearing are incorrectly fitted, or omitted, the clutch boss will ride against the outer clutch housing and prevent smooth clutching. Be sure the thrust bearing and plate are correctly installed when reassembling the clutch. (Figs. 4-9-1 and 2).

The thrust bearing is placed around the primary gear spacer. When installing the clutch boss, exercise care not to slip the thrust bearing from the spacer.

Grease the surface of the thrust bearing that goes against the outer housing hold the bearing in place.

## 10. Clutch Adjustment

The friction plate and clutch plate, which are component parts of the clutch, are liable to wear after years of use. The wear of these parts results in poor clutch action or clutch slippage. Replace or correct them if worn.

### (1) Adjusting the Adjusting Screw.

(Fig. 4-9-14)

- a. Remove the dynamo cover located on the left side of the crankcase cover.
- b. Loosen the adjusting screw lock nut as shown in Fig. 4-9-14.
- c. Slowly tighten the adjusting screw until resistance is felt. This means that the play of the push rod is removed. Then, back it off a 1/4 turn. Tighten the lock nut.

### (2) Adjusting the Clutch Cable

A. This adjustment is made on the left upper part of the crankcase cover.

(Refer to Fig. 4-9-14).

- a. Loosen the clutch cable adjusting screw lock nut.
- b. To reduce the play of the cable, loosen the adjusting screw, and to increase the play, tighten the screw. Adjust clutch lever free play to 2 ~ 3 mm. (Fig. 4-9-15)
- c. Fully tighten the lock nut.

B. Adjustment on the upper part of the clutch cable. (Refer to Fig. 4-9-15)

- a. Loosen the lock nut.
- b. To decrease the play of the clutch cable, turn the cable adjusting screw clockwise, while to increase the play, turn the screw counterclockwise. If the play is between 2 to 3 mm, the cable is adjusted properly.

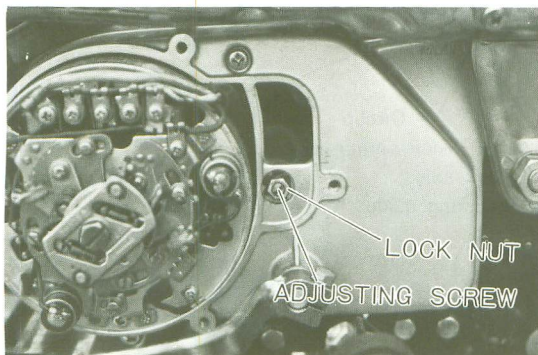

Fig. 4-9-14

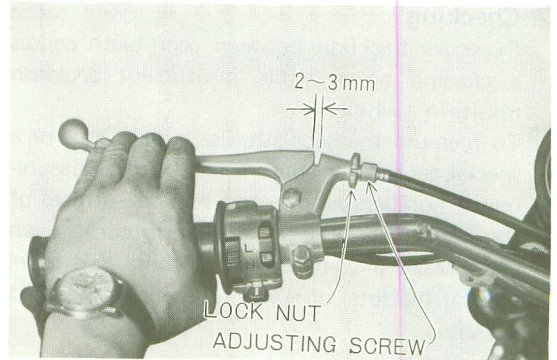

Fig. 4-9-15

## 4-10. Primary Drive Gear

### 1. Removal

- a. Feed a rolled-up rag between the teeth of the primary drive gear and the primary driven gear to lock them.

(Fig. 4-10-1)

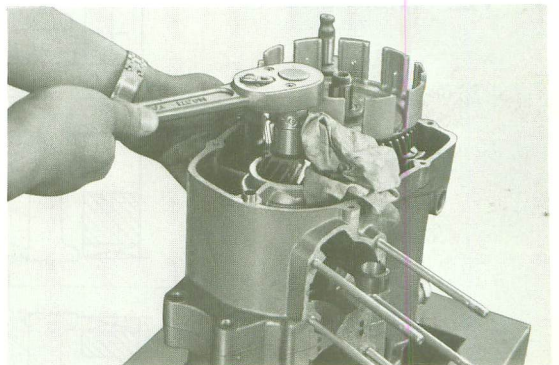

Fig. 4-10-1

- b. To remove the gear, use two slot-head screw-drivers in the manner as shown in Fig. 4-10-2.

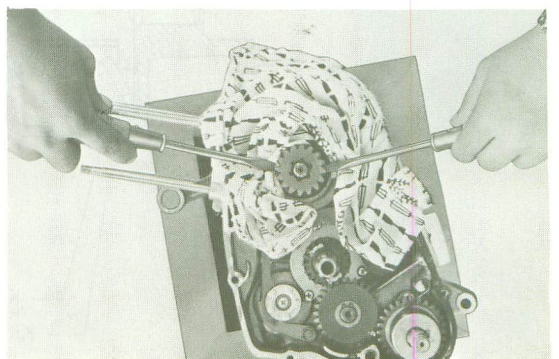

Fig. 4-10-2

## 2. Checking

Excessive backlash between gear teeth causes a clashing noise, while insufficient backlash results in a whine.

To measure the backlash, use a dial gauge or a special gauge. For convenience of this measurement, numbers are marked on the surfaces of the *primary* drive gear and the primary driven gear. Make a combination of these two gears so that the total of numbers reaches a specified set value.

Standard Value

TOTAL OF NUMBERS  $128 \pm 1$  mm.

Check the gears for scratches, wear and shaft-to-hole fit, and replace worn parts. If the replacement of worn parts does not cure the clashing noise or whine adjust gear backlash by means of increasing or decreasing the standard value (total of numbers).

## 4-11. Distance Collar

Remove the distance collar from the crankshaft, using your fingers or pliers. When reinstalling the distance collar first put an adequate amount of grease in the lip cavity of the crankshaft oil seal. Be sure to install the collar with its chamfered end inward.

## 4-12. Kick Starter

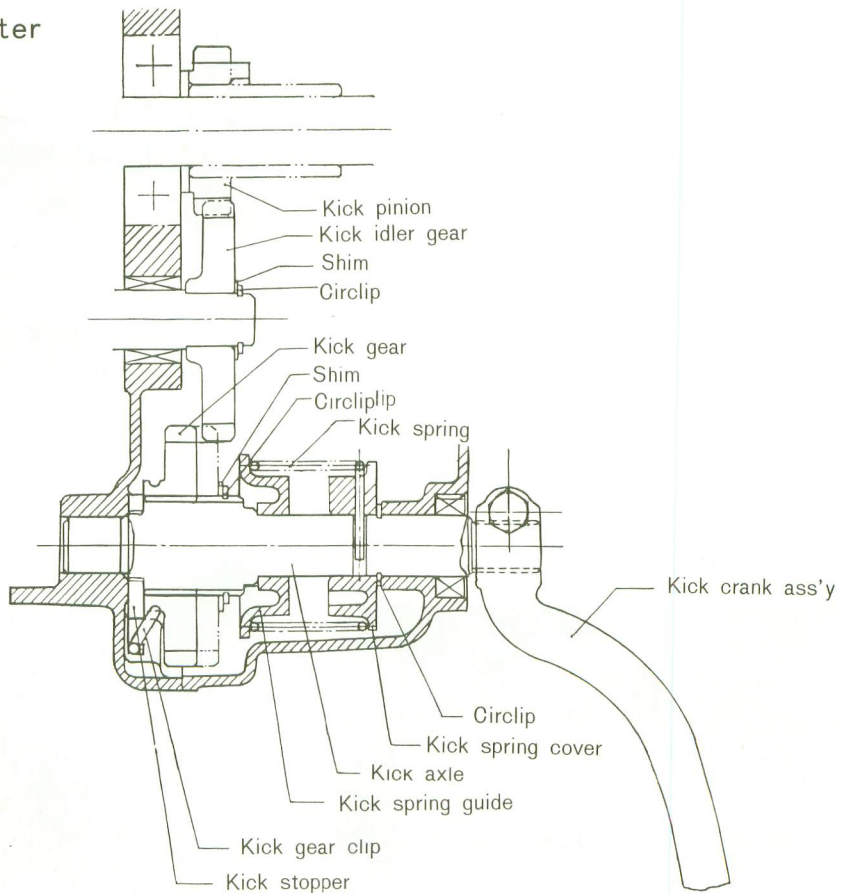

Fig. 4-12-1 Kick Cross Section

## Mechanism

The primary kick-starter system (one-touch kick-starter) is employed. However, a new "non-constant-mesh" mechanism has been introduced into the CS3-B kick-starter, instead of the constant-mesh kick gear type, such as the ratchet and roller-lock systems.

That is, the kick gear meshes with the idler gear only when the kick-starter pedal is kicked. After the engine is started, the kick gear is disengaged from the idler gear. This mechanism not only eliminates noise resulting from the constant mesh of the kick gear with the idler gear, but also greatly contributes to the durability of the kick starter assembly.

As the kick starter axle is turned, the kick gear splined to the kick axle, having spiral splines on its surface, is slid upward along the axle. (In this case, the kick gear moves only axially without rotating because of the kick gear clip fitted in the kick gear.) When the kick gear moves upward, teeth of the kick gear may clash against teeth of the idler gear. (Although there will be possibility of smooth meshing without clashing.)

The kick gear clip is designed to absorb the impact of clashing, and at the same time cause the kick gear to rotate so that the kick gear will smoothly come into mesh with the idler gear.

(Refer to Figs. 4-12-2 and 3) After the kick gear has meshed with the idler gear, the kick gear is further slid upward without rotating. At the instant that the back of the kick gear contacts the circlip, the thrust load is imposed on the kick gear, thereby giving it turning force and rotating the crankshaft to start the engine.

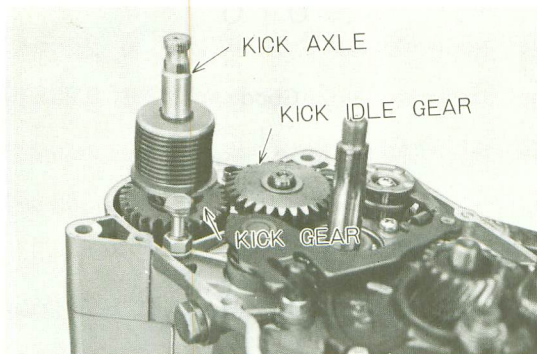

Fig. 4-12-2

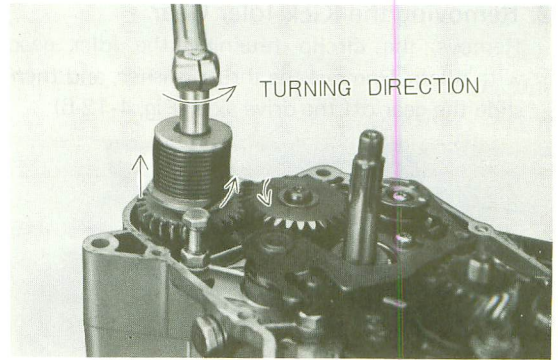

Fig. 4-12-3

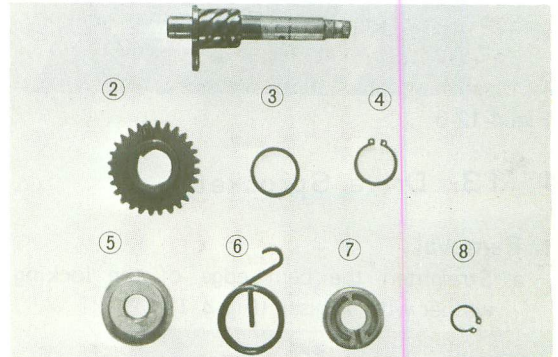

Fig. 4-12-4 Exploded View of the Kickstarter

1. Kick-starters shaft
2. Kick gear
3. Adjusting shim
4. Circlip
5. Kick return spring guide
6. Kick return spring
7. Kick return spring cover
8. Circlip

### 1. Removal

The kick starter system can be removed as an assembly. (Fig. 4-12-5)

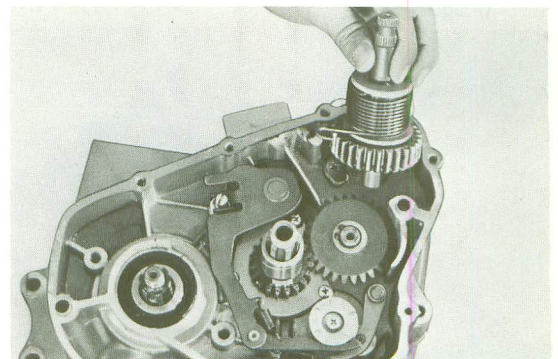

Fig. 4-12-5

## 2. Removing the Kick Idler Gear

Remove the circlip retaining the idler gear with pliers. Remove the thrust washer, and then slide the gear off the drive axle (Fig. 4-12-6)

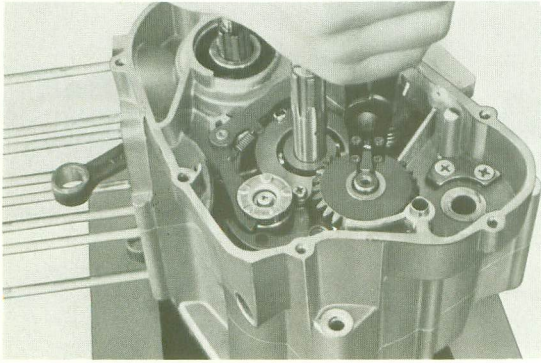

Fig. 4-12-6

## 4-13. Drive Sprocket

### 1. Removal

- a. Straighten the bent edge of the locking washer with a chisel. (Fig. 4-13-1)

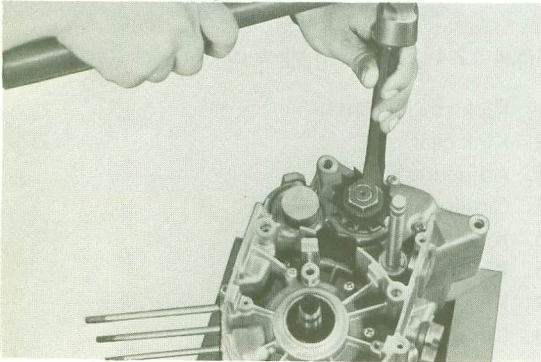

Fig. 4-13-1

- b. Keep the drive sprocket from turning with the flywheel magneto holding tool, then loosen the sprocket nut. (Fig. 4-13-2)

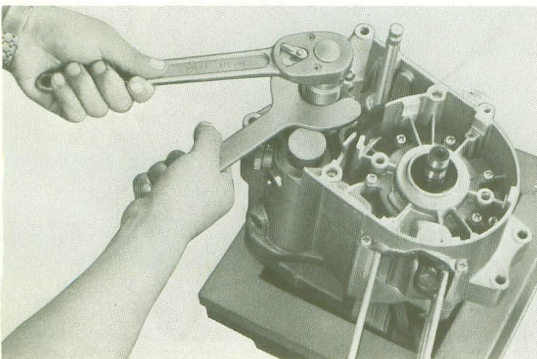

Fig. 4-13-2

- c. If no flywheel magneto holding tool is available, shift the transmission to 1st gear, fit a socket wrench on the sprocket nut, and hit the handle of the wrench with a hammer so that impact will loosen the nut.

## 2. Checking the Drive Sprocket

A worn drive sprocket may result in abnormal noise, and shorten the life of the chain. Check the teeth of the sprocket teeth for wear and deformation.

Checking the Chain and Drive Sprocket for Meshing:

Drive sprocket wear can be checked by inspection the teeth, but it can more easily be checked by observing the meshing of the sprocket with the chain.

Whether the drive sprocket is worn or not can be determined by using a new drive chain. If there is excessive play between the sprocket and the new chain, replace it. (Figs. 4-13-4)

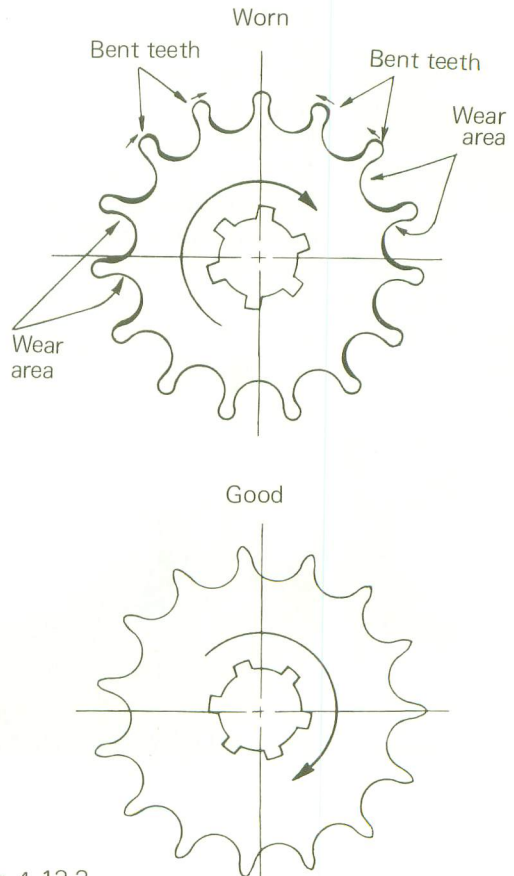

Fig. 4-13-3



Clean the chain with solvent before checking it. Then hold the chain in your fingers, as shown in Fig. 4-13-5 and check whether the chain bends without kinking.

Next, suspend the chain as shown Fig. 5-13-7. If the chain exhibits curvatures, (A, B and C) as shown in Fig. 4-13-7, it is defective. Replace it.

Curvatures may often result from lack of lubrication, dirt, or rust. In this case, reclean the chain and repeatedly bend it back and forth in detergent oil, then check it again for defects.

Another good test for wear is to mesh the chain with a new sprocket and check for excessive slack. The chain is bad if you can pull it away from the curvature of the sprocket a distance of more than a  $\frac{1}{2}$  link.

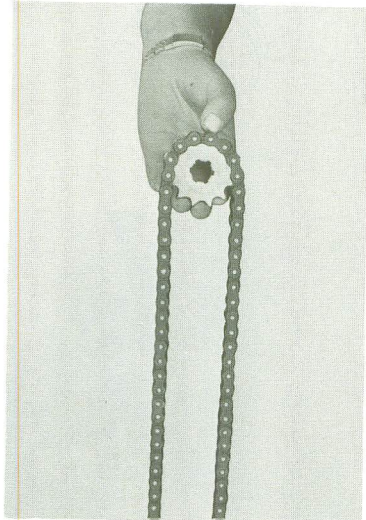

Fig. 4-13-4

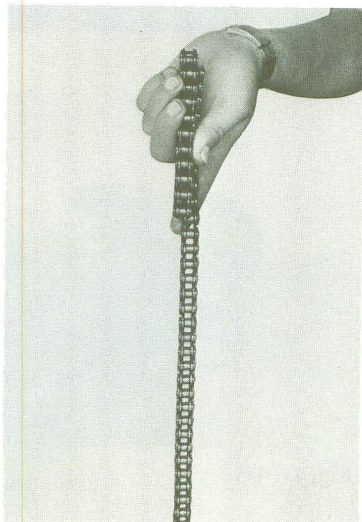

Fig. 4-13-5

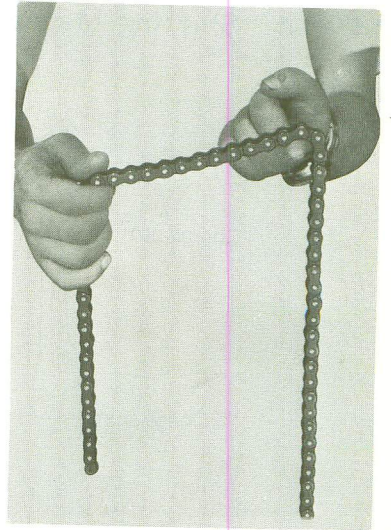

Fig. 4-13-6

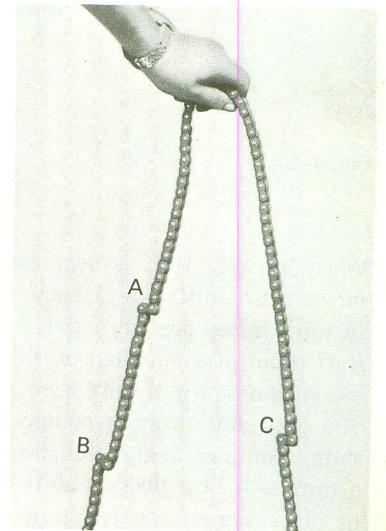

Fig. 4-13-7

4-14. Shifting Mechanism

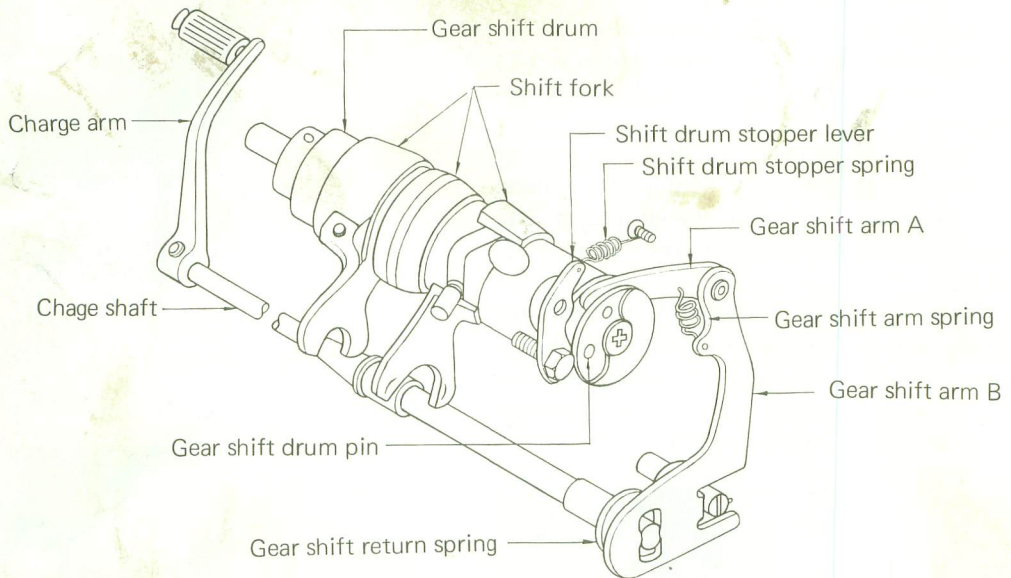

Fig. 4-14-1

When the gear shift is depressed, the gear shift moves gear shift arm B back and forth, which in turn causes, gear shift arm A to push the gear shift drum pins mounted on the gear shift drum, thus turning the gear shift drum. The gear shift drum is equipped with five gear shift drum pins, and is designed to make 1/5 of a turn each time the gear shift lever is depressed. In other words, one full turn of the drum will shift the transmission through five stages; first, second, third, fourth and fifth. The gear shift pins are held by the disc so that the stopper plate may secure each position of the five stages. The outer surface of the gear shift drum is provided with slots, along which the shift forks travel back and forth when shifting gears. The neutral position is located between the first and second gear shift drum pins, and the stopper mechanism is located on the left side of the shift drum.

1. Removing the Gear Shift Shaft Ass'y

To remove gear shift arm A, remove the circlip and washer. (Fig. 4-14-2) Lift up gear shift arm from the shifter drum, and remove it from the right side of the engine. (Fig. 4-14-3)

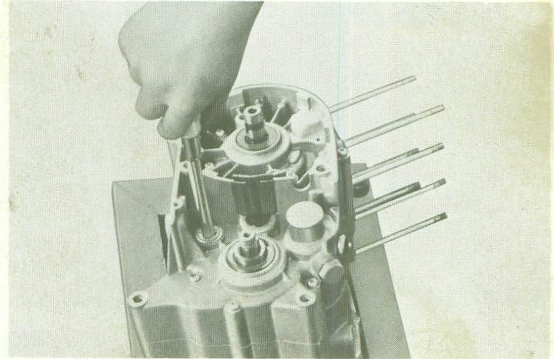

Fig. 4-14-2

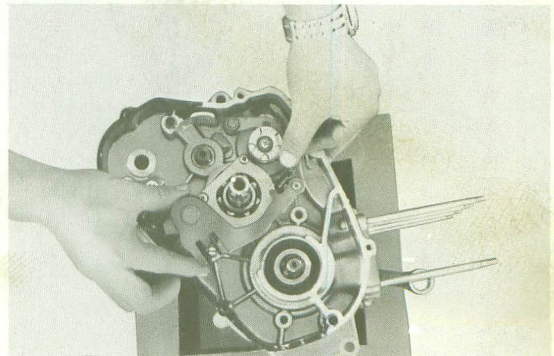

Fig. 4-14-3

## 2. Checking Gear Shift parts

- a. Check the gear shift return spring for fatigue or damage. A broken or fatigued gear shift return spring will impair the returning action of the shifting action of the shifting system.
- b. A broken or fatigued gear shift arm spring will result in shifting failures.

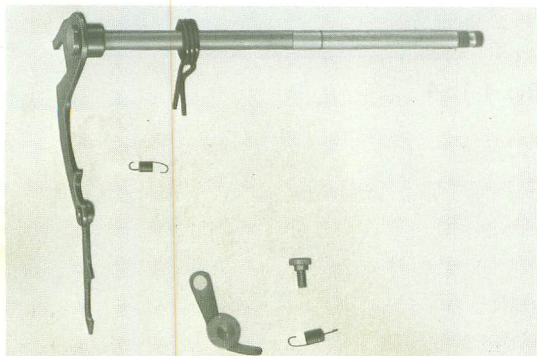

Fig. 4-14-4

## 3. Gear Shift Arm

- a. Removal  
First remove the mounting bolt and remove the spring one by one.
- b. Checking the gear Shift Arm Spring (Refer to Fig. 4-14-5).  
A fatigued or broken gear shift arm spring may let the shift arm slip from one shifter drum pin to another. Check the spring for proper tension and replace it if weak or broken.

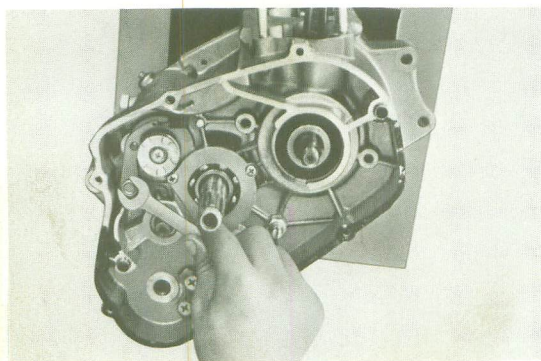

Fig. 4-14-5

## 4. Reconditioning

If the shifting assembly does not work correctly (e.g., slippage or shifting half-way), adjust the gear shift return spring stop screw (eccentric-shaped screw) to correct the shift arm action. (Fig. 4-14-6)

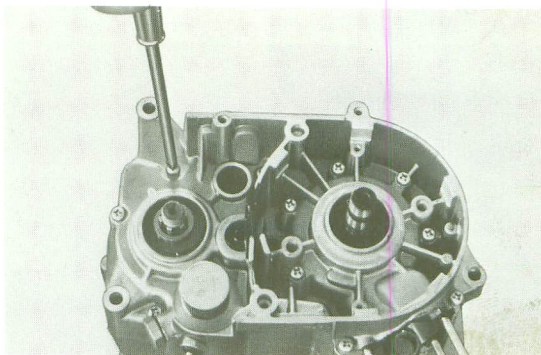

Fig. 5-14-6

## 4-15. Splitting the Crankcase

### 1. Splitting

The crankcase may be split from either the left or right side. However, to facilitate the subsequent servicing operations, the splitting tool should be installed on the right half of the crankcase.

- a. Remove the pan head screws on the left side crankcase. (Fig. 4-15-1)

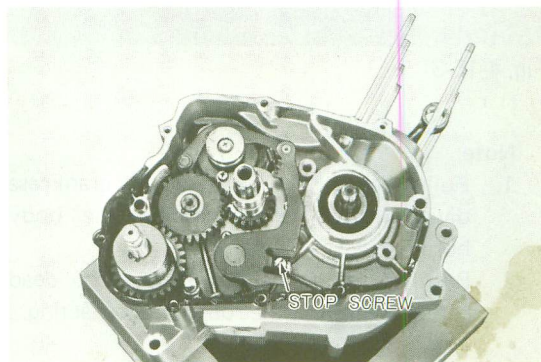

Fig. 4-15-1

## ENGINE - Splitting the Crankcase

- b. Install the crankcase dividing tool on the right crankcase and alternately tap the transmission main axle and the side of the right half with a soft faced hammer, so that the right half eventually separates completely from the left half. (Figs. 4-15-2 and 3)

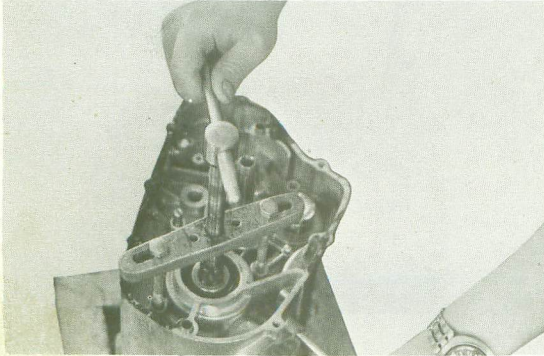

Fig. 4-15-2

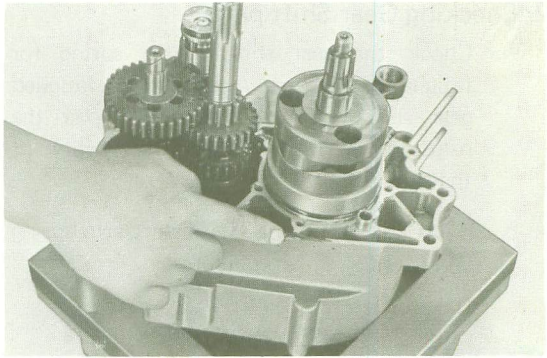

Fig. 4-15-4

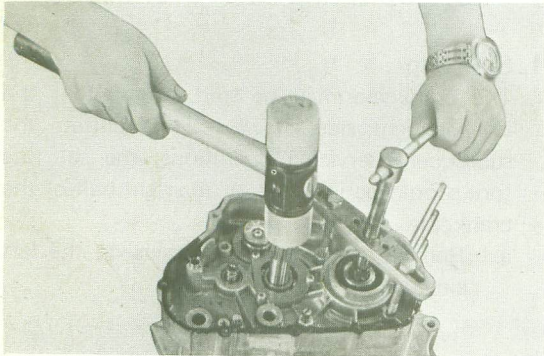

Fig. 4-15-3

### Note:

1. Fully tighten the bolts of the crankcase dividing tool, while keeping the body horizontal.
2. Position the connecting rod at top dead center to prevent the rod from contacting.

## 2. Reassembling

When reassembling the crankcase, be sure to clean the mating surfaces thoroughly and then apply YAMAHA BOND No. 5 to the mating surfaces of the crankcase.

(Fig. 4-15-4)

4-16. Transmission

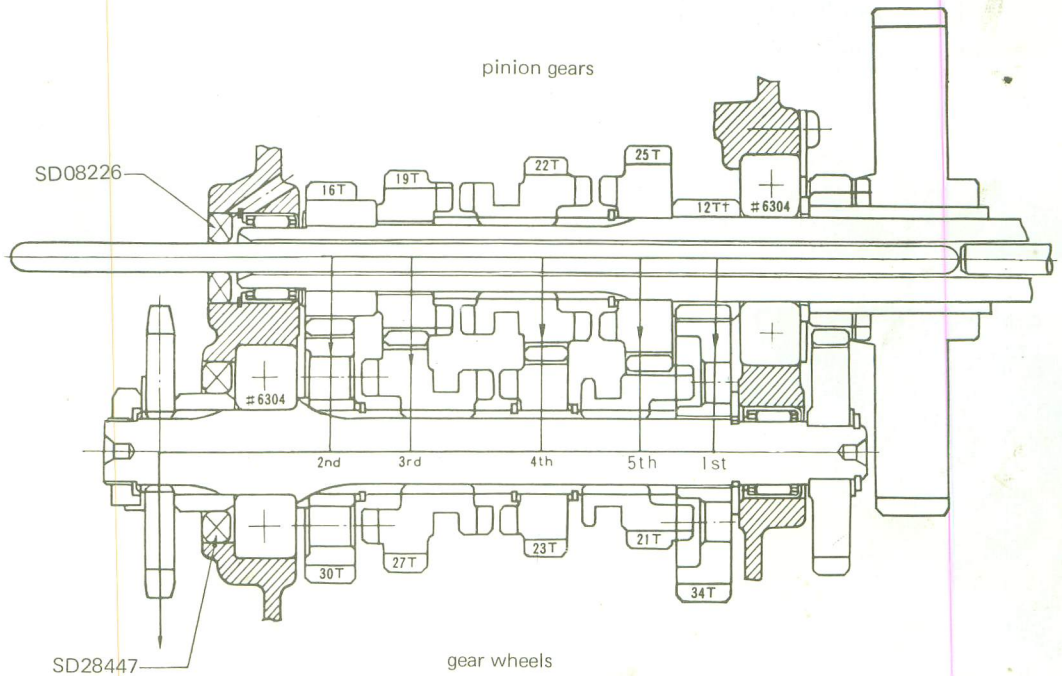

Fig. 4-16-1 Layout of Transmission Gears

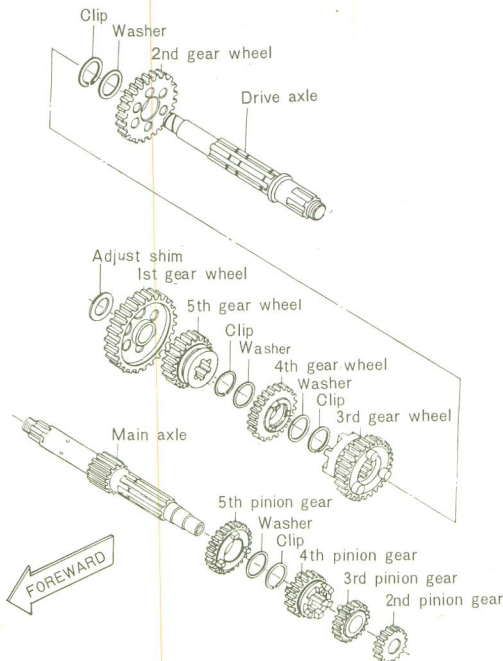

Fig. 4-16-2 Exploded View of Transmission

For details of assembly, arrangement and parts of the transmission, refer to Figs. 4-16-1 and 2. The primary reduction ratio is 53/16 (3.313), and the secondary reduction ratio is 40/14 (2.860). Therefore, the total reduction ratios will be:

	Primary reduction	Transmission gear reduction	Secondary reduction	Total reduction ratio
Low	3.313 (53/16)	2.833 (34/12)	2.860 (40/14)	26.843
2nd	"	1.875 (30/16)	"	17.766
3rd	"	1.421 (27/19)	"	13.464
4th	"	1.045 (23/22)	"	9.902
5th	"	0.840 (21/25)	"	7.959

1. Removal

- (1) Remove the circlip, holder, and washer from the gear shift drum on the left side of the engine. (Figs. 4-16-3 and 4)

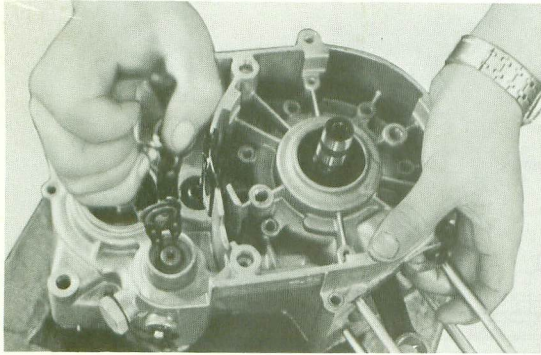

Fig. 4-16-3

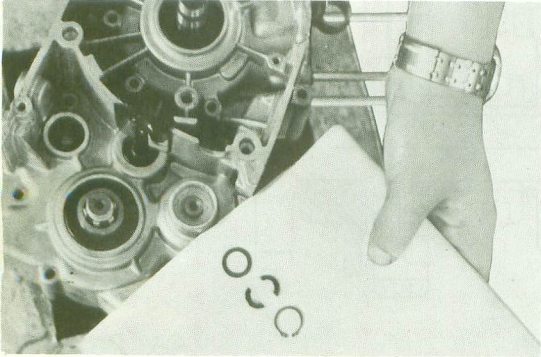

Fig. 4-16-4

(2) Remove the neutral stopper mechanism.  
(Figs. 4-16-5, 6)

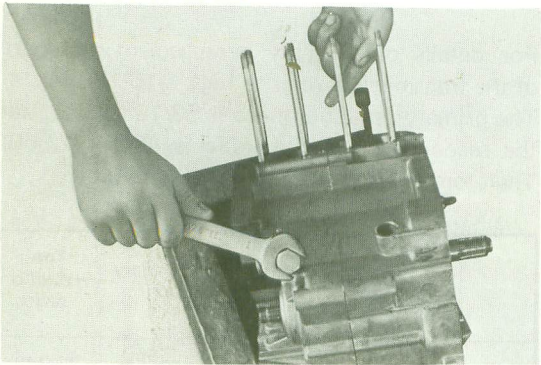

Fig. 4-16-5

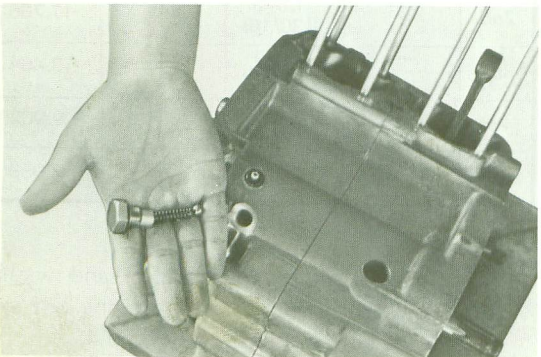

Fig. 4-16-6

(3) Remove the transmission and shifter as a unit. (Fig. 4-16-8)

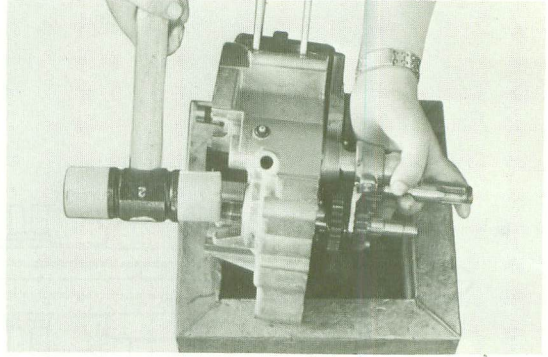

Fig. 4-16-8

## 2. Caution on Reinstallation

- a. Reinstalling the Gear Ass'y and Shifter  
Reinstall the transmission and shifter as a unit in the left crankcase half after they are sub assembled. Remember that the gear ass'y and shifter drum can not be installed separately. (Fig. 4-16-9)
- b. Caution on Reassembling the Crankcase  
The following measures should be taken to prevent the shift forks from bending.

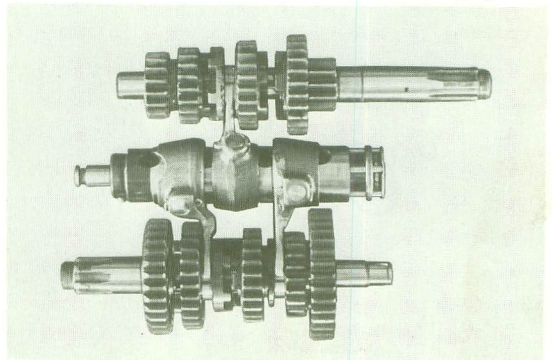

Fig. 4-16-9

- Never reassemble the crankcase halves, with the transmission in first gear. Otherwise, the fifth pinion dog may batter against wedge the pinion teeth, and cause the shift fork to bend.

## 4-17. Crankshaft

Of all the engine parts, the crankshaft requires the highest degree of accuracy in engineering.

The crankshaft oil seal in the YAMAHA 200 CS3C is a solid aluminum, laby rinth type, which is superior to the conventional type in resistance to heat, oil and wear.

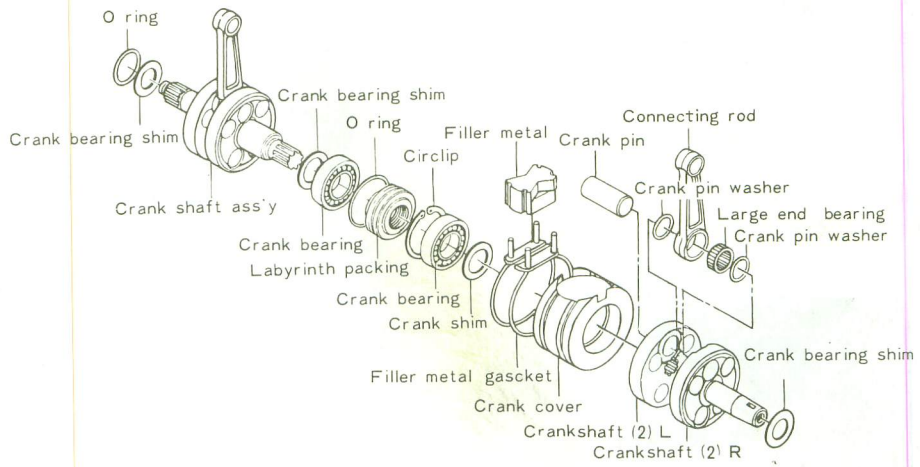

Fig. 4-17-1 Crankshaft Ass'y Component Parts

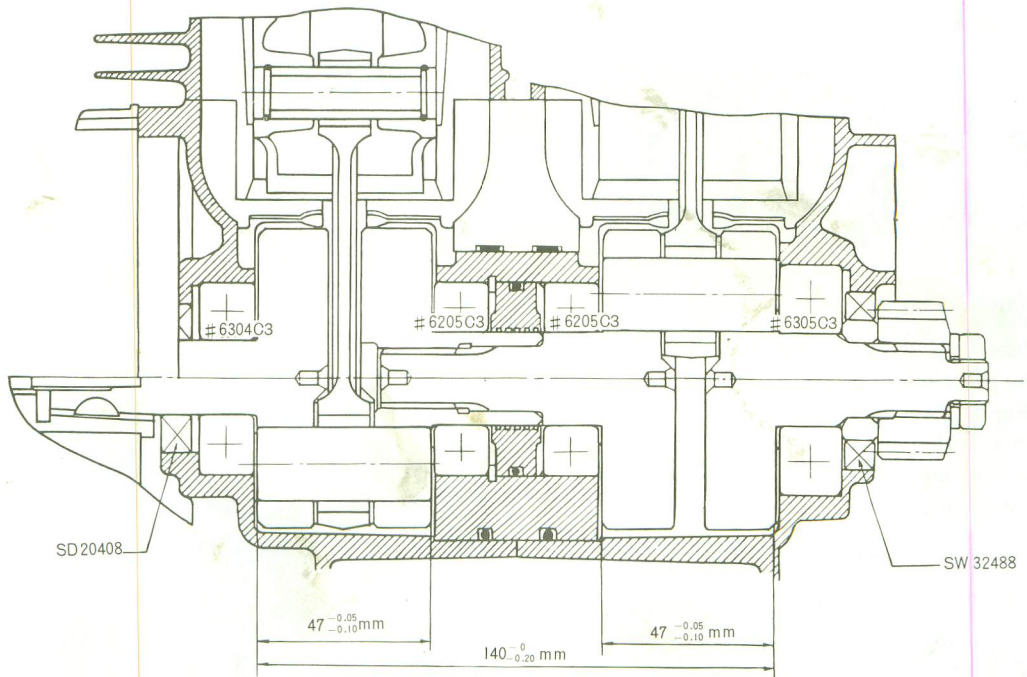

Fig. 4-17-2 Assembled Crankshaft Dimentions

### 1. Removing the Crankshaft Ass'y

- a. Remove the crankshaft ass'y with the crankcase dividing tool. (Fig. 4-17-3)
  - Tighten the dividing tool bolts into the crankcase, and keep the crankcase horizontal.
  - Pull the connecting rod up to top dead center so it will not hit the crankcase, and keep it there by inserting a thrust bearing between the end of the crankshaft and the center bolt of the dividing tool.

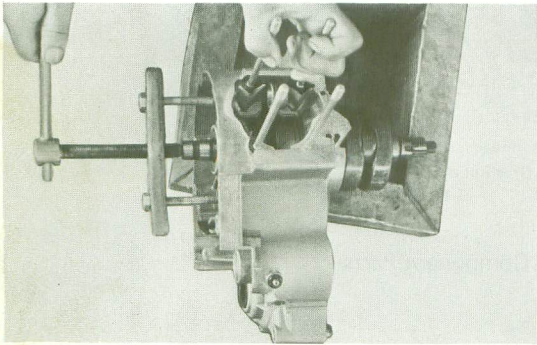
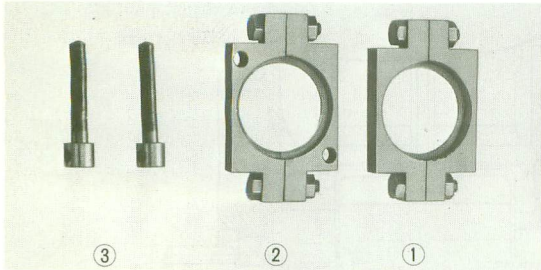

Fig. 4-17-3

### 2. Disassembling the Crankshaft Ass'y

To disassemble the crankshaft ass'y use a set of special tools as shown in Fig. 4-17-4, and follow the steps 1) ~ 8).



- (1) Insert the tool (1) into the gap between the crank wheel and the crank cover. (Fig. 4-17-5)
- Then install the tool (2) in the same manner as above on the other half of the crankshaft.

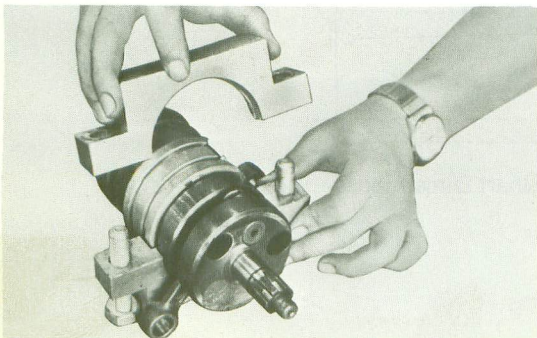

Fig. 4-17-5

- (2) Fully tighten the bolts of tool (1) and (2). Failure to tighten the bolts completely can result in tool failure. (Fig. 4-17-6)

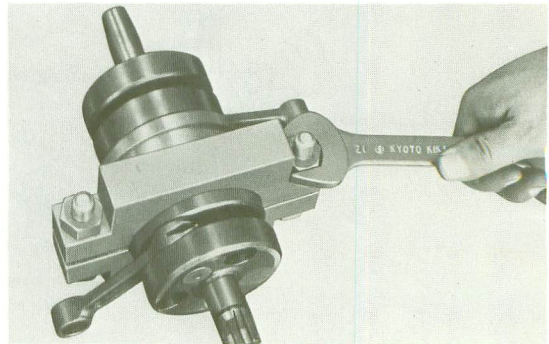

Fig. 4-17-6

- (3) Fig. 4-17-7 shows the tools installed on the crankshaft ass'y.

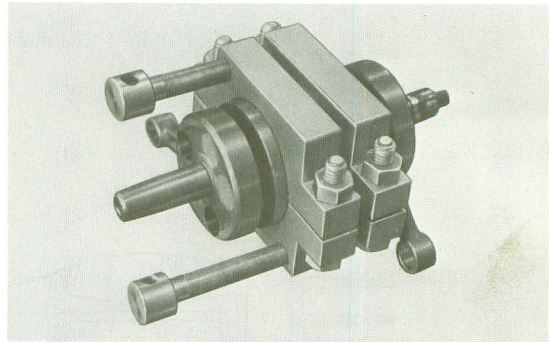

Fig. 4-17-7

- (4) Hold the crankshaft ass'y in a vice, and disassemble the ass'y into two parts by alternately giving one turn to each bolt (3) which is installed on the tool (2), so that the crankshaft ass'y splits into two parts. (Fig. 4-17-8)

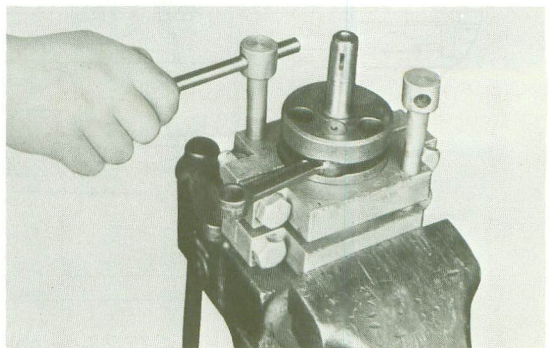

Fig. 4-17-8



- (5) Fig. 4-17-9 shows the disassembled crankshaft ass'y. To remove the crank cover and bearing, use a press. Note that the ignition side was removed. This allows free made center spline to protrude and provide an easier working surface for the press.

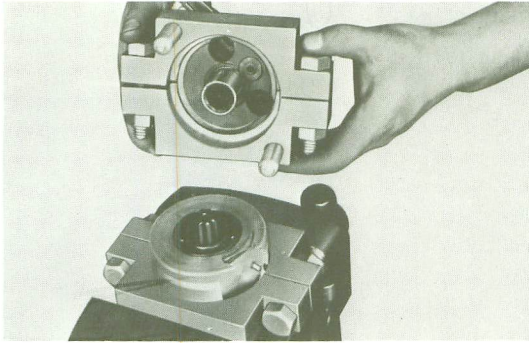

Fig. 4-17-9

- (6) Remove the crankshaft pin in the manner as shown in Fig. 4-17-10. (For this purpose, use the jigs as shown in Fig. 4-17-11)
- (7) Next, take the remaining crank wheel with the crank pin still in it, turn the wheel over, place it on the support plates, and press out the crank pin.
- (8) Repeat steps "(6)" and "(7)" to disassemble the other crank half.

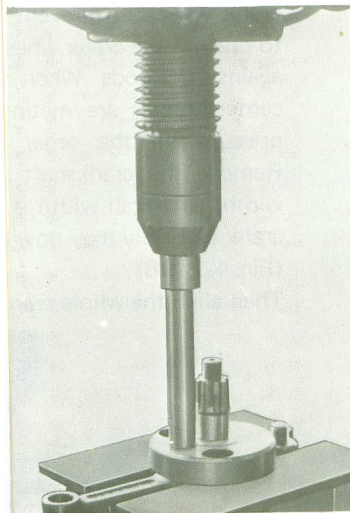

Fig. 4-17-10

### 3. Reassembling the Crankshaft Ass'y

To reassemble the crankshaft ass'y use a set of special jigs as shown in Fig. 4-17-11.

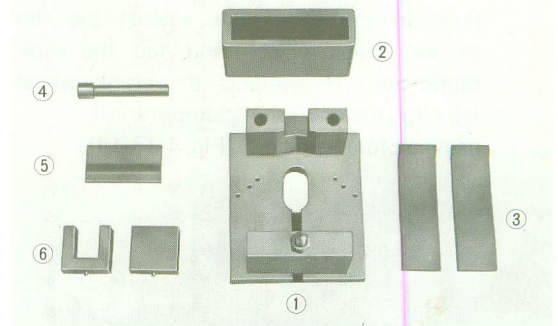

Fig. 4-17-11

- (1) Install Tool No. 6 (used to space the crankshaft ass'y) on Tool No. 1. (Fig. 4-17-12)

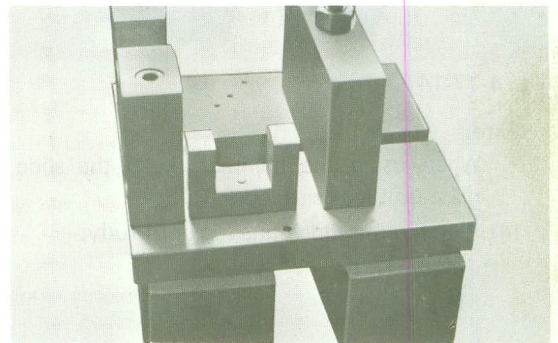

Fig. 4-17-12

- (2) Press the crank pin into one crank wheel, and position the crank wheel in Tool No. 1. Then install the connecting rod on the shaft. (Fig. 4-17-13)

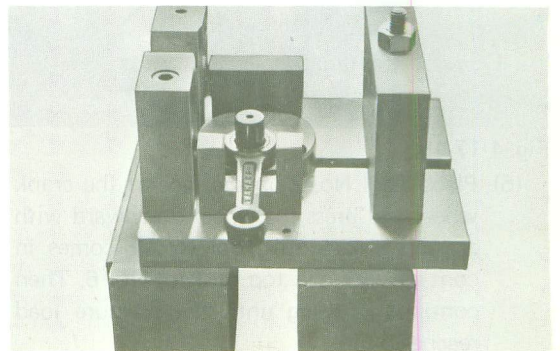

Fig. 4-17-13

- (3) Place the other crank wheel in position and lightly tap it onto the crank pin. Keep the crank wheel horizontal when tapping it in place. Position the slide plate against the rim of the crank wheel, and tap the slide plate until it contacts the crank wheel (to align the crankshaft temporarily) using a brass hammer. (Fig. 4-17-14)

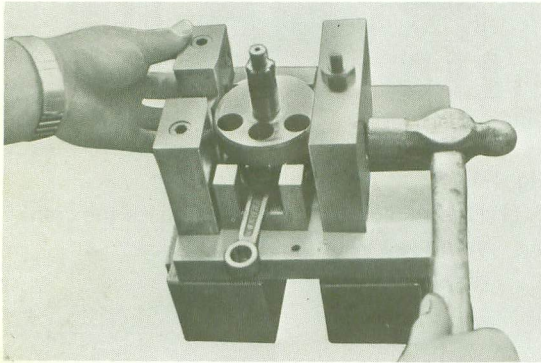

Fig. 4-17-14

**Note:**

When using the hammer, keep the slide plate bolt lock nut loose.

- (4) Tighten the slide plate lock nut fully. (Fig. 4-17-15)

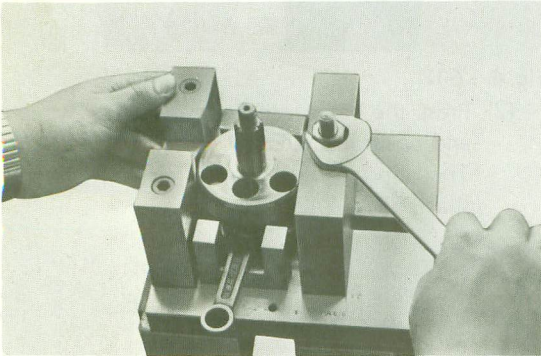

Fig. 4-17-15

- (5) Place Tool No. 2 on the face of the crank wheel and press the wheel downward with a hand press until Tool No. 2 comes in contact with the top of Tool No. 6. Then continue pressing until the pressure load reaches 5 tons.

(Fig. 4-17-16)

(Pressure should be applied in the center line of the crank pin. Fig. 4-17-16)

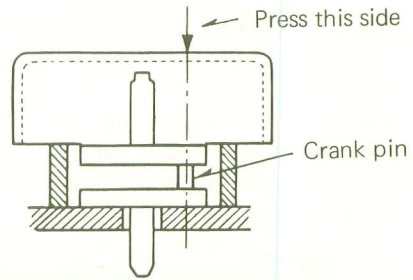

Fig. 4-17-16

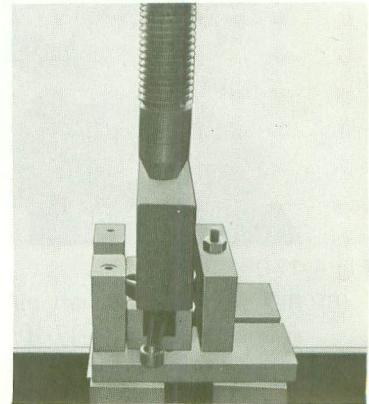

Fig. 4-17-17

- (6) First, install the crank cover over the male center spline. Then join the two crank halves together, making sure the rods are 180° apart. Note that tool No. 5 (crankshaft wedge) is placed between the upper crank wheels to prevent the crank wheels from collapsing against the rods. When you are sure the center splines are mating correctly apply pressure on the order of 10 (+) tons. Remove the crankshaft and check overall width. If overall width is correct the entire crank assembly may now be aligned. (Fig. 4-17-18)

Then align the whole crankshaft ass'y.

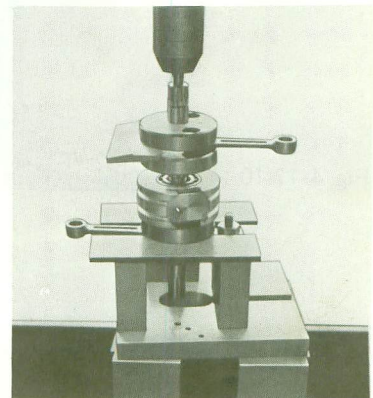

Fig. 4-17-18

#### 4. Aligning Crankshaft Ass'y

(1) Place the crankshaft ass'y on V block or other suitable centering device and check for alignment. (Fig. 4-17-19)

If runout exceeds specified limits, align the crankshaft ass'y

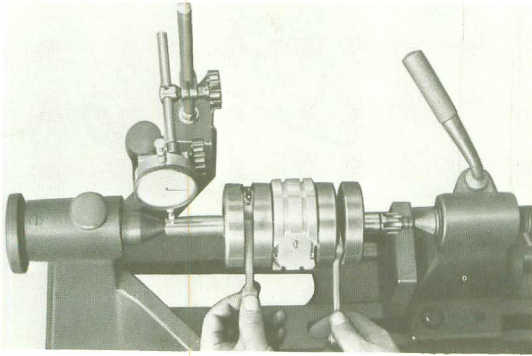

Fig. 4-17-19

(2) To correct crank wheel runout drive a wedge into the gap between the crank wheels, or use a brass hammer to tap the wheels into alignment. (Figs. 4-17-20 and 21)

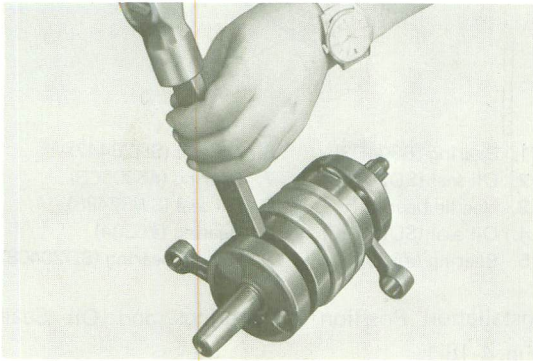

Fig. 4-17-20

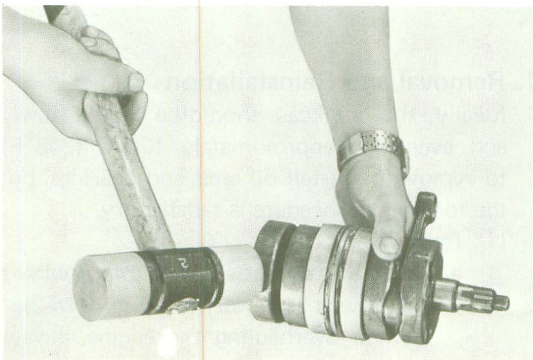

Fig. 4-17-21

#### 5. Accuracy of the Crankshaft Ass'y

(1) Axial Play of the Connecting Rod Small End

(Measure the wear of the crank pin and bearing at the large end of the connecting rod.)

As shown in Fig. 4-17-22, wiggle the connecting rod small end, and check for axial play.

Axial play limits:

- (a) Axial play should be 2 mm or less. (Use a dial gauge.) If the play is more than 2 mm, disassemble the crankshaft and replace defective parts.
- (b) After reconditioning axial play should be between 0.8 mm and 1.0 mm.

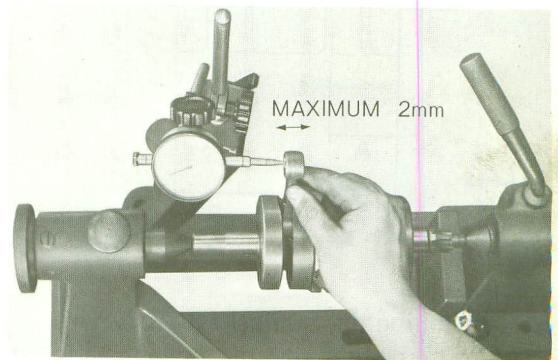

Fig. 4-17-22

(2) Checking the Connection Rod for Large Ebd Side Play. (Fig. 4-17-23)

Hold the connecting rod to one side and insert a feeler gauge between the large end and the crank wheel.

Side Play Limits: 0.1 mm 0.3 mm

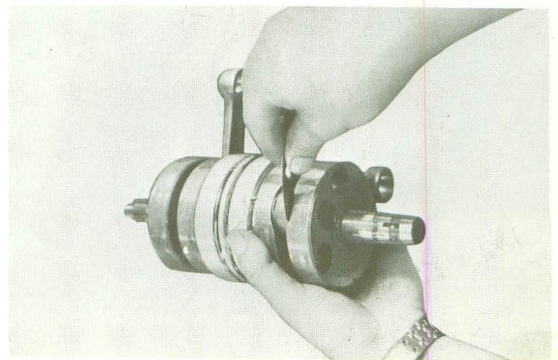

Fig. 4-17-23

(3) Overall Length and Runout of the Crankshaft (Fig. 4-17-24)

Limits:

- (a) Overall length of the Crank
- |        |     |         |
|--------|-----|---------|
| A..... | 47  | -0.05mm |
|        |     | -0.10mm |
| B..... | 140 | -0 mm   |
|        |     | -0.2 mm |
- (b) Runout of the Crankshaft  
0.03mm or less

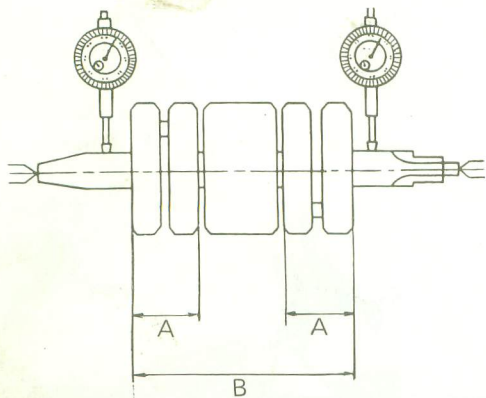

Fig. 4-17-24

### 6. Reinstalling the Crankshaft Ass'y

Put shims on both ends of the crankshaft, and install the crankshaft assembly by using the crankshaft installing tool.

Hold the connecting rod at top dead center with one hand while turning the handle of the installing tool with the other.

(Fig. 4-17-25)

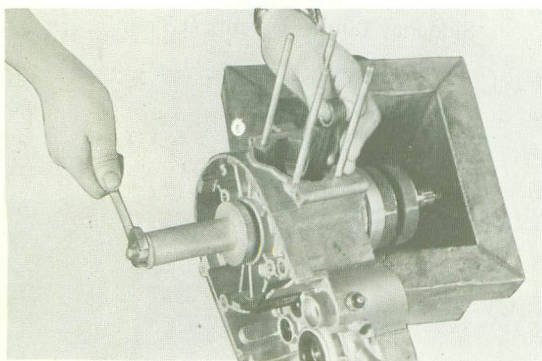
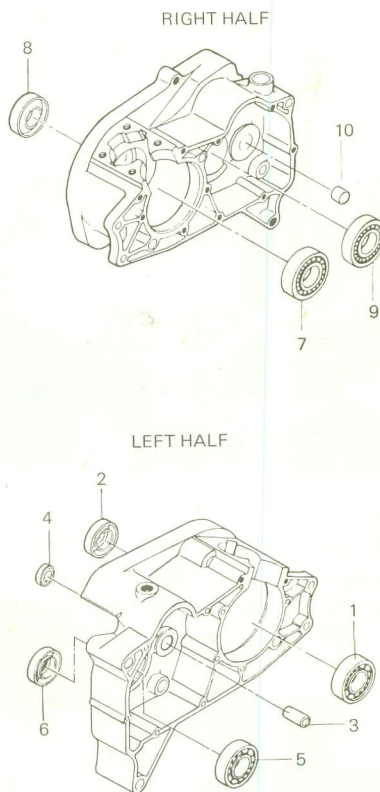

Fig. 4-17-25

## 4-18. Bearings and Oil Seals



- |                       |                              |
|-----------------------|------------------------------|
| 1. Bearing (6304C3)   | 6. Oil seal (SD28447)        |
| 2. Oil seal (SD20408) | 7. Bearing (#6305C3)         |
| 3. Needle bearing     | 8. Oil seal (SW32488)        |
| 4. Oil seal (SD08226) | 9. Bearing (#6304)           |
| 5. Bearing (#6304)    | 10. Needle bearing (SD20408) |

Installation Position of Bearings and Oil Seals  
Fig. 4-18-1

### 1. Removal and Reinstallation

Ideally, the crankcase should be heated slowly and evenly to approximately 120°C (248°F) to remove or install oil seals and bearings, but the following procedure is satisfactory.

#### (1) Removal

- a. Pry the oil seals out of place with a slot-head screwdriver. (Fig. 4-18-2)  
When overhauling the engine, always replace the oil seals.

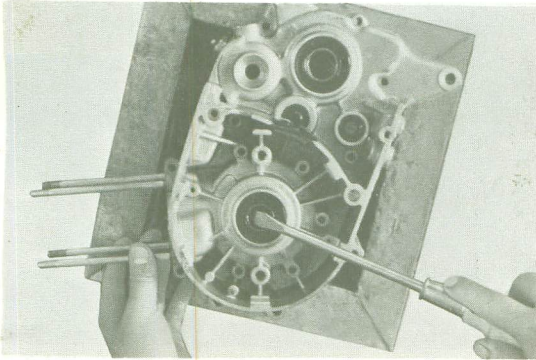

Fig. 4-18-2

- b. Remove the bearings with the bearing removing tool. (Fig. 4-18-3)

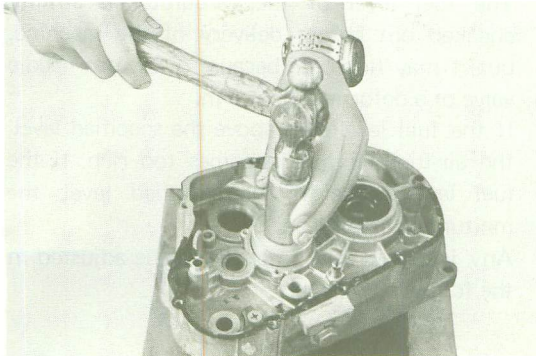

Fig. 4-18-3

(2) Reinstallation

Install all bearings and oil seals, with the stamped marker's mark or numbers facing outward.  
Pack all bearings with an adequate amount of light weight grease before installation.

## 4 19. Carburetors

The YAMAHA 200CS3-B engine is equipped with a pair of AMAL type, MIKUNI VM20SC carburetors.

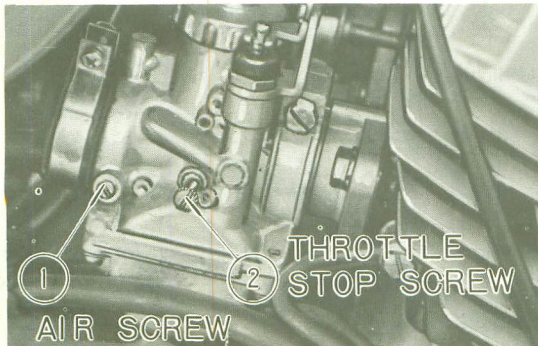

Fig. 4-19-1

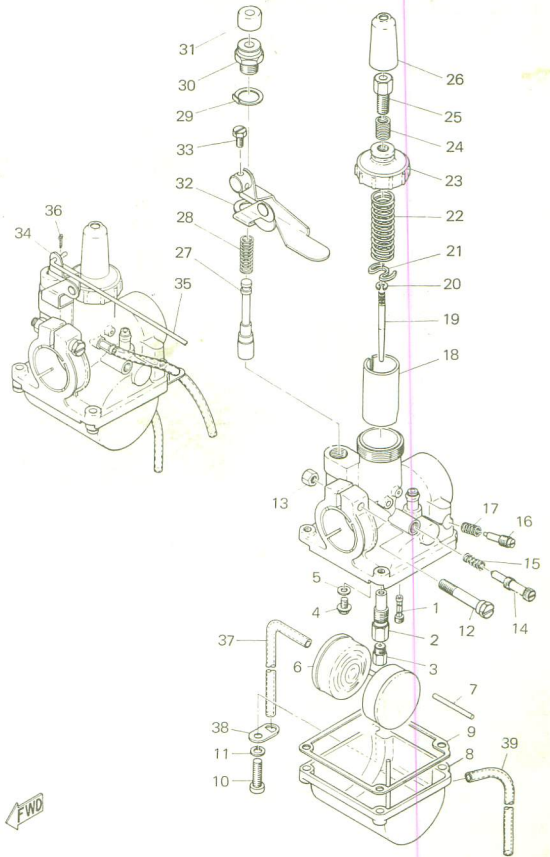

Fig. 4-19-2 Carburetor Components

- |                                |                           |
|--------------------------------|---------------------------|
| 1. Pilot jet                   | 25. Cable adjusting screw |
| 2. Main nozzle                 | 26. Cap                   |
| 3. Main jet                    | 27. Starter plunger       |
| 4. Valve seat ass'y            | 28. Plunger spring        |
| 5. Valve seat washer           | 29. Starter lever plate   |
| 6. Float                       | 30. Plunger cap           |
| 7. Float                       | 31. Plunger cap cover     |
| 8. Float chamber body          | 32. Starter lever (L. H.) |
| 9. Float chamber gasket        | 33. Rod screw             |
| 10. Pan-head screw (4 pcs)     | 34. Starter lever (R. H.) |
| 11. Spring washer (4 pcs)      | 35. Starter lever rod     |
| 12. Body fitting screw         | 36. Cotter pin            |
| 13. Nut                        | 37. Air bent pipe         |
| 14. Throttle stop screw        | 38. Plate                 |
| 15. Throttle stop screw spring | 39. Overflow pipe         |
| 16. Pilot air screw            |                           |
| 17. Pilot air screw spring     |                           |
| 18. Throttle valve             |                           |
| 19. Jet needle clip            |                           |
| 21. Throttle valve spring      |                           |
| 23. Mixing chamber top         |                           |
| 24. Cable adjusting spring     |                           |

## 1. Checking the Carburetor

### (1) Float

If fuel leaks into the float while the engine is running, the float chamber fuel level will rise and make the combustion mixture too rich. Shake the float so you can feel or hear any gasoline inside. Replace the float if it is deformed or leaking.

### (2) Float Valve

Replace the float valve if its seating end is grooved or scratched. Check the float valve spring for fatigue. Depress the float valve with your finger, and make sure it properly seats against the valve seat.

If the float valve spring is weakened, fuel may overflow, flooding the float chamber when the machine is running at certain speeds, or over a certain type of road.

### (3) Overflowing

If fuel overflows, check the carburetor as described in (1) and (2) above. If neither (1) nor (2) cures the overflowing, it may be caused by dust or dirt in the fuel preventing the float valve from seating properly. Remove the dust or dirt in the fuel. (Figs. 4-19-3 and 4)

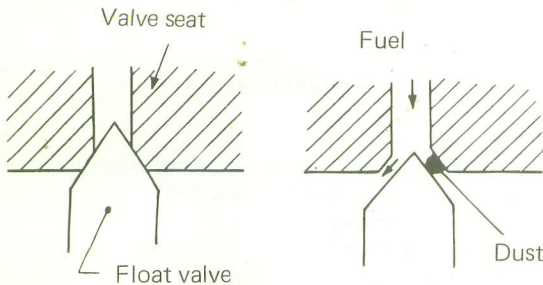

Fig. 4-19-3

Fig. 4-19-4

### (4) Cleaning the Carburetor

Disassemble the carburetor, and wash all its parts in a suitable solvent. Blow all air and fuel passages in the carburetor with compressed air.

All jets and other delicate parts should be cleaned by blowing compressed air through them, because wire or other hard, pointed cleaning tools may damage their precision-machined surfaces.

(Fig. 4-19-5)

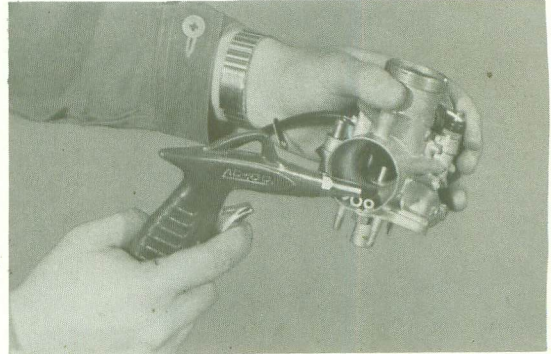

Fig. 4-19-5

## 2. Adjusting the fuel

The fuel level of the carburetor is strictly checked out before delivery of the machine, but it may fluctuate because of a worn needle valve or a deformed float arm.

If the fuel level rises above the specified level, the air-fuel mixture becomes too rich. If the fuel level is below the specified level, the mixture becomes lean.

Any incorrect fuel level should be adjusted in the following manner.

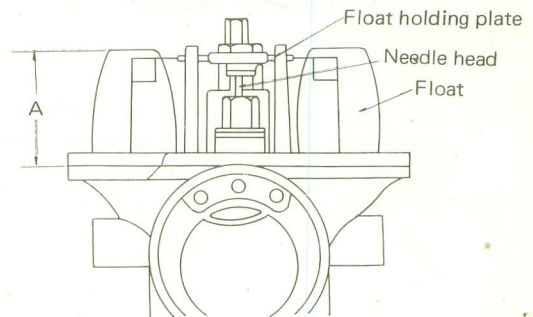

Fig. 4-19-6

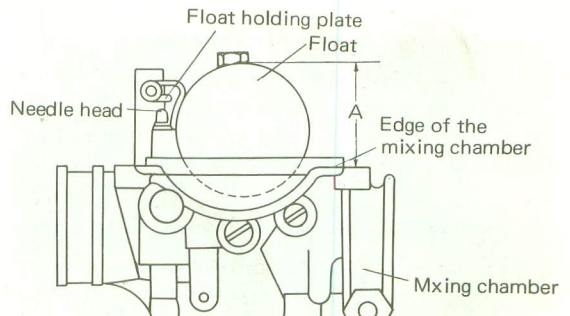

Fig. 4-19-7

- (1) Remove the float chamber body, and invert the mixing chamber body. Slowly push the float downward with your fingers until the float contacts the top of the float needle. Do not push hard enough to compress the valve spring.
- (2) Then measure height A in Fig. 5-19-6 (From the top of the float to the float chamber gasket seat.)  
Standard measurement: 21.7mm
- (3) If A measure more or less than the standard value, bent the tang a little so that a correct measurement is obtained.

### 3. Synchronizing Carburetors

Both cylinders will not pull evenly unless the carburation system for each side is identical. If one slide is higher in the carburetor bore than the other slide, overall poor engine performance will be the result.

- (1) With the engine not running, remove the rubber air filter connectors.
- (2) Twist the throttle grip fully open so that the slides lift completely up.
- (3) Reach into the air intake of both carburetors with the fingers of one hand (a side angle mirror placed in front of the air intakes will also allow the slide positions to be cheked) and feel the top of the bores for the throttle slides.
- (4) Slowly close the throttle grip until the throttle slides just begins to enter the bore.
- (5) Both slides must be synchronized to enter the bore at exactly the same time. If the slide are not synchronized, then make an adjustment at the top of the carburetor, using the cable adjuster, to raise or lower one slide to match the other.

### 4. Adjusting the Idle Spedd

- (1) Turn the throttle stop screws equally, a couple turns, to raise the throttle slides from a fully closed position. This prevents the engine from quitting while the idle speed is being adjusted.
- (2) Start the engine.
- (3) Begin with either carburetor and alternately screw the idle speed screw in, then out. While doing this, take note of the increase

and decrease in engine rpm. At the point where both cylinders are idling at the same speed there will be no increase and decrease in engine rpm for approximately 1/2 ~ 1 turns. At this point the idle rpm may exceed the specified rpm, but this can be corrected by backing off both idle speed screws an equal amount until the rpm's drop to the proper level (1,050 ~ 1,200 rpm's.)

### 5. Carburetor Setting

	Model	CS3-B General
1.	M. J. (Main jet)	#65
2.	N. J. (Needle jet)	N-6
3.	J. N. (Jet needle setting the step where J. N. clip is fitted)	4D10-3
4.	C. A. (Throttle valve cut-away)	2.5
5.	P. J. (Pilot jet)	30
6.	A. S. (Air screw setting—the number of turns the A. S. is backed off from a lightly seated position)	2.0
7.	G. S (Starter jet)	40
8.	Idling Speeds (RPM)	1,050~1,200

### 4-20. Air Cleaners

#### 1. Removal

- (1) Remove the side covers, both right and left.
- (2) Remove the air cleaner mounting bolt and take out the air cleaner case cap. (Fig. 4-20-1)

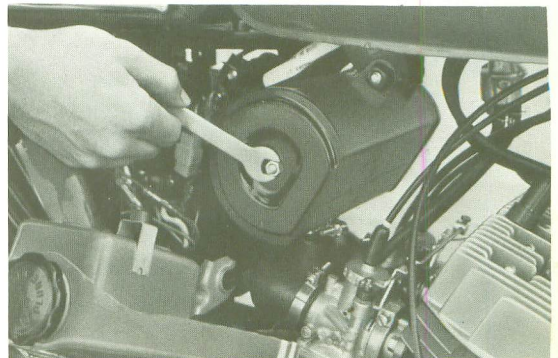

Fig. 4-20-1

- (3) The filter element is the divided type. (Fig. 4-20-2)



Fig. 4-20-2

## **2. Cleaning**

Clean the filter element with compressed air. Because the element is made of filter paper, it should never be exposed to water or oil.

If the element is excessively dirty, it may be cleaned carefully with gasoline.

If possible, the element should be replaced every 3,000 miles (5,000 km).



## CHAPTER 5. CHASSIS

The chassis is of a steel tubing diamond frame structure. The CS3-B has successfully reduced the number of members of the frame, thereby attaining a well-balanced stress distribution. The unique design of the chassis has resulted in lighter weight as well as in improved rigidity and strength.

## 5-1. Front Wheel

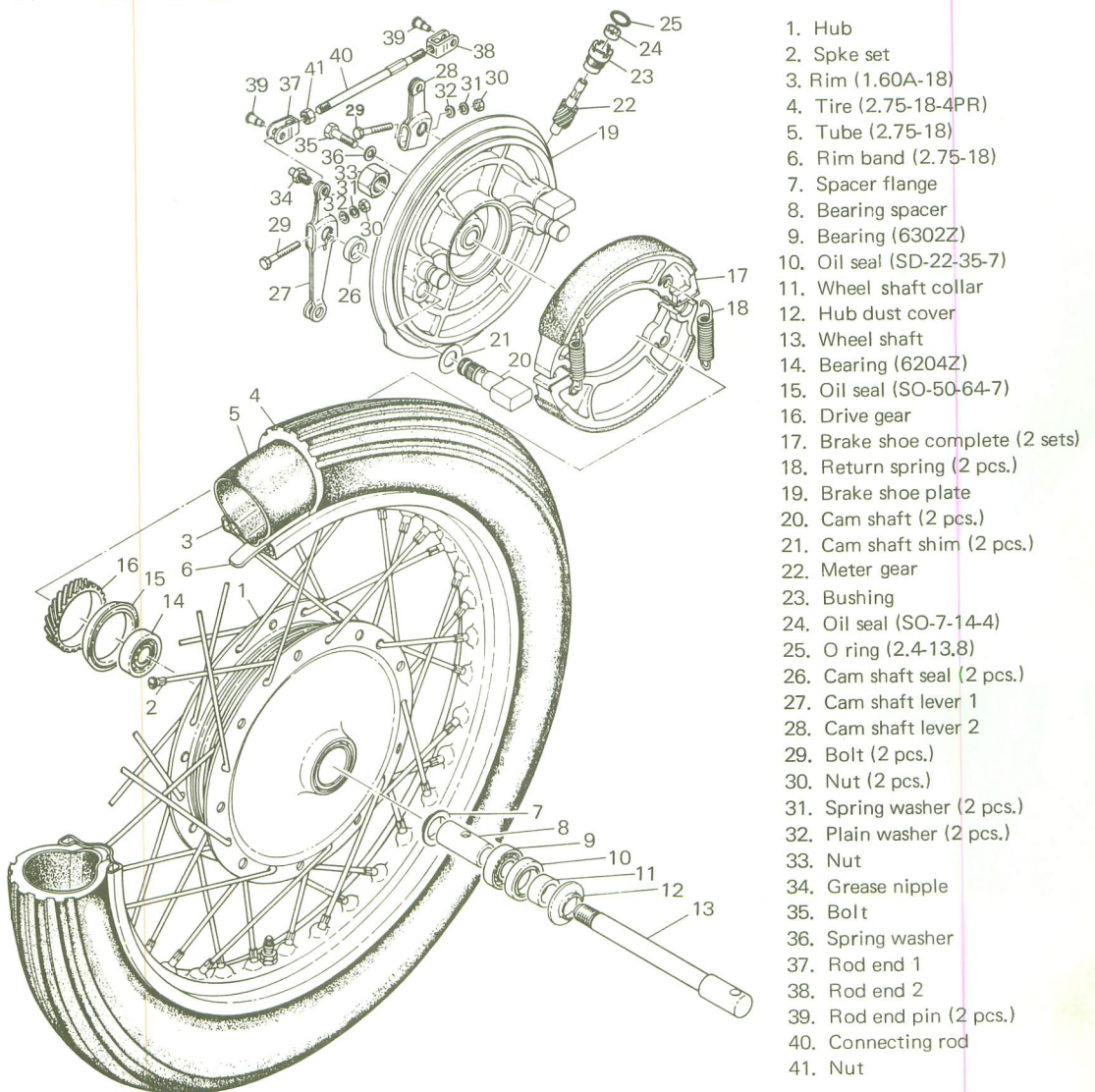

Fig. 5-1-1 Front Wheel Components

### 1. Removal

- (1) Disconnect the brake cable from the front brake shoe plate, and remove the speedometer cable. (Fig. 5-1-2)

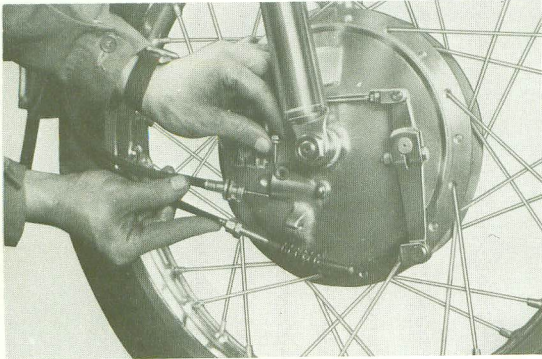

Fig. 5-1-2

- (2) Remove the front wheel shaft nut. (Fig. 5-1-3)

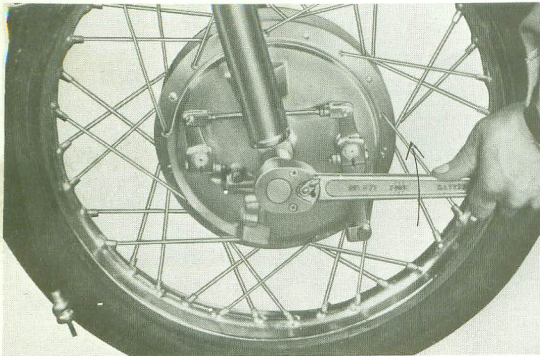

Fig. 5-1-3

- (3) Loosen the front wheel shaft lock bolt. (Fig. 5-1-4)

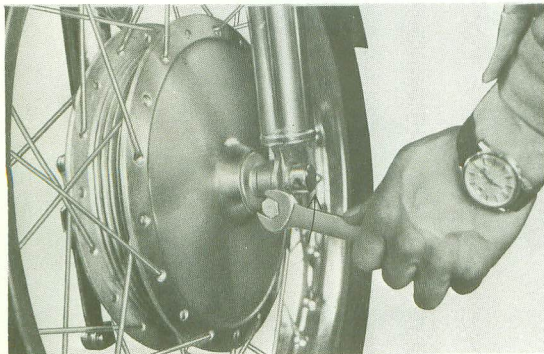

Fig. 5-1-4

- (4) Pull out the shaft. (Fig. 5-1-5)

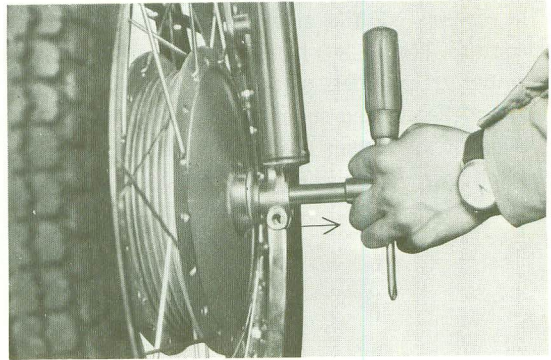

Fig. 5-1-5

- (5) Remove the front wheel ass'y (Fig. 5-1-6)

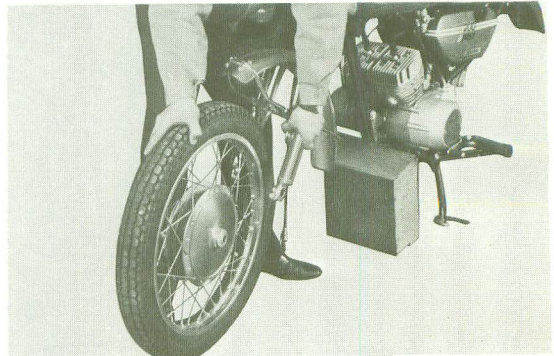

Fig. 5-1-6

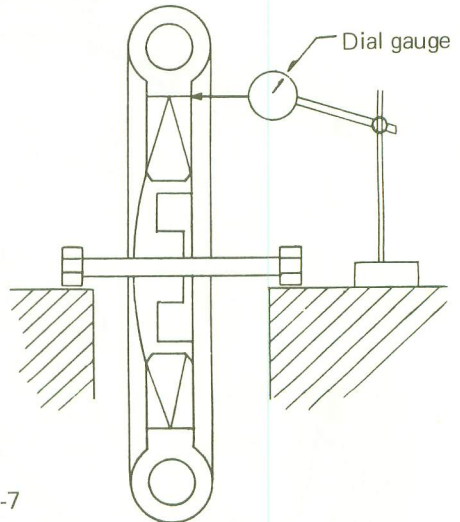

Fig. 5-1-7

### 2. Checking and Adjustment

- (1) Checking the Runout of the Rim  
Anchor the front wheel as shown in Fig. 5-1-7, and measure the runout of the rim with a dial gauge.

Runout limits: 2mm (0.07 in.)

Excessive runout of the rim may cause steering difficulties while riding the machine, which may lead to an accident. Excessive runout may result from a deformed rim or a loosen spoke nipple.

(2) Spokes

a. Replacing Spokes:

When replacing a spoke or lacing up a new wheel it must be noted that there are two different spokes used on the rim assembly. Figure 5-1-8 (left) shows an "outside" spoke and (right) an "inside". When lacing up a new wheel assembly, always install the "inside" spokes first then true the wheel.

After the wheel has been roughly trued, install the outside spokes and align the wheel to final specifications.

(b) Adjusting the spoke tension;

Any loosened spoke or uneven spoke tension may cause the rim to warp.

This may also adversely affect the spoke itself. Spokes tend to become loose after many miles. This is particularly true with a new machine. Therefore, the spokes should be re-tightened periodically.

Retightening should be performed by giving each nipple one turn, beginning with one side of the hub and then the other side.

Spoke nipple tightening torque; 15 kg-cm (1.1 ft-16) (Fig. 5-1-9)

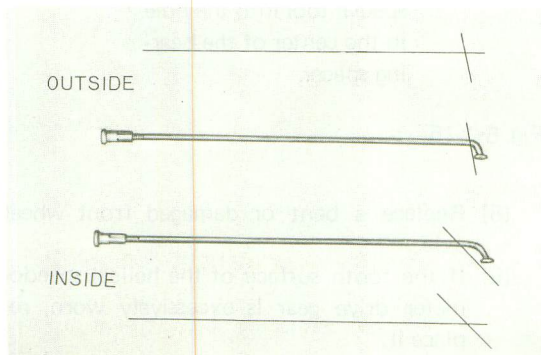

Fig. 5-1-8

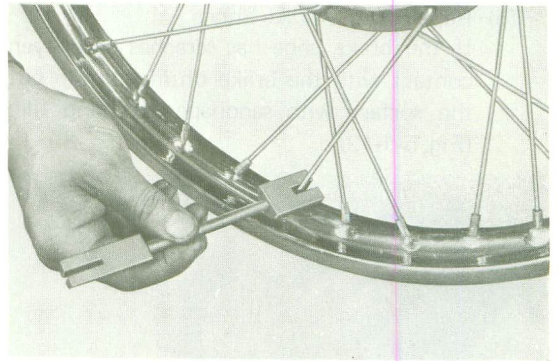

Fig. 5-1-9

(3) Brake Shoe

Set the brake shoe, and measure the outer diameter of the shoe, using a slide calipers, as shown in Fig. 5-1-10. If the shoe is less than 175 mm (6.9 in.), replace it

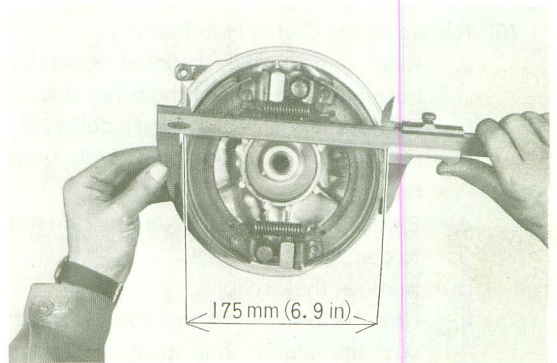

Fig. 5-1-10

(4) Brake Drum

Oil, dust or scratches on the inner surface of the brake drum will result in abnormal noise or a malfunction of the brake. Clean or smooth out the surface with a rag or sandpaper.

(Fig. 5-1-11)

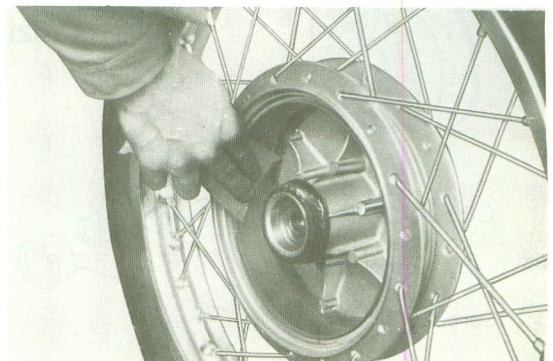

Fig. 5-1-11

(5) Repairing the Brake Shoe

If the brake shoe has scratches or uneven contact with the brake drum, smooth out the surface with sandpaper or hand file. (Fig. 5-1-12)

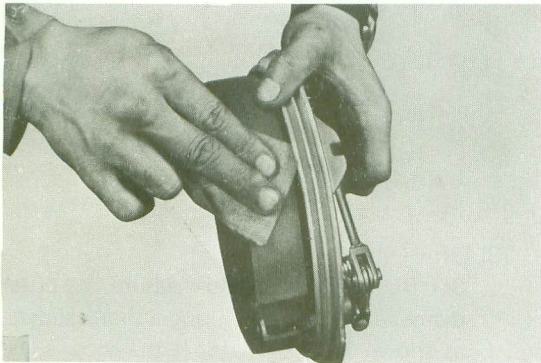

Fig. 5-1-12

(6) Replacing the Clutch Hub Bearing

- a. First remove the sprocket shaft by pushing it out toward the other side.
- b. Remove the sprocket shaft collar. (It can easily be pulled out with your hand.)
- c. Remove the oil seal. Exercise care not to damage the oil seal.
- d. Remove the circlip.
- e. Use the bearing fitting tool to push out the clutch hub bearing toward the sprocket side.
- f. To install the clutch hub bearing, reverse the above sequence. Before installation, grease the bearing and oil seal.

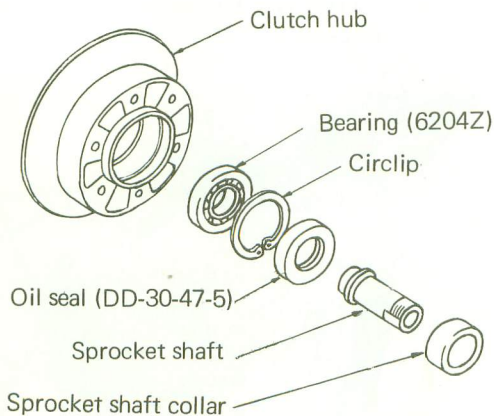

Fig. 5-1-13

(7) Replacing the Wheel Bearing

- a. First, clean the outside of the wheel hub.
- b. Insert the bent end of the special tool (as shown in Fig. 5-1-15) into the hole in the center of the bearing spacer, and drive the spacer out of the hub by tapping the other end of the special tool with a hammer. (Both bearing spacer and spacer flange can easily be removed.)
- c. Push out the bearing on the other side.
- d. To install the wheel bearing, reverse the above sequence. Be sure to grease the bearing before installation and use the bearing fitting tool (furnished by Yamaha.).

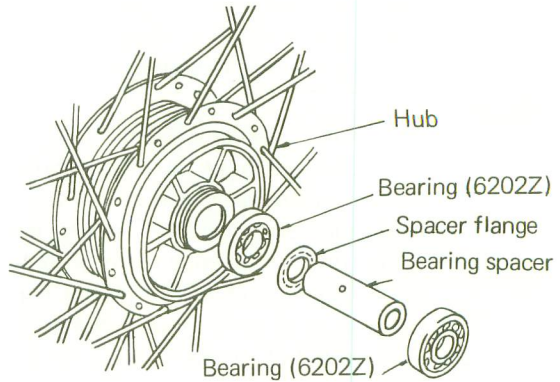
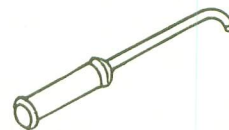

Fig. 5-1-14



Insert the bent end of the special tool into the hole in the center of the bearing spacer.

Fig. 5-1-15

- (8) Replace a bent or damaged front wheel axle.
- (9) If the tooth surface of the helical speedometer drive gear is excessively worn, replace it.
- (10) Check the lips of the seals for damage or warpage. Replace if necessary.

5-2. Rear Wheel

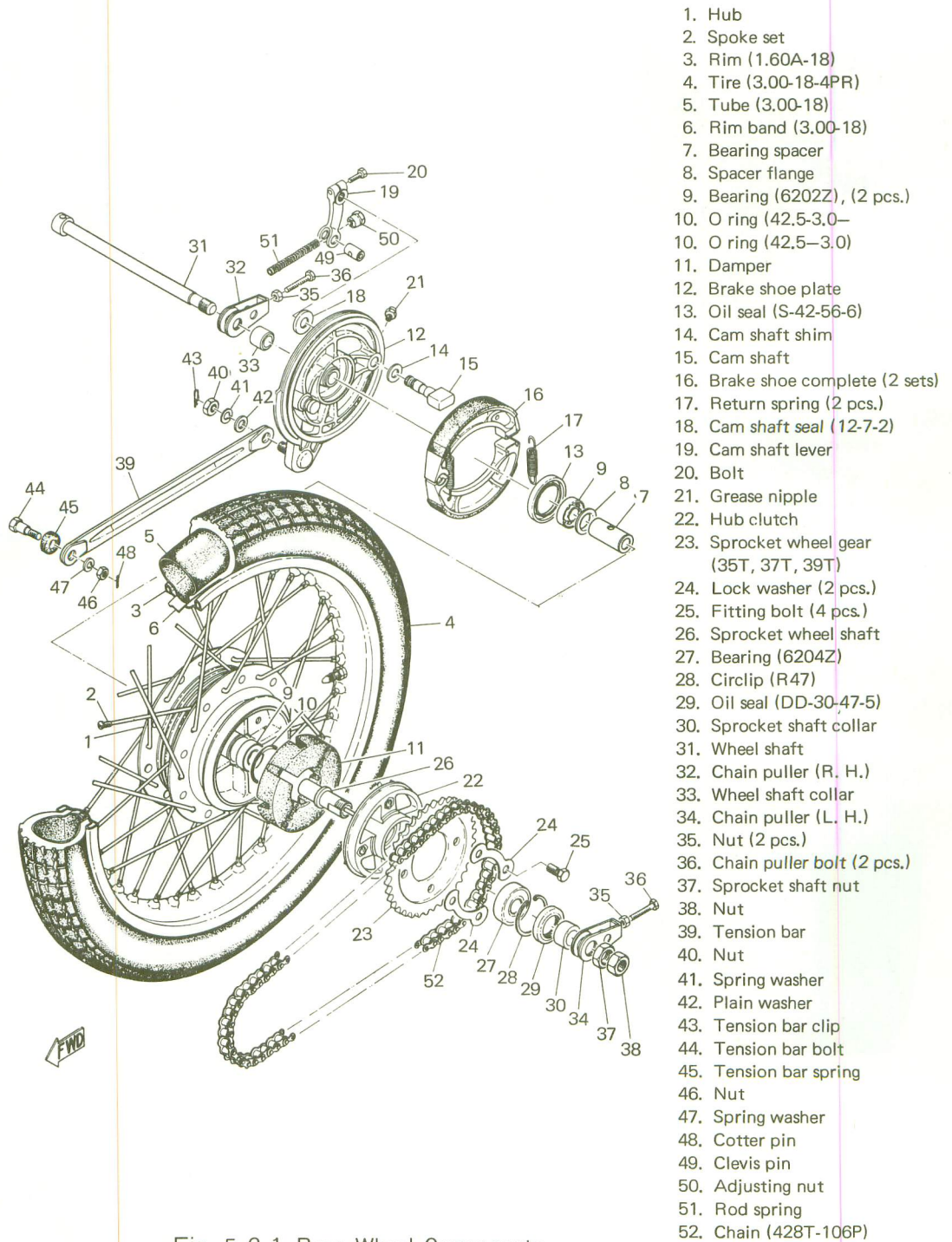

Fig. 5-2-1 Rear Wheel Components

1. Removal

(1) Remove the tension bar (anchor bar) and brake rod from the rear brake shoe plate. (Figs. 5-2-2, 3 and 4)

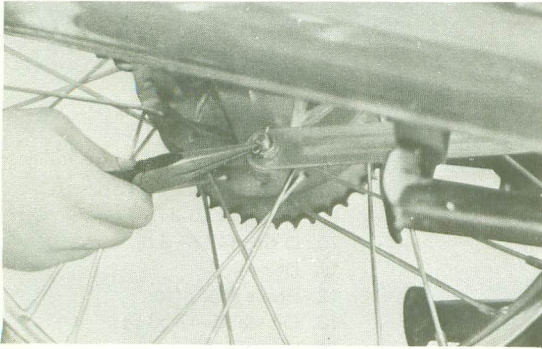

Fig. 5-2-2

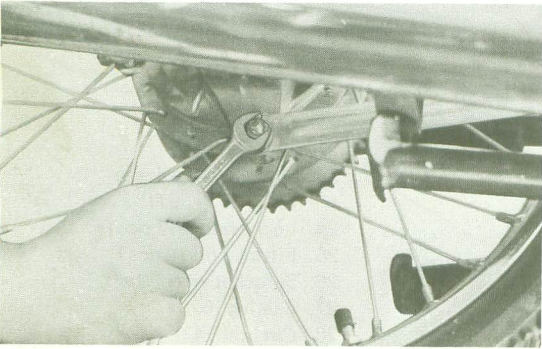

Fig 5-2-3

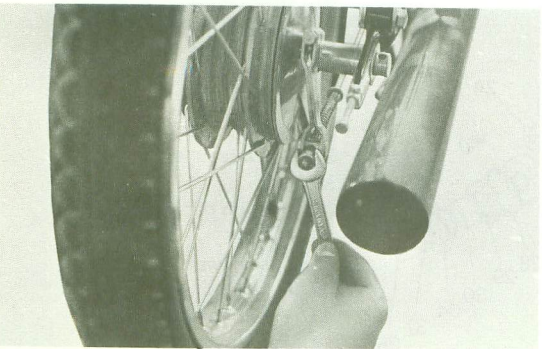

Fig. 5-2-4

(2) Remove the rear wheel shaft nut, and pull out the shaft. (Figs. 5-2-5- and 6)

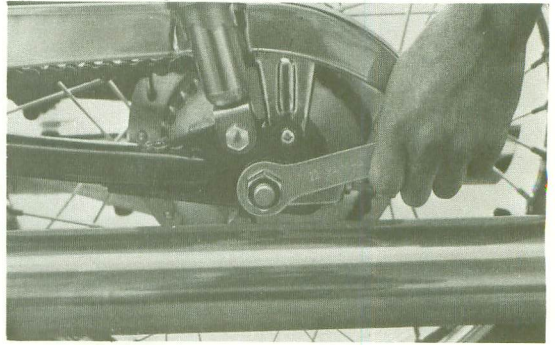

Fig. 5-2-5

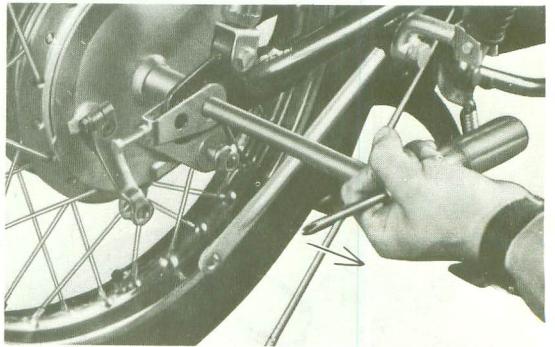

Fig. 5-2-6

(3) Remove the distance collar. (Fig. 5-2-7)

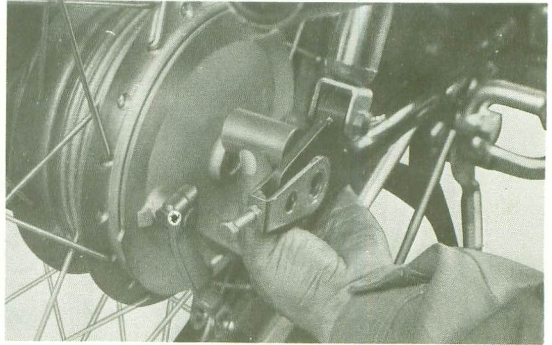

Fig. 5-2-7

(4) Remove the rear wheel ass'y (Fig. 5-2-8)



Fig. 5-2-8

## 2. Checking and Adjustment

- (1) Runout of the Rim  
Check the rim in the same manner as in the case of the front wheel. Runout limits- 2 mm or less.
- (2) Brake Shoe  
Check the brake in the same manner as in the case of the front wheel.
- (3) Brake Drum  
Check the brake in the same manner as in the case of the front wheel.
- (4) Repairing the Brake Shoe  
Repair the brake shoe in the same manner as in the case of the front wheel.

## 5-3. Replacing Tires

- (1) Removal
  - a. Remove the valve cap and lock nut from the tire valve, and deflate the tire.
  - b. Remove the tire from the wheel rim by the use of two tire levers. (Exercise care to avoid damaging the inner tube with the levers.)
- (2) Installation
  - a. Replace the tube between the tire and the wheel rim, and inflate the tube half. Be sure that the valve stem is directed toward the wheel shaft.
  - b. Mount the tire on the wheel rim by the use of tire levers. For this operation, it is advisable that the head on one side of the tire be pushed in toward the rim flange.
  - c. To avoid pinching the tube between the tire and the rim, tap the tire with a hammer.
  - d. Tighten the tire valve lock nut, and inflate the tire to the recommended pressure then install the valve cap.

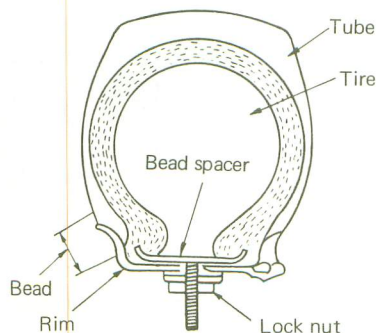

Fig. 5-3-1

## 5-4. Rear Sprocket Wheel

### 1. Removal

- (1) Disconnect the chain joint and remove the chain. (Fig. 5-4-1)

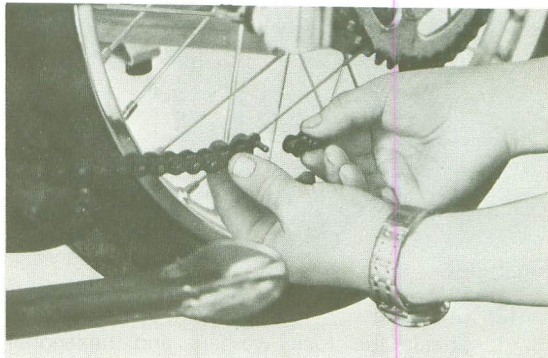

Fig. 5-4-1

- (2) Remove the sprocket shaft nut, then the sprocket. (Fig. 5-4-2)

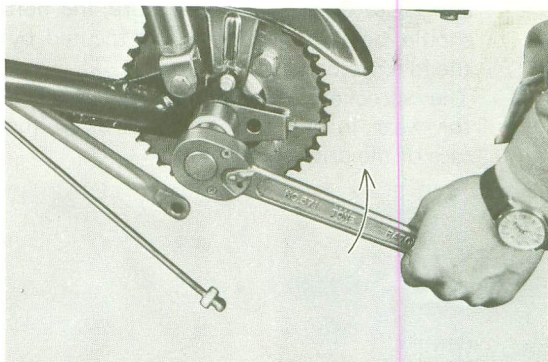

Fig. 5-4-2

### 2. Checking and Adjustment

The rear sprocket wheel is installed on the clutch hub. To replace the sprocket, take the following steps. (Fig. 5-4-3)

- (1) Remove the sprocket.
  - a. Flatten the lock washer.

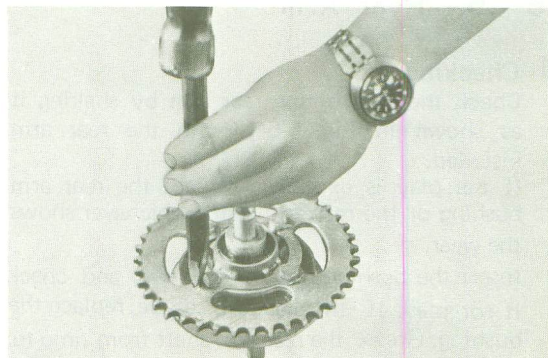

Fig. 5-4-3

- b. Remove the sprocket mounting bolts.  
(Fig. 5-4-4)

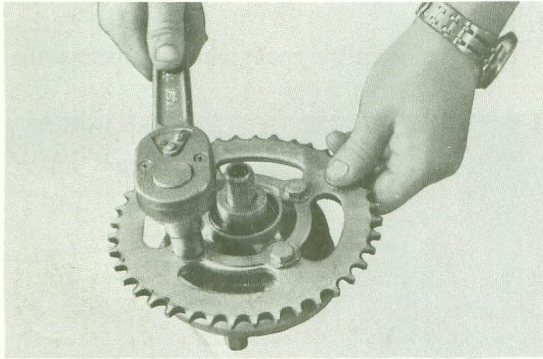

Fig. 5-4-4

(2) Checking

Check the lock washers and hexagonal bolts for breakage and damage. If the sprocket wheel lock washer is damaged or not bent to lock the hexagonal bolt, the bolt may come loose while travelling and cause an accident. Therefore, the bolt should be fully tightened and secured by the lock washer.

The sprocket wheel should be checked for wear in the same manner as in the case of the drive sprocket.

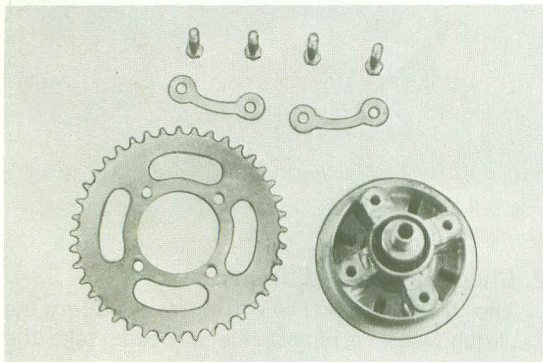

Fig. 5-4-5

## 5-5. Rear Arm

### 1. Checking

Check the play of the rear arm by shaking it as shown in Fig. 5-5-1, with the rear arm installed.

If the play is excessive, replace the rear arm bushing or the rear arm shaft, whichever shows the wear.

Insert the bushing into the rear arm, and check it for play. If the play is excessive, replace the bushing. Grease the rear arm shaft from time to time.

### REPLACING REAR SWING ARM BUSHINGS

On motorcycles being habitually used for on-the-street riding, rear swing arm bushings should be replaced every 10,000 km (6,000 miles.)

The same may not apply to those used for racing or rough riding. Replacement should be made according to machine condition such as excessive play of the rear swing arm, or hard steering, (wander, shimmy, or rear wheel hop, or upon request of the customer.)

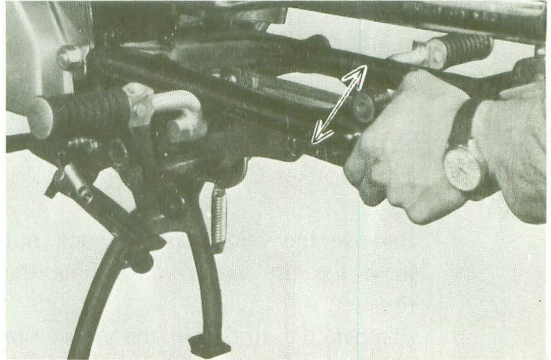

Fig. 5-5-1

## 5-6. Fuel Tank

### 1. Removal

- (1) Drain the fuel tank.
- (2) Disconnect the cross over pipe.
- (3) Remove the seat.
- (4) Remove the tank mounting bolt.  
(Fig. 5-6-1)

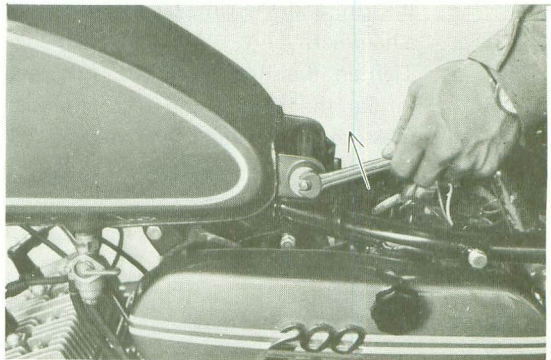

Fig. 5-6-1

- (5) Raise the rear of the tank and slide it rearward then lift it off the machine.  
(Fig. 5-6-2)



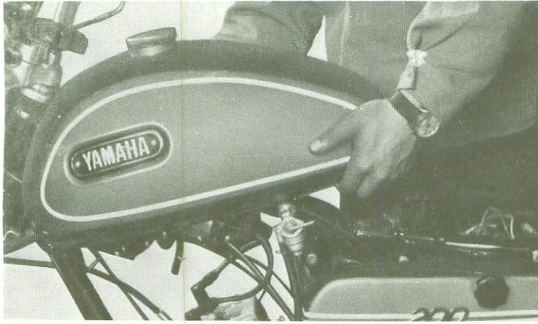

Fig. 5-6-2

## 5-7. Front Fork

### 1. Removal

- (1) Remove the front fender, and remove the inner tube cap bolt.
- (2) Loosen the inner tube clamping bolt on the underbracket. (Fig.5-7-1)

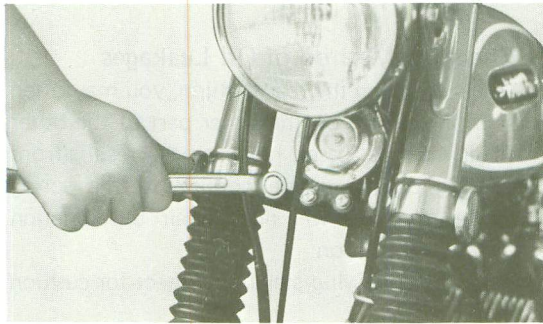

Fig. 5-7-1

- (3) Draw the outer tube downward to remove the assembly. (Fig.5-7-2)

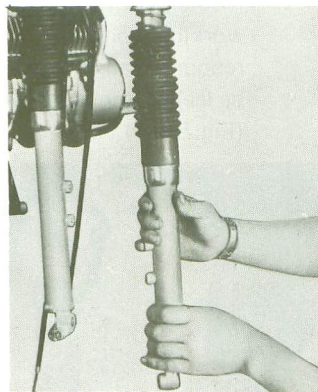

Fig.5-7-2

### 2. Disassembling the Outer and inner Tubes

- a. Wind a rubber sheet or a tire tube around the outer tube nut, and remove the nut. Disassemble the tubes in the manner as shown in Figs. 5-7-3 or 4.

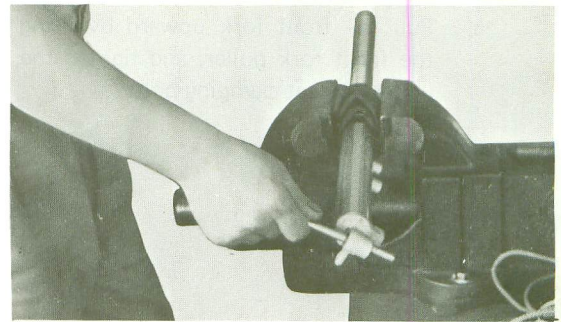
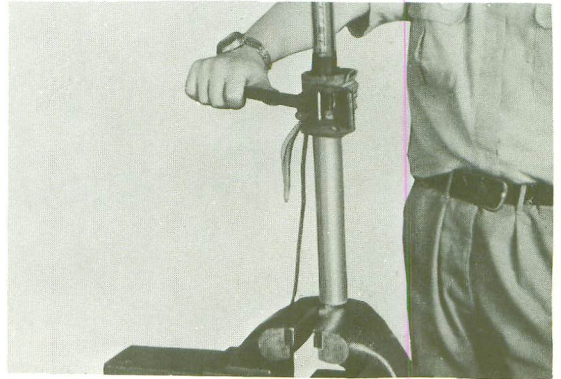

Fig.5-7-4

### 3. Checking

#### (1) Inner Tube

Check the inner tube for any bend or scratches. A minor bend may be corrected, but replacement is preferred.

#### (2) Oil Seal

When disassembling the front fork, be sure to replace the oil seal, and "O" ring.

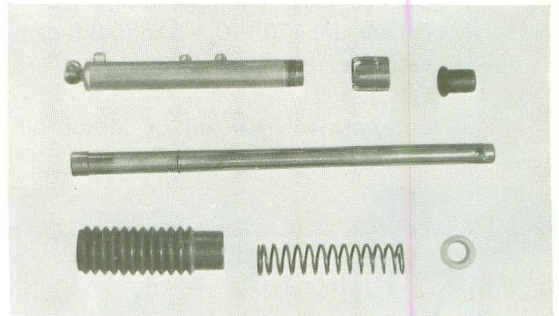

Fig. 5-7-5

### 4. Reassembling

#### (1) Reassembling the Front Fork (with-out mounting on the chassis)

To reassemble the front fork, reverse the sequence of disassembling as mentioned above.

After reassembling, check to see if the inner tube slides smoothly. (Fig. 5-7-6)

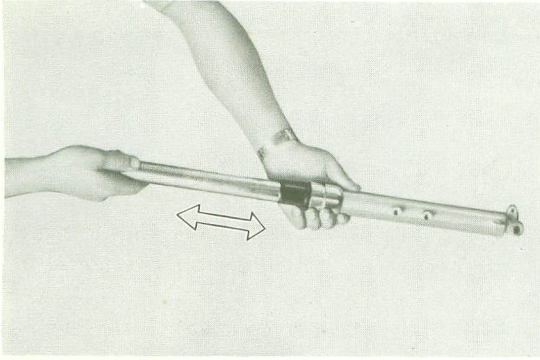

Fig. 5-7-6

(2) Mounting the Front Fork on the Chassis

- a. Pull the front fork upward by using the front fork puller, and tighten the under-bracket clamping bolt.

(Fig. 5-7-7)

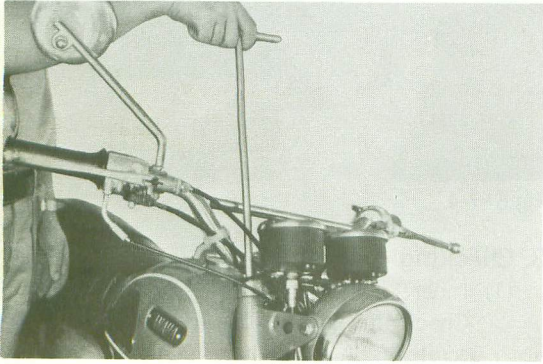

Fig. 5-7-7

- b. Fill the inner tube with the specified front fork oil, pouring through the top end opening of the tube. (Fig. 5-7-8)

Oil amount  $170 + 10, - 5$  cc (5.8 fl-oz.) each side.

Oil

YAMAHA gear oil or Motor oil  
SAE 10W/30

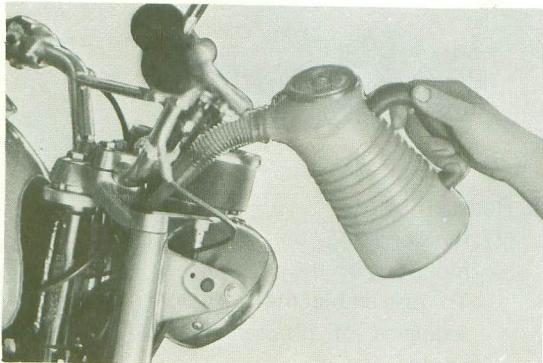

Fig. 5-7-8

- c. Install the inner tube cap bolt, and tighten it. (Fig. 5-7-9)

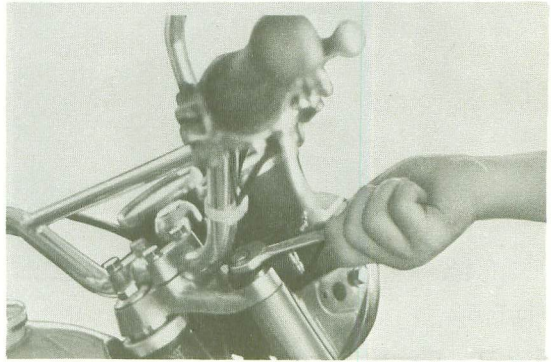

Fig. 5-7-9

## 5-8. Rear Cushion

The rear cushion is not designed to be disassembled, so this paragraph discusses how to check for oil leakages.

### 1. Checking Method of Oil Leakages

When checking the rear cushion, you may often find oil seepage on the lower part of the outer cover. In most cases, however, this results from melting of the grease applied to the spring inside, and this will not impair the function of the rear cushion.

Take the following steps to inspect for cushion oil leakages.

- (1) Remove the rear cushion, and repeatedly depress the cushion a few times. If the spring quickly rebounds half-way, and slowly the last 10 mm, the cushion is in good working condition. If the spring quickly rebounds all the way, the cushion must be leaky. Replace it with a new one.

(Fig. 5-8-1)

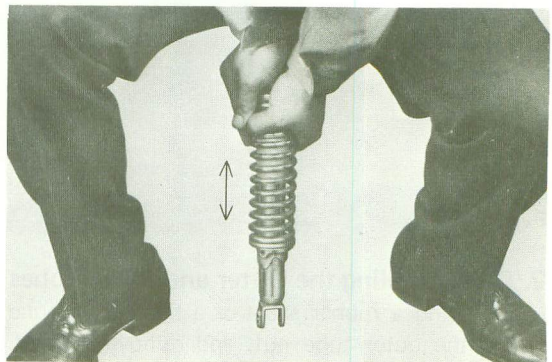

Fig. 5-8-1

## CHAPTER 6. ELECTRICAL

### 6-1. YAMAHA 200 CS3-B Electrical Equipment

The YAMAHA 200 CS3B is equipped with a large-sized starter dynamo, which serves as a high output D-C generator as well as a starter. This enables all electrical terminals to maintain almost constant voltage at all times regardless of engine speeds. All electrical parts are of 12-V capacity.

### 6-2. Main Components

#### 1. Ignition System

This system starts the engine by using the spark plug to ignite the compressed air-fuel mixture in the cylinders. The main components consist of:

Contact breaker (connected to the dynamo)

Condenser (connected to the dynamo)

Ignition coil, spark plug, high tension lead and battery (which is the power source for the primary electric current).

#### 2. Charging and Starting Systems

Charging system:

The purpose of the charging system is to charge the battery which is the power source for engine starting and all electrical equipment (lights, horn, etc.) while the machine is running.

Starting system:

This system is used for cranking the engine.

The main parts of these two systems are:

Dynamo (yoke, armature, brushes), regulator (with cutout relay), starter button (with starting switch), fuse and battery (power source.)

#### 3. Lighting and Signal Systems

The lighting and signal systems consist of signal lights, switch and meter lights (signal system) and illumination lights for night travel.

Signal system:

Horn, flasher lights (flasher relay), stop light, neutral light, and switches.

Lighting system:

Headlight, taillight, and meter lights.

6-3. Connection Diagram

200 CS3-B CONNECTION DIAGRAM

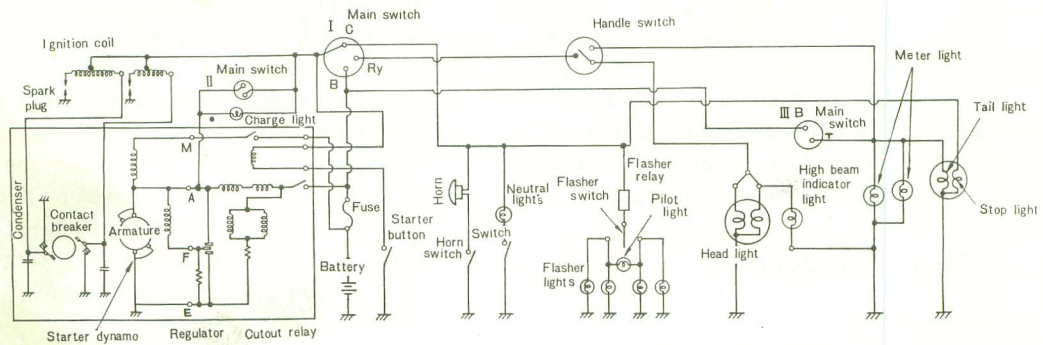

Fig. 6-3-1

6-4. Electrical Parts List

Part Name	Maker	Type & Model	Remarks
Starter dynamo	Mitsubishi Elec. Hitachi	CE-HR, GS214	
Neutral switch	Asahi Denso	YN9	
Spark plug	NGK	B-9HC	
Regulator	Mitsubishi Elec.	RC2333V	
Ignition coil	Diamond Elec., Hitachi	TU-25, C11	
Horn	Nikko Kinzoku	YP-12	
Battery	Furukawa Denchi	12N9-3A-1, 12V 9AH	
Fuse holder	Osachi Mfg.	20A	
Flasher relay	Nippon Denso	B8,	
Stop switch	Asahi Denso	YST2	
Headlight	Koito Mfg.	12V 35W/25W	
Speedometer	Nippon Seiki	YA116	
Tachometer	Nippon Seiki	YA116	
Main switch	Asahi Denso	R3M-001	
Front flasher light	Imasen Elec.	12V 27W(S.A.E.1156)	
Handle switch	Asahi Denso	AG17-002 (L) AG17-001 (R)	
Taillight, Stop light	Stanley Elec.	12V 7W, 23W	
Rear flasher light	Imasen Elec.	12V 27W(S.A.E.1156)	

## 6-5. Starter Dynamo

The dynamo ass'y is made up of the yoke ass'y (field coil, contact breaker, condenser, etc.), the armature ass'y (armature coil, commutator) and the cam ass'y. It supplies power to the ignition and charging systems.

### IGNITION SYSTEM

The ignition system consists of the contact breaker, condenser, and cam. The system interrupts the current flowing from the battery to the primary coil, thereby inducing a high voltage of current in the secondary coil.

#### (1) Contact Breaker Ass'y

Incorrect ignition timing results in irregular engine speeds, thereby causing engine knocking or vibrations. It also causes loss of engine power or engine overheating, thus shortening engine life. Check the contact breaker point gap periodically.

#### (2) Condenser

The condenser stores electricity from the breaker points when they open, and discharges it back into the system when the points close. It prevents sparking between the points, minimizing burning by absorbing abrupt increase in electricity when the breaker points open, and it amplifies the effect of the primary ignition coil.

### CHARGING SYSTEM

The charging system of the starter dynamo consists of the yoke ass'y (shunt field coil and brushes) and the armature ass'y (commutator). The armature coil cuts through the magnetic lines of force of the field coil as the engine runs so that a flow of alternating current is induced. The alternating current is converted into a direct current through the commutator brushes. The voltage of the direct current is kept constant by the voltage regulator, and supplied to each load of the ignition, lighting and signal systems as well as to the battery.

### STARTING SYSTEM

In the starting system of the starter dynamo, the series coil and the armature, as a D-C motor, generate a great amount of torque, by which the engine is cranked.

## 1. Inspection and Repairs

### A. Checking the Dynamo

First, disconnect the wires from terminals A (white) and F (green), then ground the terminal F to (E)...(black), with a copper wire. Connect the positive lead of the tester to the terminal A (white), and ground the negative tester lead to the frame. Start the engine and keep it running at 1,700 rpm.

If the electricity generated reads more than 10V on the tester, the generator is in good working condition.

### Caution:

Do not run the engine at more than 1,700 rpm in this test. If you run the engine at more than 1,700 rpm, a high voltage current generated will ruin the coil, lead wire, etc. (Fig.6-5-1)

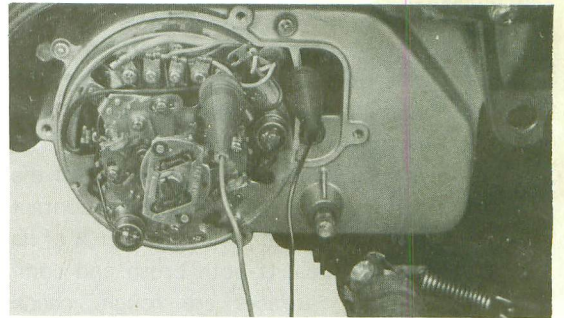

Fig. 6-5-1

### B. Checking the Yoke Ass'y

Clean the yoke with a rag to remove dust, oil and dirt from brush wear, etc.

#### (1) Field Coil Brush Insulation Test

The positive brush of the field coil is insulated from the yoke, and by using the tester you can check its insulation, as shown in Fig.6-5-2. If the insulation is bad, the circuit between the field coil, or the brush holder, and the yoke is shorted. (**Note:** The negative brush is not insulated.)

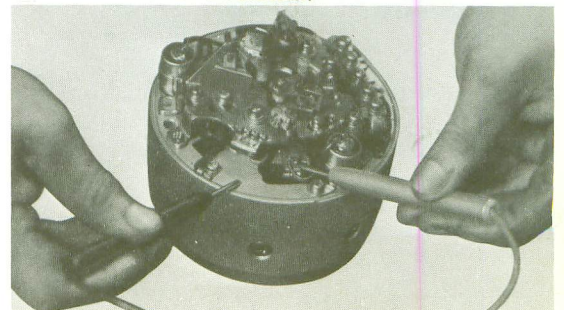

Fig. 6-5-2

(2) Conductivity Test of Field Coil

Check the conductivity between terminals M, A, and F. If conductivity is bad, the field coil is broken. Check the coil connections. If the coil is broken inside, replace it because repairs are difficult. (Fig. 6-5-3)

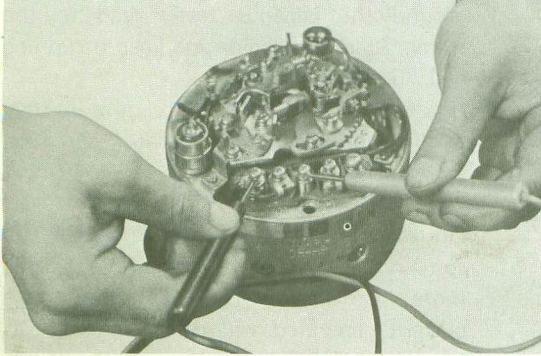

Fig. 6-5-3

(3) Checking the Brushes

The brushes are one of the most important parts in the dynamo. Remove the brushes and check their surfaces for the condition of contact with the commutator. Each brush must contact the commutator in more than  $\frac{3}{4}$  of its surface area. If both brush and commutator surfaces are rough, check both crankshaft and armature for alignment. Smooth down any burrs on the edge of the armature's tapered bore, and clean it thoroughly. If either brush is worn past the minimum length mark, replace them both with new ones. (Fig. 6-5-4)

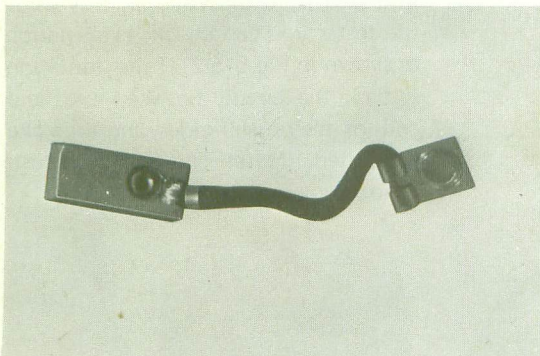

Fig. 6-5-4

(4) Materials of the Brush

Use the brush having the Model No. "6R-1" on its side.

(5) Handling the Brushes

When replacing the brushes, be sure the braided lead of the positive brush does not touch the edge of the breaker plate or brush holder, and that the lead of the negative brush does not touch the positive brush spring. The friction of the braided lead against other parts as a result of vibrations may wear their insulation and cause a short-circuit.

C. Checking the Armature Ass'y

(1) Thoroughly clean the commutator of oil and dirt. If the commutator is rough or dulled with brush dust, polish it with fine grain sandpaper (#400 ~ 600) as shown in Fig. 6-5-5, by rotating the armature in order to polish its surface evenly.

Partial or inaccurate polishing will only deform the commutator and shorten brush life.

If the commutator is burned, out of round, or too rough to be sandpapered, turn it in a lathe no more than 2 mm under the standard 40 mm diameter.

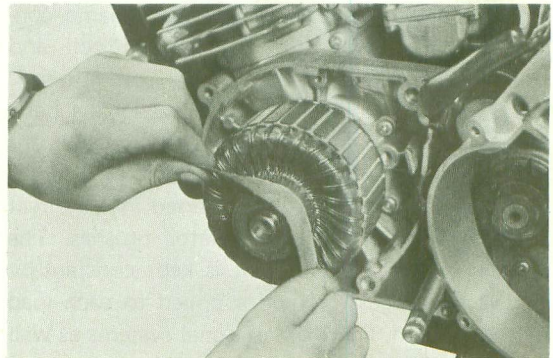

Fig. 6-5-5

(2) Checking the Commutator Mica Under-Cut

If the commutator is worn and if it has high mica, the mica should be undercut with a saw blade.

Sand off all burrs with sandpaper. Be sure the mica is cut away clean between segments, leaving no thin edge next to the segments. (Fig. 6-5-6)

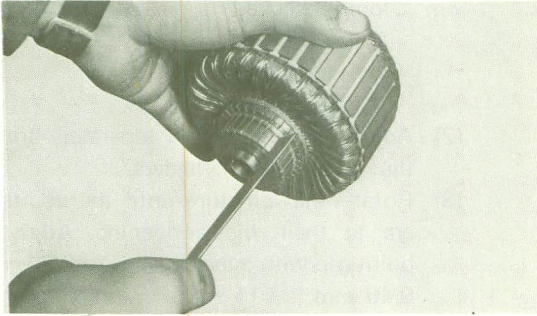

Fig. 6-5-6

- (3) Checking the Armature for Insulation  
If there is electrical leakage between the commutator and shaft, replace the whole armature. (Fig. 6-5-7)

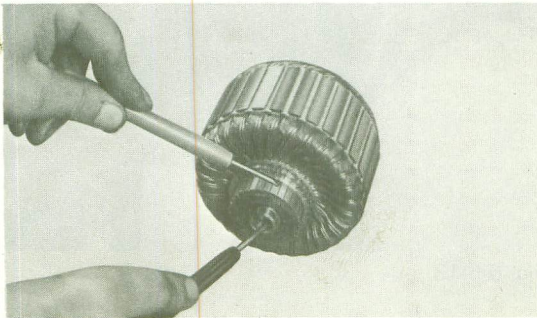

Fig. 6-5-7

- (4) If the field coil is perfectly insulated and conductivity is also good, but the dynamo still will not generate electricity, then the core of the armature coil must be short circuited. Check the armature with a growler at a special service shop.

#### D. Checking the Condenser

##### (1) Insulation Tests

Hook up an electro tester (service tester) for the insulation resistance test, and attach the tester terminals to those of the condenser. If the tester needle swings once and then returns to its original position, the condenser is in good condition. Condenser leakage will hold the needle at a maximum reading. If the reading is more than  $3M\Omega$ , ground the condenser terminals to discharge electricity. (Figs. 6-5-8 and 9)

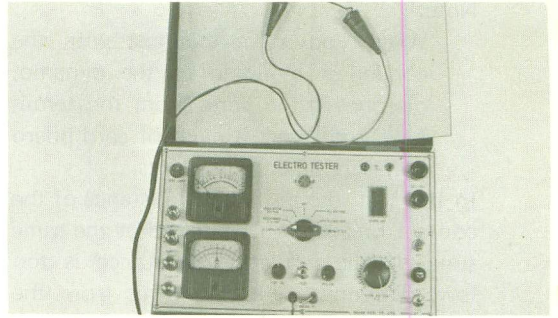

Fig. 6-5-8

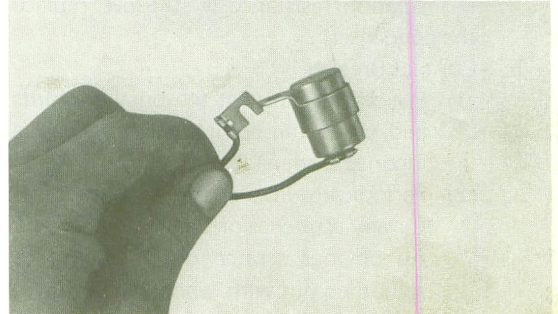

Fig. 6-5-9

##### (2) Capacity Tests

Set the electro tester to the condenser capacity position and connect its terminals to those of the condenser.

Condenser capacity should be no more than  $0.22 \mu F \pm 10\%$ , so before testing the condenser, adjust the capacity of the electro tester. (Figs. 6-5-10 and 11)

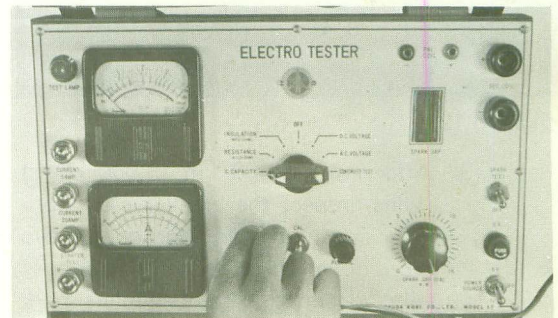

Fig. 6-5-10

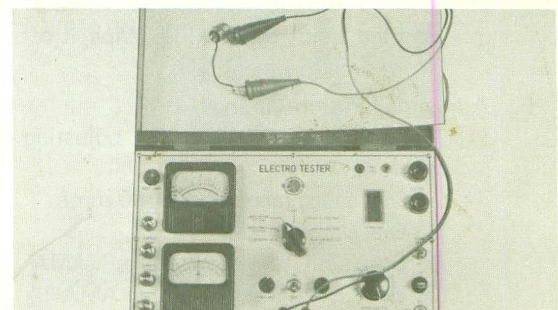

Fig. 6-5-11

**Note:**

When you make this test with the condenser mounted on the dynamo, disconnect the wires from the terminals, and insert a piece of card board between the breaker points.

In this test, the insulation resistance of the contact breaker can be tested at the same time. If the insulation resistance is too low, disconnect the lead wires from the condenser, and test it again.

If insulation resistance is still low, replace the condenser.

**E. Contact Breaker**

(1) Periodically inspect the breaker points and check the point gap. If the gap is incorrect, adjust it.

(2) Periodically inspect the breaker points for any scratches or pits.

An obvious scratch or pit should be smoothed out with sandpaper (#400 ~ 600), and wiped off with soft cloth. (Fig. 6-5-12)

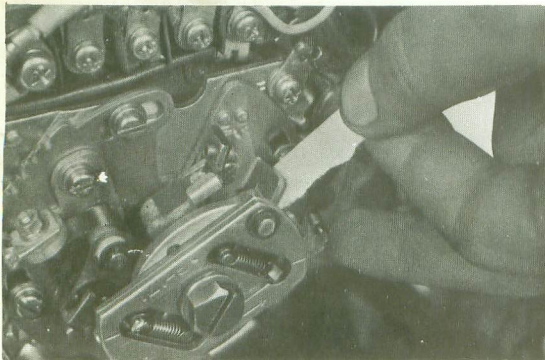

Fig. 6-5-12

(3) After every 5,000 km (3,000 miles) riding, inspect the breaker cam lubricator and if it is dry, add one or two drops of light oil to the lubricator.

(4) Oil or dust on the points impairs spark performance.

Oil on the points will considerably shorten point service life. Wipe it off from time to time.

**F. Adjusting Ignition Timing**

(1) Tools and Instruments for adjusting are follows:

- Dial gauge (accuracy-1/100 mm)
- Dial gauge adapter
- Conductivity testing lamp, YAMAHA electrotester or YAMAHA

point checker.

Point wrench

Slot-head screw driver

12-mm spanner

(2) Adjust ignition timing separately for the right and left cylinders.

(3) Rotate the armature until the points are at their widest opening. Adjust point gap with a feeler gauge to 0.30 ~ 0.40 mm (0.011 ~ 0.016 in.). Repeat this procedure for each set of points. (Fig. 6-5-13)

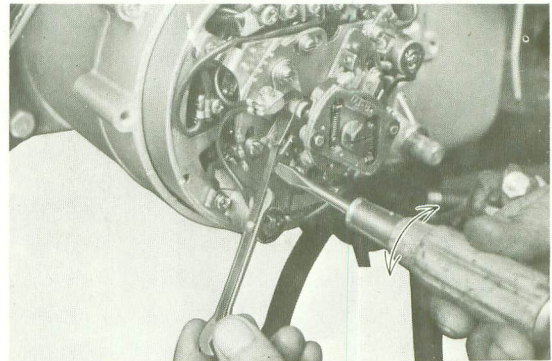

Fig. 6-5-13

(4) Screw the dial gauge adapter (B) into the spark plug hole of either cylinder head and install the gauge. Tighten the gauge set screw with finger pressure only. Turn the armature bolt counter-clockwise until the piston reaches Top Dead Center. At this point the dial gauge needle will pause. Turn the dial gauge face until the zero indicator lines up with needle. (Fig. 6-5-14)

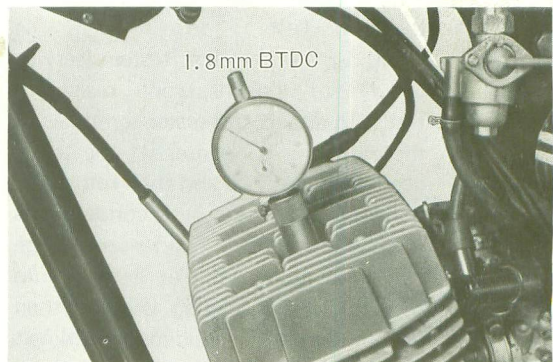

Fig. 6-5-14



- (5) Insert a match, bent spoke or other suitable material into the hole in the advance plate of the governor assembly. This will hold the governor assembly at the maximum advance position. All YAMAHA engines with electric starter utilize a governor assembly. This assembly must be at maximum advance before the engine is timed. (Fig.6-5-15)

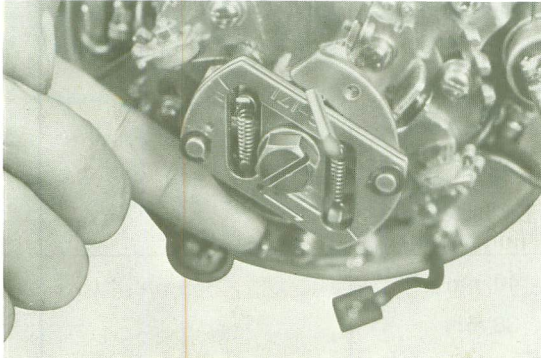

Fig. 6-5-15

- (6) Connect the electrotester (or point checker) terminals to the point assembly. Positive (+) lead to  $I_1$  or  $I_2$ , Negative (-) to a good ground. (Fig.6-5-16)

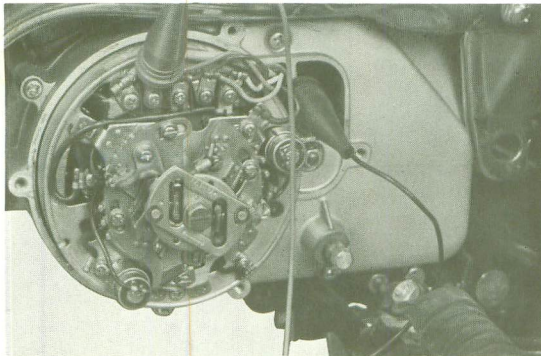

Fig. 6-5-16

- (7) From the Top Dead Center position, rotate the armature against the normal direction of rotation until the dial gauge indicates 2.5 ~ 3.0 mm travel. Then, in the normal direction of rotation, turn the crank until the dial gauge reads 1.80 mm BTDC. At this point resistance across the points should procedure on the opposite set of points and set timing balance within 0.05 mm.

(Note: In order to understand timing balance consider the following example; if the right cylinder points are opening to 6 ohm resistance at 1.81 mm BTDC, then the left cylinder points should open to 6 ohms resistance at 1.81 mm BTDC  $\pm 0.5$  mm)

- (8) Check the other cylinder in the same way.

Keep the error between the right and left sides within 0.05 mm.

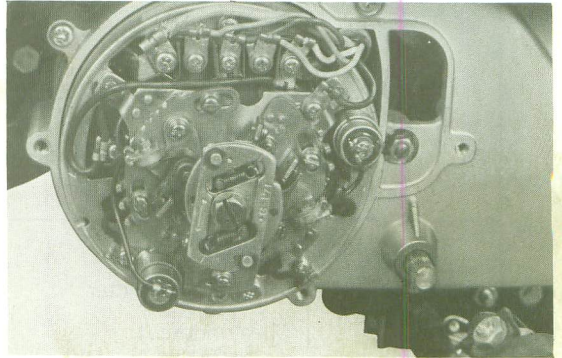

Fig. 6-5-17

## 9. Dynamo Adjustment Standards

The following data is the same as that for the CS3B.

Part	Item	Maintenance	Inspection
Field	Resistance (20°C) Shunt	4.9Ω	When voltage is irregular
	Series	0.0135Ω	
Brushes	Material	CG-6R-1	First 6,000km (4,000mi.) Every 4,000km (2,500mi.)
	Number	4	
	Width x thickness x length	8 x 4.5 x 20mm	
	Minimum length	8mm	
	Spring capacity	(360g~600g) (initial use)	
Commutator	Diameter	40 mm	
	Minimum diameter	38 mm	
	Mica undercut	0.5~0.8mm	
	Minimum mica undercut	0.2mm	
	Difference between max. and min. diameter	0.03mm	
Breaker	Point gap	0.30~ 0.40 mm	Every 3,000km (2,000mi.) (High rpm irregular) (Ignition irregular)
	Point pressure	700g	
	Ignition timing	BTDC1.8mm (21°C)	
	Automatic spark advancer	Starting 1,200 rpm Final 1,600 rpm Advance 12°	
Others	Dynamo dia. (outer)	134 mm	
	Dynamo dia. (inner)	130 mm	
	No. of poles	8	
	Core gap	0.3mm	
	Armature taper	20 x 1/10	
	Cut-in rpm	1,700 rpm	
Capacity	Rated output RPM	14-V, 7-A/1,900rpm	

## 6-6. Regulator (Voltage Regulator)

The dynamo alone can not provide stable electric current because fluctuating engine rpm affects the voltage. The regulator (also called a voltage relay) stabilizes the voltage generated by breaking the field coil circuit when the voltage exceeds a preset level.

A cutout relay (also called a charging relay) is built into the regulator. It allows stable electric current from the dynamo to charge the battery. However, when the engine stops, or when its speed is so low that the dynamo output is lower than that of the battery, it breaks the circuit to the battery so the battery will not discharge. The starting switch is provided in order to direct a flow of current to the starter dynamo when the engine is started.

### 1. Inspection and Adjustment

If the regulator can no longer control the voltage, the battery will be discharged or overcharged, and all electrical parts may be burned out, so use a good tester when inspecting or adjusting the regulator. (It is advised that you learn how to adjust the regulator at training courses because it is difficult.)

#### A. No-Load Voltage

##### (1) Inspection

- Disconnect the wire at terminal B (red) of the regulator and connect the positive tester lead to terminal B (red). Then ground the negative tester lead.
- Start the engine and keep it running at 2,500 rpm. Your regulator is correct if the tester reads 15.6 ~ 16.3 V (Fig. 6-6-1)

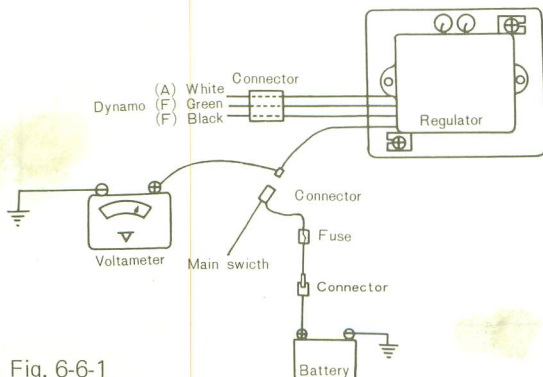

Fig. 6-6-1

#### (2) Adjustment

If the voltage is measured and found to be more or less than the specified range, adjust it by raising or lowering the spring pin on the voltage relay side.

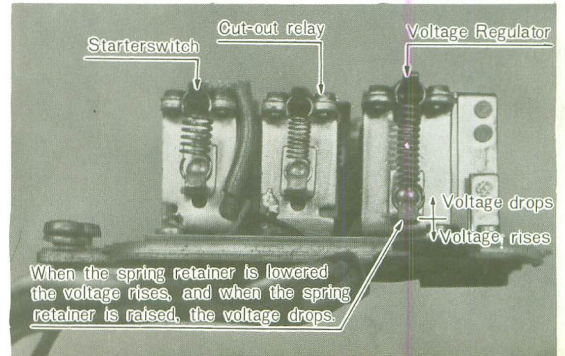

Fig. 6-6-2

#### B. Cut-in Voltage of the Cut-out Relay

##### (1) Inspection

- Disconnect the lead from the dynamo A terminal, connect the tester positive lead to the A terminal, and then ground the negative lead to the frame. (Fig. 6-6-3)
- Start the engine, and increase engine speeds slowly. The cut-out relay is correctly set if its breaker points close at 12.5 ~ 13.5 V. (approx. 1,800 rpm)

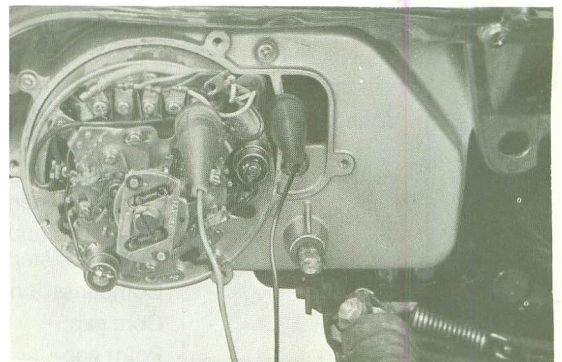

Fig. 6-6-3

(2) Adjustment

If the breaker points will not close at the specified voltage, adjust the cutout relay by changing its spring tension.

(Fig.6-6-4)

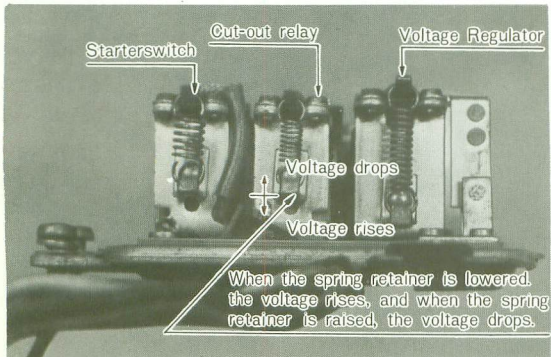

Fig. 6-6-4

In actual practice, there will rarely be need to adjust the cutout relay.

If the point surfaces of the voltage and cutout relays are worn or pitted, polish them with fine sandpaper (#400 ~ 600) before making any adjustment.

(3) Regulator Maintenance Standards.

The following data is the same as that for the CS3-B

	Item	Maintenance standards	Inspection
Voltage regulator	No load voltage adjustment value	15.6~16.3V/2,500rpm	when voltage is irregular
Voltage relay	Voltage coil resistance value	8.1Ω/20°C	
	Field coil input resistance	10Ω/20°C	
	Compensation value	16Ω/20°C	
	Core gap	1.0~1.2mm	
	Point gap	0.3~0.4mm	
Cutout relay	Cut-in voltage	13 ± 0.5V	
	Reversing current	5A or less	
	Voltage coil resistance value	79.2Ω/20°C	
	Core gap	0.3~0.5mm	
	Point gap	0.7~0.9mm	

## 6-7. Ignition Coil

The ignition coil acts as a transformer, with approximately 50 times the number of windings in the secondary coil as in the primary. If the electric current supplied to the primary coil (from the battery) is interrupted by a contact breaker, the primary coil will create a 150 ~ 300 V current by self induction. This current is boosted to 12,000 ~ 14,000 V by mutual induction in the larger number of secondary coil windings, thereby making a spark jump the plug electrodes.

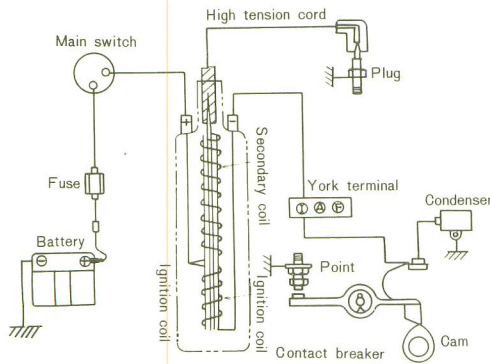

Fig. 6-7-1

### 1. Inspection

If no spark, or a rather weak spark jumps the plug gap, inspect the ignition coil as well as the contact breaker.

- (1) When you test the coil alone, use a 12 V battery as a power source.  
A spark of 7 mm or more means the coil is in good condition.

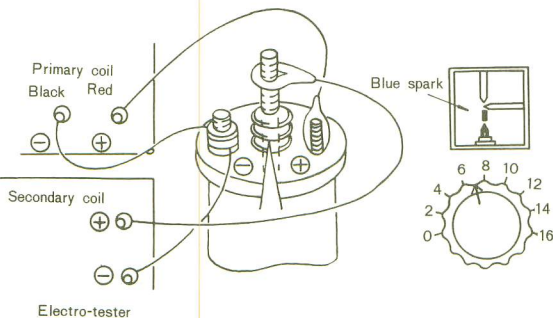

Fig. 6-7-2

### (2) Test, with Coil Installed (practical test)

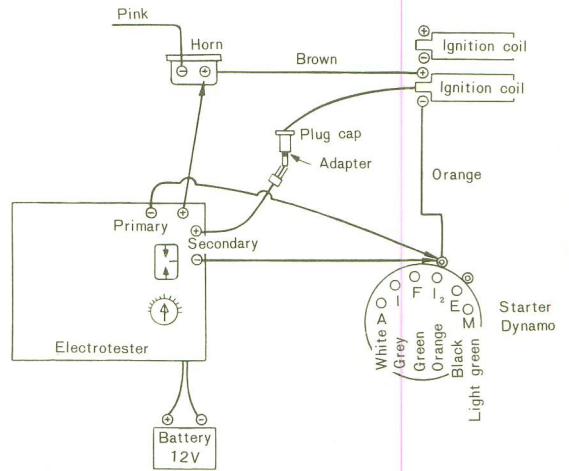

Fig. 6-7-3

- a. Disconnect the lead attached to the ignition dynamo terminal I and connect it to the negative primary and secondary leads of the tester.
- b. Detach the high tension lead from the plug, attach an adapter (copper or iron wire) to the plug lead cap, and connect this adapter lead to the positive secondary lead of the tester.
- c. Connect the positive primary lead of the tester to the brown lead terminal of the horn.
- d. Use a 12 V battery as power source for the tester.
- e. If the tester shows a spark 7 mm or more, the coil is in good condition.

## 6-8. Spark Plugs

The life of a plug end its coloring vary according to the habits of the rider. At each periodic inspection, replace burned or fouled plugs with new ones chosen according to the color and condition of the bad plugs. One machine may be ridden only in urban areas at low speeds, whereas another may be ridden for hours at high speeds, so confirm what the present plugs indicate by asking the rider how long and how fast the rides, and recommend a cold, standard, or hot type plug accordingly. It is actually economical to install new plugs every 3,000 km, since it will tend to keep the engine in good condition, thereby preventing excessive fuel consumption, etc.

## 1. How to judge Plug condition

- Best.....When the porcelain around the center electrode is a light tan color.
- If the electrodes and porcelain are black and somewhat oily, replace the plug with a hotter-type for low speed riding.
- If the porcelain is burned white and/or the electrodes are partially burned away, replace the plug with a colder-type for high speed riding.

## 2. Inspection

Instruct the rider to:

Inspect and clean the spark plug at least once a month or every 1,000 km (600 miles). Clean the electrodes of carbon and adjust the electrode gap to 0.5 ~ 0.6 mm. (.020 ~ .024 in.)

Be sure to use standard B9HC plugs as replacements to avoid any error in reach.

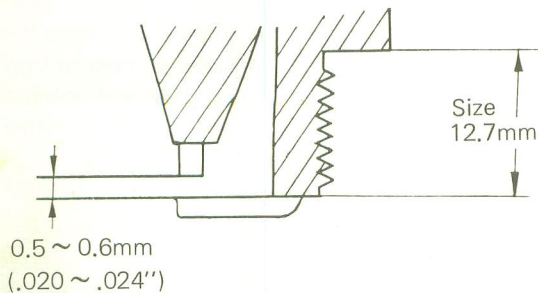

Fig. 6-8-1

## 6-9. Battery

The battery is the power source for the whole electrical system. When the engine starts, or engine speeds are low and the dynamo generates a very little amount of electricity, the battery supplies power to the ignition system, lights, etc. During riding, the dynamo supplies electric power and also recharges the battery.

### 1. Before the First Ride

A new battery should be charged by a battery service shop, but if you charge it at your shop, take the following steps.

- First, fill each battery cell to a maximum level with dilute sulphuric acid (specific gravity 1.26 ~ 1.28).

- Then charge the battery at 0.9 A for 13 hours.
- After charging, tilt up a corner of the battery to let out air bubbles. If necessary, add more acid to restore it to the maximum level, so the specific gravity is between 1.26 and 1.28. Then tighten all the cell caps.
- Wash the battery off with water to remove any sulphuric acid. Dry it and then mount it in the frame.

### 2. Periodic Inspection and Supplementary Charging

- Inspect the fluid level every month. If it drops below the middle line, instruct the rider to add distilled water to raise the fluid to the maximum level. If the battery seems to be discharged, recharge it. The secondary charge should also be at 0.9 A for 13 hours.

### 3. Maintenance

- If your motorcycle will not be used for a long time, remove the battery and have a battery shop store it. In shop equipped with a charger, do the following:
  - Recharge the battery after it is removed.
  - Store it in a cool, dry place, and avoid temperatures below 0°C. (32°F)
  - The battery should be recharged once a month and before mounting.