

250

# YAMAHA MX 400B

OWNER'S SERVICE  
MANUAL

[www.legends-yamaha-enduros.com](http://www.legends-yamaha-enduros.com)

510-28199-10

## NOTICE

Yamaha Motor Company is confident you will enjoy your new Yamaha to the utmost. We have made every effort to provide you with a safe, well-engineered and constructed product.

This Owner's Service Manual will acquaint you with several features and maintenance procedures concerning your Yamaha. However, if you are unfamiliar with the product, or the features or procedures outlined within this manual, we strongly urge you to consult your Authorized Yamaha Dealer for additional information.

MX400B OWNER'S SERVICE MANUAL

FIRST EDITION SEPTEMBER 1974

All Rights Reserved by Yamaha Motor Company Limited,  
Japan. Printed in Japan LIT 11625-10-00



[www.legends-yamaha-enduros.com](http://www.legends-yamaha-enduros.com)

## FOREWORD

Yamaha's MX400B is completely new model designed solely for the rigors of Motocross competition. Each unit is assembled and checked according to the same rigorous principles as our championship road racing model.

This Owner's Service Manual is included to provide basic information for operation and maintenance. Additional information regarding major repairs, such as crankcase disassembly, can be found within the DT250B/400B Service Manuals and various other information and training manuals available from your Authorized Yamaha.

YAMAHA MOTOR COMPANY., LTD.  
SERVICE DEPARTMENT  
INTERNATIONAL DIVISION  
IWATA, JAPAN



[www.legends-yamaha-enduros.com](http://www.legends-yamaha-enduros.com)

## TABLE OF CONTENTS

<p><b>CHAPTER 1. GENERAL INFORMATION</b> <span style="float: right;">Page</span></p> <p>SECTION A. MACHINE IDENTIFICATION..... 5</p> <p>SECTION B. GENERAL SPECIFICATIONS..... 6</p> <p>SECTION C. MAINTENANCE SPECIFICATIONS..... 9</p> <p>SECTION D. TORQUE CHART..... 11</p> <p>SECTION E. MAINTENANCE AND LUBRICATION SCHEDULE... 12</p> <p>SECTION F. SPECIAL TOOLS..... 17</p> <p><b>CHAPTER II. BASIC INSTRUCTIONS</b></p> <p>SECTION A. CONTROL FUNCTIONS..... 18</p> <p>SECTION B. FUEL AND OIL..... 22</p> <p><b>CHAPTER III. OPERATION</b></p> <p>SECTION A. PRE-OPERATION CHECK LIST..... 25</p> <p>SECTION B. BREAK-IN PROCEDURE..... 26</p> <p>SECTION C. STARTING AND OPERATION... 26</p> <p><b>CHAPTER IV. MECHANICAL ADJUSTMENTS</b></p> <p>SECTION A. BRAKES..... 28</p> <p>SECTION B. CLUTCH..... 29</p> <p>SECTION C. CHAIN..... 31</p> <p>SECTION D. CARBURETOR..... 32</p> <p>SECTION E. SPARK PLUG..... 35</p>	<p><b>CHAPTER IV. MECHANICAL ADJUSTMENTS</b> <span style="float: right;">Page</span></p> <p><b>(cont'd)</b></p> <p>SECTION F. IGNITION TIMING..... 36</p> <p><b>CHAPTER V. ENGINE MAINTENANCE AND MINOR REPAIRS</b></p> <p>SECTION A. AIR FILTER..... 38</p> <p>SECTION B. CARBURETOR AND REED VALVE..... 42</p> <p>SECTION C. TOP END AND MUFFLER... 54</p> <p>SECTION D. IGNITION..... 71</p> <p>SECTION E. KICK STARTER, CLUTCH, SHIFTER AND TRANSMISSION 74</p> <p>SECTION F. DRIVE SPROCKETS AND CHAIN..... 85</p> <p><b>CHAPTER VI. CHASSIS MAINTENANCE AND MINOR REPAIRS</b></p> <p>SECTION A. WHEELS, TIRES AND BRAKES.. 90</p> <p>SECTION B. FRONT FORK AND STEERING HEAD..... 96</p> <p>SECTION C. REAR SHOCK (MONOCROSS SUSPENSION) AND SWING ARM... 101</p> <p><b>CHAPTER VII. MISCELLANEOUS</b></p> <p>SECTION A. CONVERSION TABLES..... 107</p> <p>SECTION B. CLEANING AND STORAGE... 108</p> <p>SECTION C. WARRANTY..... 110</p> <p>SECTION D. MAINTENANCE RECORD..... 111</p>
---	---

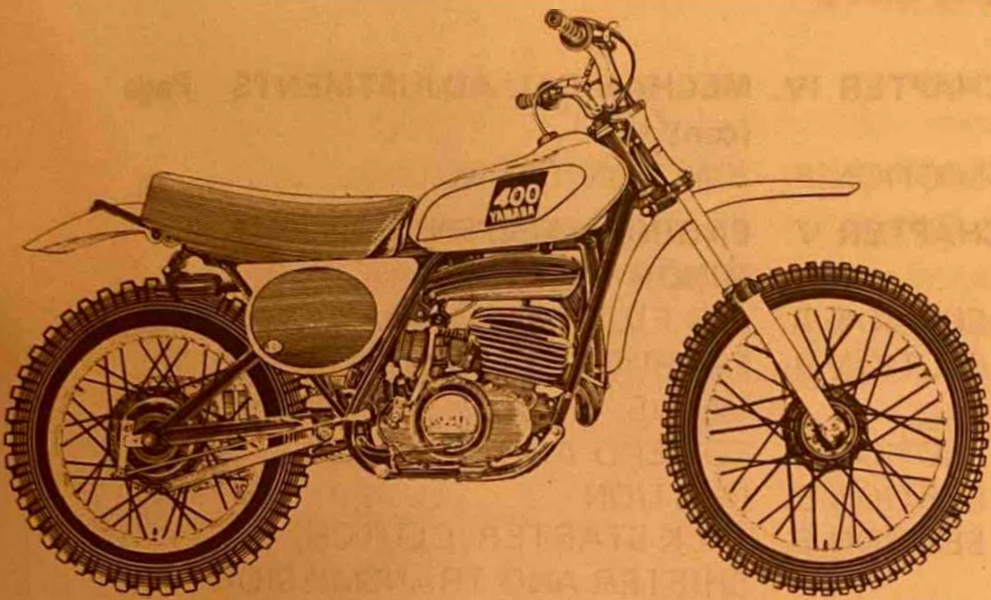

Right Side View

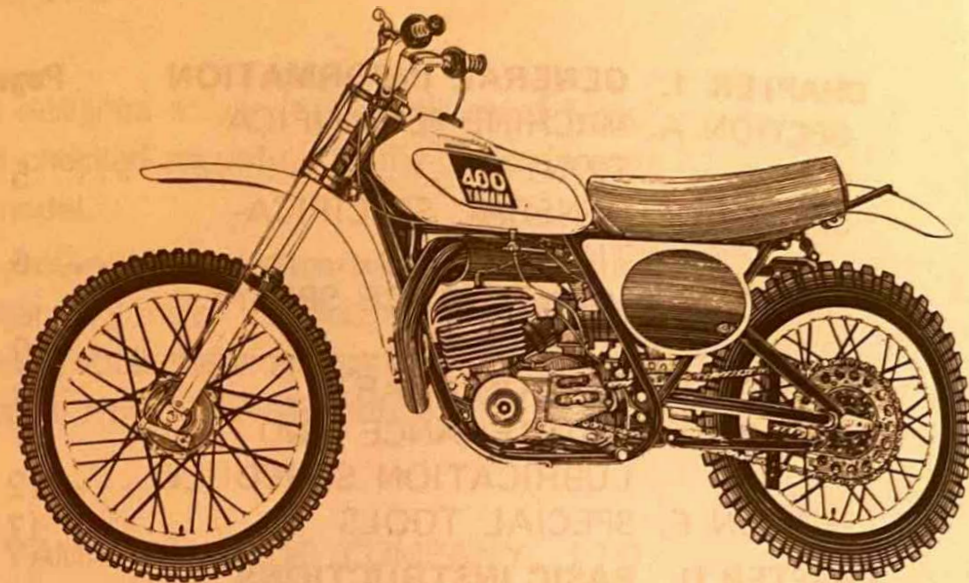

Left Side View

[www.legends-yamaha-enduros.com](http://www.legends-yamaha-enduros.com)

## CHAPTER I. GENERAL INFORMATION

### SECTION A. MACHINE IDENTIFICATION

#### 1. FRAME SERIAL NUMBER

The frame serial number is located on the right-hand side of the headstock assembly. The first three digits identify the model. This is followed by a dash. The remaining digits identify the production number of the unit. Yamaha production begins 000101.

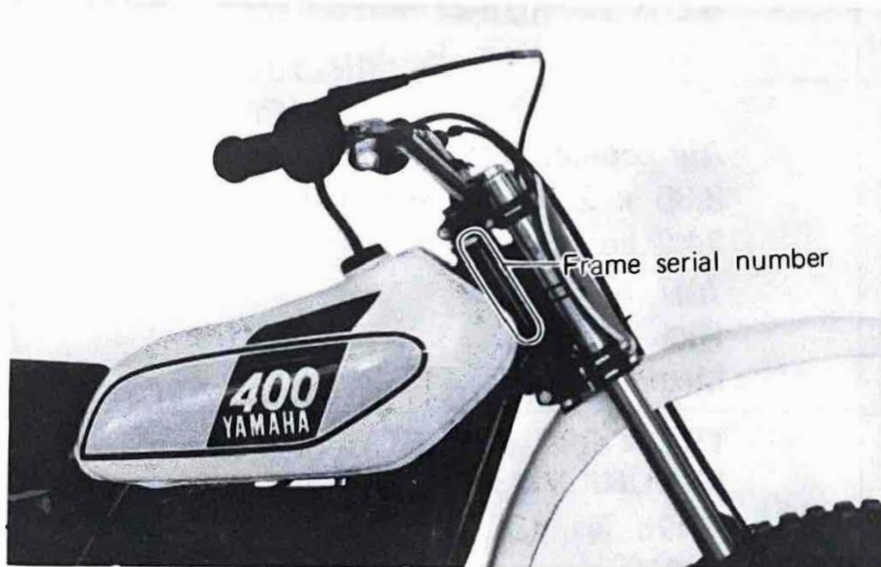

#### 2. ENGINE SERIAL NUMBER

The engine serial number is stamped into the right side of the engine on top of the crankcase. Engine identification follows the same code as frame identification.

Normally, both serial numbers are identical; however, on occasion they may be two or three numbers off.

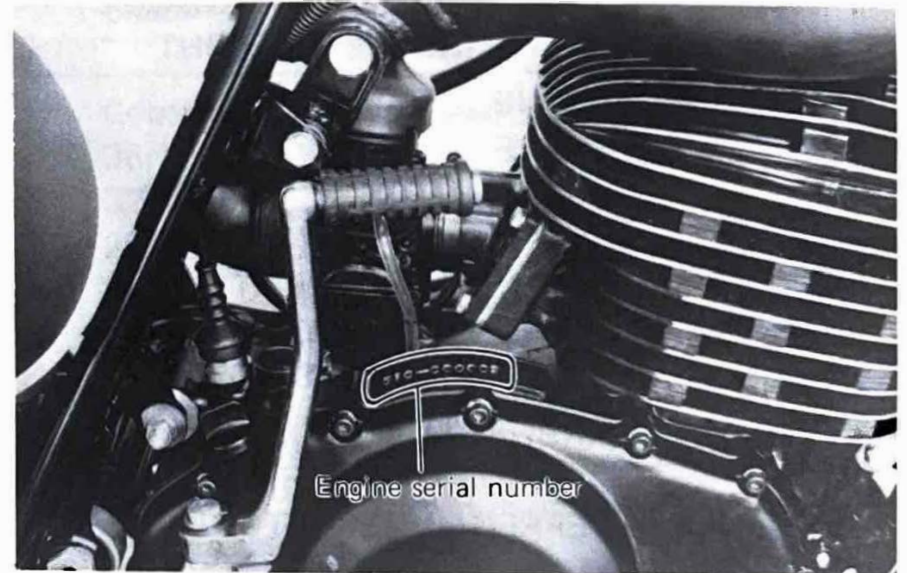

[www.legends-yamaha-enduros.com](http://www.legends-yamaha-enduros.com)

## SECTION B. GENERAL SPECIFICATIONS

These specifications are for general use. For a more complete list, refer to Maintenance Specifications and/or the Service Manuals.

<b>DIMENSIONS/WEIGHT</b> OVERALL LENGTH OVERALL WIDTH OVERALL HEIGHT WHEELBASE MINIMUM GROUND CLEARANCE SEAT HEIGHT (UNLOADED) MACHINE NET WEIGHT	83.57 ins. (2,105 mm.) 38.78 ins. ( 985 mm.) 45.87 ins. (1,165 mm.) 56.18 ins. (1,415 mm.) 9.25 ins. ( 235 mm.) 33.07 ins. ( 840 mm.) 232 lbs. (105 kgs.)
<b>ENGINE</b> TYPE BORE/STROKE DISPLACEMENT COMPRESSION RATIO STARTING SYSTEM LUBRICATING SYSTEM	Air cooled, 2-stroke, single 3.35 x 2.76 ins. (85 x 70 mm.) 24.2 cu.in. (397 c.c.) 7.57 : 1 Kick Starter Mixed Gas 20 : 1
<b>CARBURETION</b> MANUFACTURER/TYPE EFFECTIVE VENTURI SIZE MAIN JET NEEDLE JET	MIKUNI VM38SS 1.496 ins. (38 mm.) # 350 P-4

## GENERAL SPECIFICATIONS

JET NEEDLE PILOT JET AIR SCREW (TURNS OUT) CUT AWAY AIR CLEANER TYPE	6F16-2 # 60 1 3.0 Wet Foam
<b>CLUTCH</b> TYPE PRIMARY DRIVE SYSTEM PRIMARY DRIVE RATIO	Wet Multiple Disc Helical Gear 64/24          2.667
<b>TRANSMISSION</b> TYPE REDUCTION RATIO      1st 2nd 3rd 4th 5th	Constant mesh 5-speed forward 36/16          2.250 32/19          1.684 29/23          1.260 26/26          1.000 23/29          0.793
<b>SECONDARY DRIVE</b> DRIVE/DRIVEN SPROCKET TYPE/SIZE REDUCTION RATIO	14/50 Chain DK520/106L 3.571
<b>ELECTRICAL</b> IGNITION TYPE COIL	CDI Magneto Hitachi F6T40191



## GENERAL SPECIFICATIONS

<p><b>CHASSIS</b></p> <p>FRAME TYPE            FRONT SUSPENSION/TRAVEL            REAR SUSPENSION/TRAVEL            STEERING LOCK-TO-LOCK (DEGREES)            CASTER/TRAIL            FRONT TIRE MFR./SIZE            TREAD TYPE            NOMINAL PRESSURE (Front tire)            REAR TIRE MFR./SIZE            TREAD TYPE            NOMINAL PRESSURE (Rear tire)            FRONT BRAKE TYPE            ACTUATING METHOD            REAR BRAKE TYPE            ACTUATING METHOD</p>	<p>Tube-double cradle            7.618 ins. (193.5 mm.)            3.543 ins. ( 90.0 mm.)            49°            59° /5.42 ins. (139 mm.)            3.00-21-4PR            Full Knobby            13 psi            4.60-18-4PR            Full Knobby            15 psi            Drum            Cable            Drum            Link-Rod</p>
<p><b>VOLUMES/TYPE FLUID</b></p> <p>GASOLINE TANK/TYPE (RATIO)            TRANSMISSION/TYPE            FRONT FORK (EACH)/TYPE</p>	<p>8.0 lit. Premium (20 : 1)            1,000 ± 50 c.c. (SAE 10W/30)            190.5 c.c. (SAE 10W/30)</p>

NOTE: The Research and Engineering Departments of Yamaha are continually striving to further perfect all models. Improvements and modifications are therefore inevitable.

In light of this fact, the foregoing specifications are subject to change without notice to the owner. Information regarding changes is forwarded to all Authorized Yamaha Dealers as soon as available. If a discrepancy is noted, please consult your dealer.

## SECTION C. MAINTENANCE SPECIFICATIONS

<p><b>C.D.I. IGNITION</b>            SECONDARY IGNITION COIL RESISTANCE            (PRIMARY)            SECONDARY IGNITION COIL RESISTANCE            (SECONDARY)            IGNITION TIMING</p> <p>SPARK PLUG            SPARK PLUG GAP</p>	<p>1.02Ω ±10%/20°C   <u>6.0KΩ+20%/20°C</u>             0.11±0.006 in.            (2.7±0.15 mm.) B.T.D.C.            NGK B8EV            0.023 in. (0.6 mm.)</p>
<p><b>ENGINE – TOP END</b>            PISTON CLEARANCE            PISTON WEAR LIMIT            RING END GAP (FREE)            RING END GAP (INSTALLED)            CONNECTING ROD AXIAL PLAY            CONNECTING ROD/CRANK SIDE            CLEARANCE</p>	<p>0.0020 - 0.0024 in. (0.055 - 0.060 mm.)            0.004 in. (0.1 mm.)            0.394 in. (10 mm.)            0.016 - 0.020 in. (0.4 - 0.5 mm.)            0.031 - 0.079 in. (0.8 - 2 mm.)             0.016 - 0.020 in. (0.4 - 0.5 mm.)</p>
<p><b>ENGINE – CLUTCH</b>            FRICTION PLATE THICKNESS            CLUTCH PLATE WARP ALLOWANCE            CLUTCH SPRING FREE LENGTH</p>	<p>0.118 in. (3 mm.)            0.002 in. (0.05 mm.)            1.626 in. (41.3 mm.)</p>



## MAINTENANCE SPECIFICATIONS

<p><b>CHASSIS</b></p> <p>FRONT BRAKE SHOE DIAMETER</p> <p>FRONT BRAKE SHOE REPLACEMENT LIMIT</p> <p>REAR BRAKE SHOE DIAMETER</p> <p>REAR BRAKE SHOE REPLACEMENT LIMIT</p> <p>WHEEL RUN-OUT LIMITS VERTICAL</p> <p>WHEEL RUN-OUT LIMITS LATERAL</p> <p>FRONT FORK SPRING FREE LENGTH</p> <p>REAR SHOCK SPRING FREE LENGTH</p>	<p>5.118 ins. (130 mm.)</p> <p>0.079 in. (2 mm.)</p> <p>6.299 ins. (160 mm.)</p> <p>0.079 in. (2 mm.)</p> <p>0.079 in. (2 mm.)</p> <p>0.079 in. (2 mm.)</p> <p>18.465 ins. (469 mm.)</p> <p>8.229 ins. (209 mm.)</p>
<p><b>TORQUE VALUES</b></p> <p>(Also see Torque Chart - page 11.)</p> <p>CYLINDER HEAD NUT (13 mm.)</p> <p>CYLINDER HEAD NUT (17 mm.)</p> <p>FORK TUBE PINCH BOLT</p> <p>STEM PINCH BOLT</p> <p>STEM BOLT</p> <p>REAR AXLE SECURING NUT</p> <p>DRIVE SPROCKET SECURING NUT</p> <p>DRIVEN SPROCKET SECURING BOLT</p> <p>SPARK PLUG</p>	<p>14.5 ft-lbs. (2 m-kgs.)</p> <p>25.3 ft-lbs. (3.5 m-kgs.)</p> <p>14.5 ft-lbs. (2 m-kgs.)</p> <p>14.5 ft-lbs. (2 m-kgs.)</p> <p>21.7 - 28.9 ft-lbs. (3.0 - 4.0 m-kgs.)</p> <p>40 - 50 ft-lbs. (5.5 - 6.9 m-kgs.)</p> <p>42 - 51 ft-lbs. (5.8 - 7.0 m-kgs.)</p> <p>14.5 ft-lbs. (2 m-kgs.)</p> <p>19.5 - 21.0 ft-lbs. (2.7 - 2.9 m-kgs.)</p>

## SECTION D. TORQUE CHART

The chart covers those stud/bolt sizes with standard I.S.O. pitch threads. Torque specifications for components with thread pitches other than standard are given within the applicable chapter.

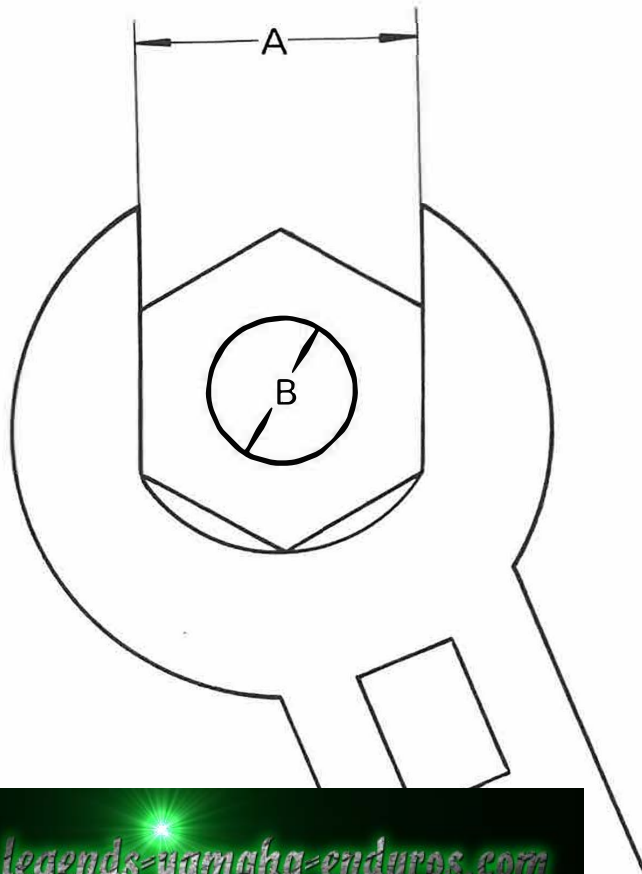

Torque specifications are for dry, clean threads. Components such as the cylinder or cylinder head should be at room temperature prior to torquing. A cylinder head or any other item with several fasteners should be torqued down in a cross-hatch pattern in successive stages until torque specification is reached. The method is similar to installing an automobile wheel and will avoid warping the component.

A (NUT)	B (BOLT)	TORQUE SPECIFICATION		
		m-kgs.	ft-lbs.	in-lbs.
10mm.	6mm.	1.0	7.2	85
13mm.	8mm.	2.0	14.5	175
14mm.	8mm.	2.0	14.5	175
17mm.	10mm.	3.5 - 4.0	25 - 29	305 - 350
19mm.	12mm.	4.0 - 4.5	29 - 33	350 - 390
22mm.	14mm.	4.5 - 5.0	33 - 36	390 - 435
26mm.	17mm.	5.8 - 7.0	42 - 51	505 - 610
27mm.	18mm.	5.8 - 7.0	42 - 51	505 - 610
30mm.	20mm.	7.0 - 8.3	51 - 60	610 - 720
SPARK PLUG		2.7 - 2.9	19 - 21	235 - 250

## SECTION E. MAINTENANCE AND LUBRICATION SCHEDULE

The maintenance and lubrication schedule chart should be considered strictly as a guide to general maintenance and lubrication intervals. You must take into consideration that weather, terrain geographical locations, and a variety of individual uses all tend to demand that each owner after this time schedule to match his environment. For example, if the motorcycle is continually operated in an area of high humidity, then all parts must be lubricated much more frequently than shown on the chart to avoid rust and damage. If you are in doubt as to how closely you can follow these time recommendations, check with the YAMAHA dealer in your area.

### MAINTENANCE AND LUBRICATION SCHEDULE CHART – NOTES

- No. (1) At ambient temperatures of 45 - 90° F, use 10W/30 "SE". Do not use "additives" in oil.
- No. (2) Use 10W/30 "SE" motor oil. (If desired, specialty type lubricants of quality manufacture may be used.)
- No. (3) Use graphite base type (specialty types available - use name-brand, quality manufacturer).
- No. (4) Light duty: smooth, light-weight, "white" grease. Heavy duty: standard 90wt. lube grease (do not use lube grease on throttle/housing).
- No. (5) Use standard 90wt. lube grease – smooth, not coarse.
- No. (6) Medium-weight wheel bearing grease of quality manufacturer – preferably waterproof.
- No. (7) Light-weight machine oil.
- No. (8) Air filters— foam element air filters must be damp with oil at all times to function properly. Clean and lube every meet. If hard usage, clean and lube every heat (MOTO). Do not over-oil. Use SAE 10W/30 "SE".
- No. (9) Use 10 ~ 30W fork oil (non-foaming hydraulic fluid).

# MAINTENANCE AND LUBRICATION SCHEDULE CHART

PAGE	ITEM	RACE/MEET INTERVAL					
		EVERY MEET	EVERY SECOND	EVERY THIRD	EVERY HEAT (MOTO)	EVERY 6 MONTHS OF RACING	AS REQUIRED
63	PISTON						
	● Inspect	X					
	● Clean	X					
	● Replace						X
66	PISTON RINGS						
	● Replace	X					
62	CYLINDER						
	● Inspect (Compression Check)	X					
	● Clean	X					
	● Replace						X
	● Check head bolt torque				X		
29	CLUTCH						
	● Adjust	X					
	● Replace (Plates)						X
84	TRANSMISSION						
	● Change Oil		X(1)				
	● Inspect gears					X	
	● Replace bearings					X	
	● Inspect shift forks					X	
69	ENGINE MAIN BEARINGS						
	● Replace					X	

(continued)

## MAINTENANCE AND LUBRICATION SCHEDULE CHART

PAGE	ITEM	RACE/MEET INTERVAL					
		EVERY MEET	EVERY SECOND	EVERY THIRD	EVERY HEAT (MOTO)	EVERY 6 MONTHS OF RACING	AS REQUIRED
67	CONNECTING ROD ● Check bearings ● Replace big end bearing ● Replace small end bearing	X				X	X
42	CARBURETOR ● Check/Adjust/Tighten ● Clean & Inspect	X X					
60	PISTON PIN ● Inspect ● Replace	X					X
61	EXHAUST SYSTEM ● Inspect	X					
71	FLYWHEEL NUT ● Torque	X					
70	KICK STARTER ● Inspect idler gear ● Replace					X	X
	FRAME ● Clean & Inspect	X					
106	SWING ARM ● Check ● Lubricate	X					
				X(5)			

(continued)



## MAINTENANCE AND LUBRICATION SCHEDULE CHART

PAGE	ITEM	RACE/MEET INTERVAL					
		EVERY MEET	EVERY SECOND	EVERY THIRD	EVERY HEAT (MOTO)	EVERY 6 MONTHS OF RACING	AS REQUIRED
28	CONTROLS & CABLES ● Check & Adjust ● Lubricate	X X(3)					
28	BRAKES ● Clean/Check/Adjust ● Replace	X					X
90	WHEELS AND TIRES ● Check pressure ● Check runout ● Check spoke tension ● Check bearings ● Replace bearing	X X X X			X		X
96	STEERING HEAD ● Check ● Clean and repack	X		X(6)			
73	CDI WIRING ● Check connections	X					
38	AIR FILTER ● Clean and oil ● Replace	X(8)					X

(continued)



## MAINTENANCE AND LUBRICATION SCHEDULE CHART

PAGE	ITEM	RACE/MEET INTERVAL					
		EVERY MEET	EVERY SECOND	EVERY THIRD	EVERY HEAT (MOTO)	EVERY 6 MONTHS OF RACING	AS REQUIRED
35	SPARK PLUG ● Replace				X		
87	DRIVE CHAIN ● Clean & lubricate ● Check tension and alignment ● Replace				X(2) X		X
11	FITTINGS AND FASTENERS ● Tighten	X					
101	FUEL TANK ● Clean/Flush ● Clean petcock filter	X X					
96	SHOCK ABSORBERS ● Drain & refill			X(2)			
29	FRONT FORKS ● Drain & refill ● Replace seals			X(9)			X
	CLUTCH AND BRAKE SHAFTS ● Lubricate	X(4)					

Note: When replacing the oil or gas in the shock absorber, consult your nearest Authorized Yamaha Dealer.

## SECTION F. SPECIAL TOOLS

The maintenance procedures outlined within this manual require special tools and instruments. A comprehensive list of the special tools is given below.

- \* 1. Outside Micrometer (0 - 25 mm.)
- \* 2. Outside Micrometer (25 - 50 mm.)
- \* 3. Outside Micrometer (75 - 90 mm.)
- \* 4. Dial Gauge (mm.)
- \* 5. Dial Gauge Stand
- \* 6. Cylinder Gauge (50 - 100 mm.)
- 7. Thickness Gauge
- \* 8. Flywheel Magneto Puller
- 9. Torque Wrench (100 - 150 kgs-cm.)
- \* 10. Verner Calipers (0 - 150 mm.)
- \* 11. Clutch Holding Tool
- 12. Mes Cylinder (0 - 250 c.c., 1 c.c. increments)

NOTE

Those items marked with an asterisk (\*) available from Yamaha.

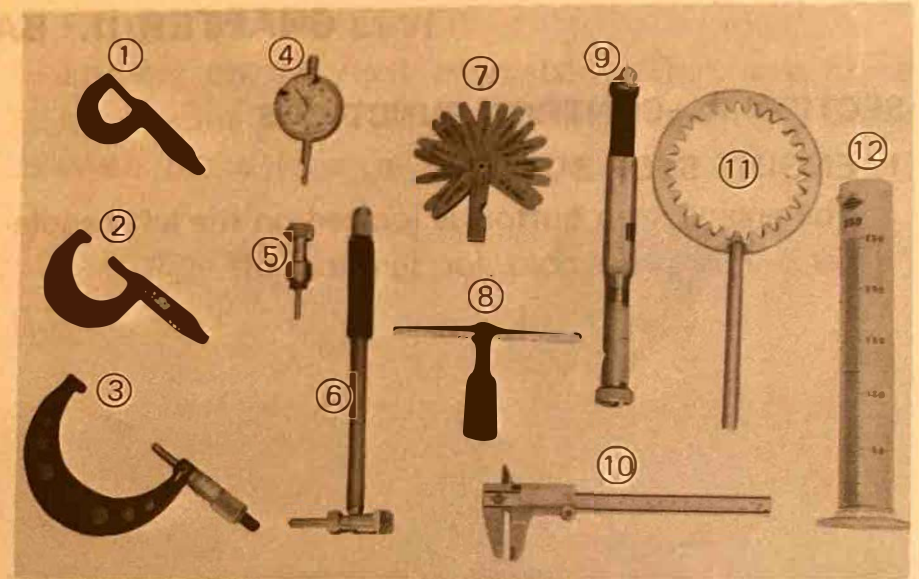

NOTE

The Research and Engineering Departments of Yamaha are continually striving to further perfect all models. Improvements and modifications are therefore inevitable.

In light of this fact, the foregoing specifications are subject to change without notice to the owner. Information regarding changes is forwarded to all Authorized Yamaha Dealers as soon as available. If a discrepancy is noted, please consult your dealer.

## CHAPTER II. BASIC INSTRUCTIONS

### SECTION A. CONTROL FUNCTIONS

#### 1. ENGINE STOP BUTTON

The engine stop button is located on the left handlebar. Push and hold for ignition off.

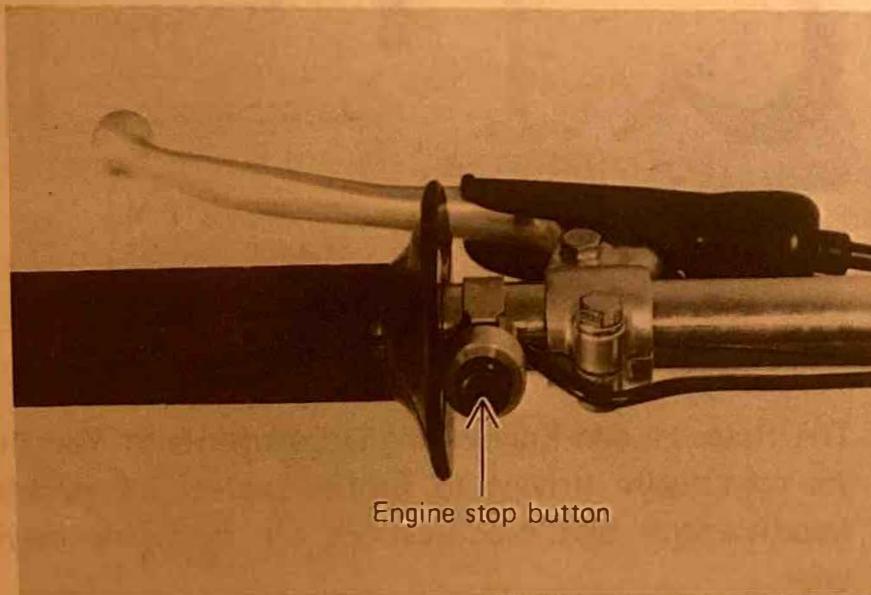

#### 2. FUEL TANK AND PETCOCK

The fuel tank incorporates a threaded plastic filler cap. The cap has a vent tube which is routed to the front of the tank and down alongside a frame down tube.

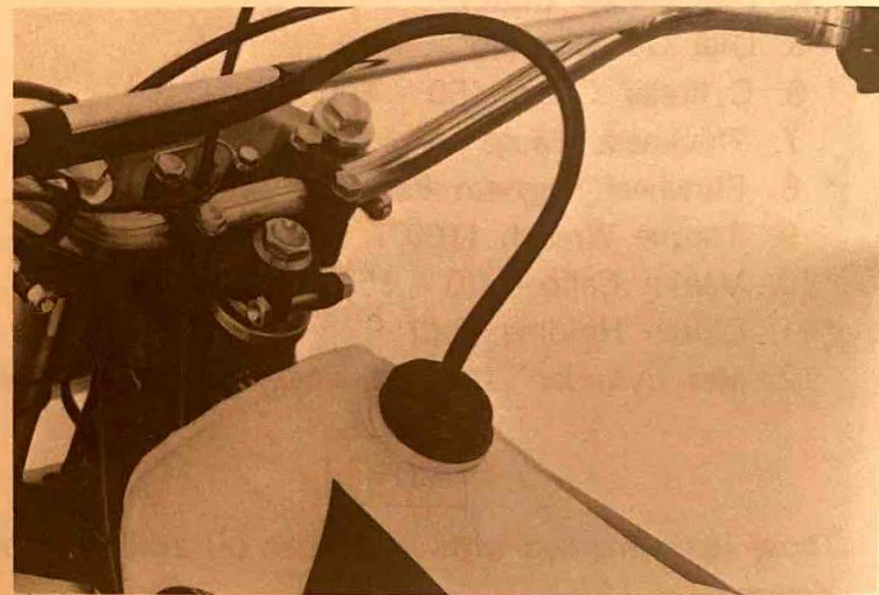

The fuel tank petcock is located on the rear left-side of the fuel tank. Turn the petcock lever to the vertical position and fuel will flow to the carburetor. Turn lever to the horizontal position to shut off fuel supply to the carburetor.

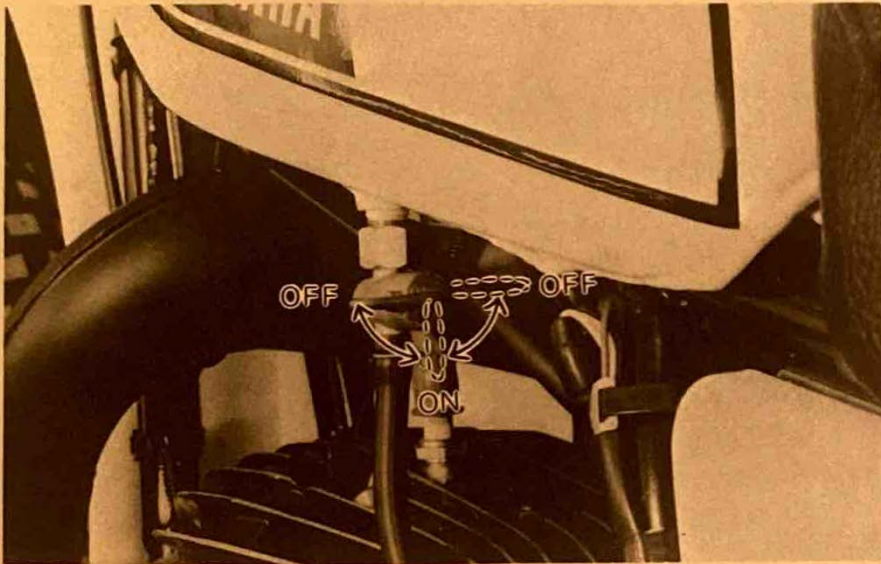

### 3. FRONT BRAKE LEVER

Located on the right handlebar. The front brake lever actuates the single leading-shoe front brake when brake lever is squeezed.



#### 4. REAR BRAKE PEDAL

Located directly in front of the right-hand rider's foot rest. The rear brake pedal actuates the single leading-shoe rear brake when the pedal is depressed.

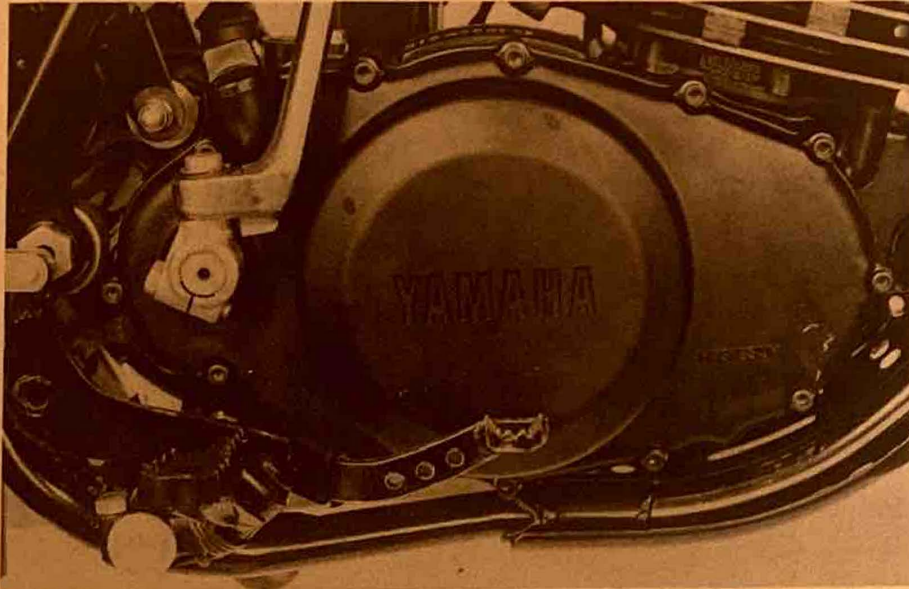

#### 5. CLUTCH LEVER

Located on the left handlebar. The clutch lever will disengage the wet-type, multi-plate clutch when the lever is squeezed.



## 6. THROTTLE

The throttle is the positive-return type, and is located on the right handlebar.

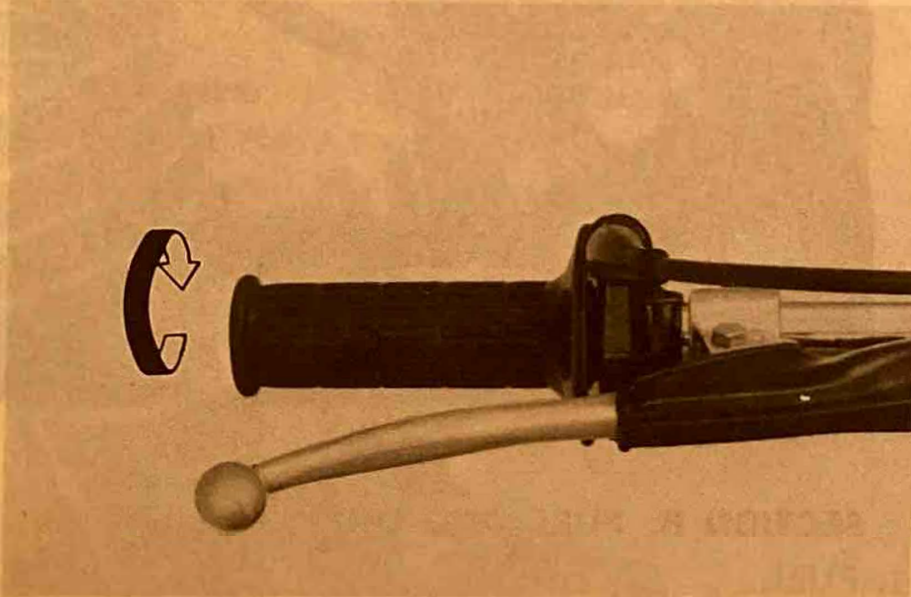

## 7. KICK CRANK

The kick starter crank is located on the right, rear side of the engine. Rotate the crank out, press your foot upon it firmly, push down until the gears engage the primary drive train and kick briskly to start the engine. Fold the crank in after engine starts.

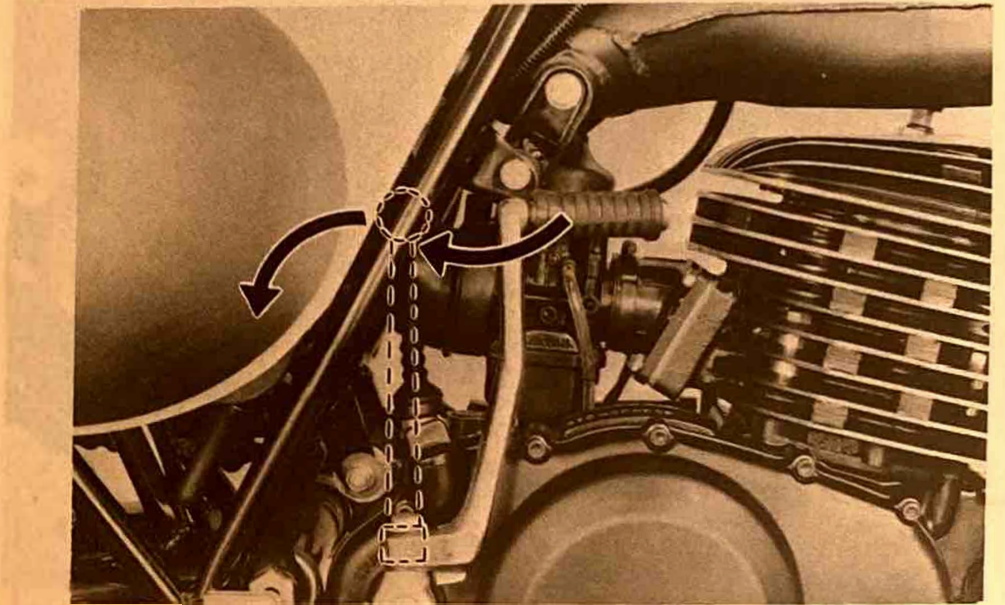

## 8. SHIFT LEVER

The transmission shift lever is located on the left-hand side of the machine directly in front of the rider's foot rest. The shift mechanism is of the ratcheting type and controls gear selection for the 5-speed transmission.

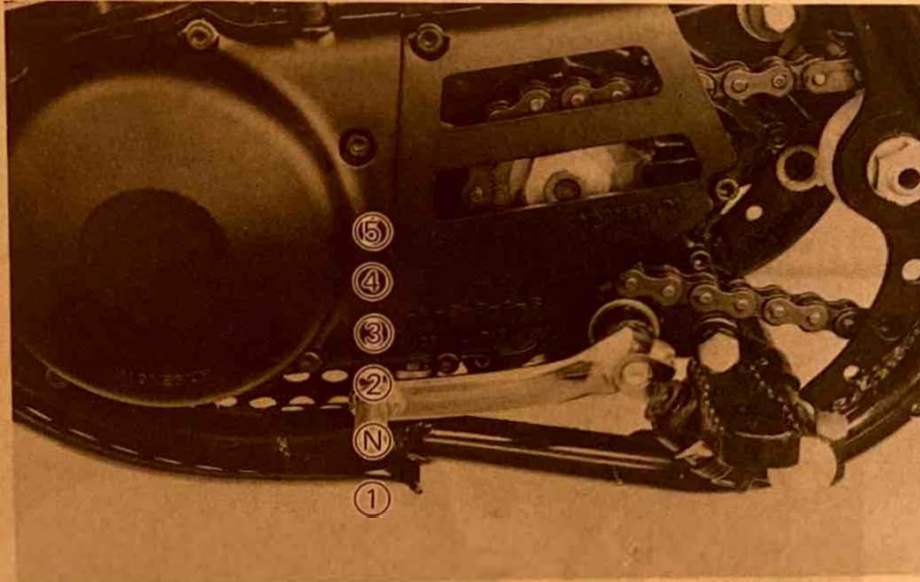

## 9. CARBURETOR STARTER JET (CHOKE)

The carburetor starter jet is located on the right side of the carburetor assembly. The jet is designed to supply an extra-rich fuel/air mixture for cold en-

gine starts. It is actuated by a knurled shaft. Pull up and rotate to open the jet.

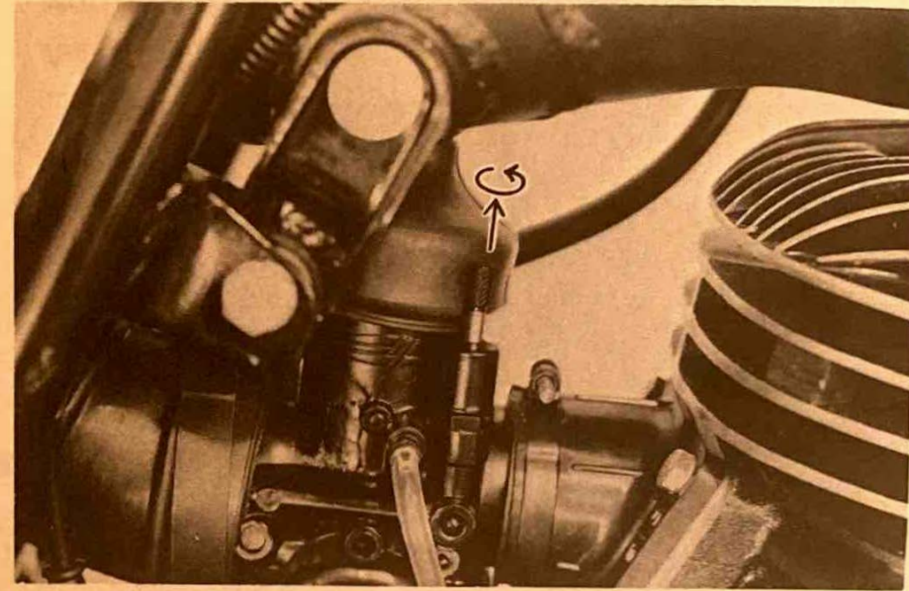

## SECTION B. FUEL AND OIL

### 1. FUEL

Use premium gasoline with an octane rating of 90+ mixed with oil at a gas/oil ratio of 20:1. Always use fresh, name-brand gasoline.

Always mix a fresh batch of fuel the morning of the race and do not retain a mixed batch overnight.

## 2. OIL

- a. Engine Mixing Oil. We recommend that your first choice be Shell Super M or Castrol R30 (vegetable base) oil. If for any reason you should use another type, the oil should meet or exceed BIA certification "TC-W". Check the container top or label for service specification and mixing ratios.
- b. Transmission Oil. The transmission filler plug is located above the kick-starter.  
Recommended oil: 10W/30 SAE type "SE" name-brand motor oil.

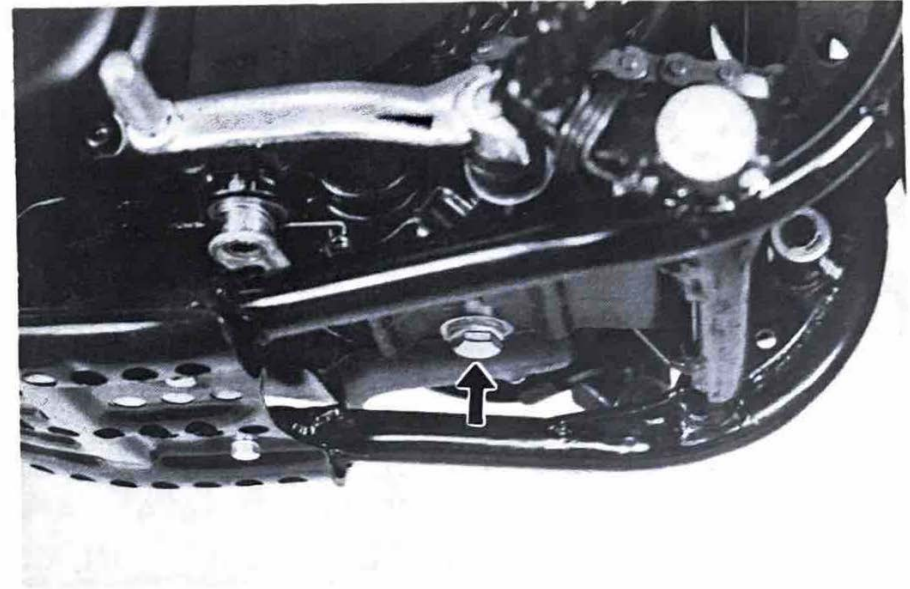

On the bottom of the engine there is a drain plug. Remove it and drain all the oil from the transmission. Reinstall the drain plug (make sure it is tight). Add oil through filler hole.

TRANSMISSION OIL CAPACITY:

1.0 - 1.1 U.S.qt. (950 - 1,050 c.c.)

The transmission should be drained and refilled every second race meet.

NOTE

Do not add any chemical additives. Transmission oil also lubricates the clutch and additives could cause the clutch to slip.



## CHAPTER III. OPERATION

### —CAUTION—

1. BEFORE RIDING THIS MOTORCYCLE, BECOME THOROUGHLY FAMILIAR WITH ALL OPERATING CONTROLS AND THEIR FUNCTION. CONSULT YOUR YAMAHA DEALER REGARDING ANY CONTROL OR FUNCTION YOU DO NOT THOROUGHLY UNDERSTAND.
2. THIS MODEL IS DESIGNED FOR COMPETITION USE ONLY. IT IS NOT EQUIPPED WITH HIGHWAY APPROVED LIGHTING, MIRRORS, HORN OR DIRECTIONAL SIGNALS. IN MOST INSTANCES, IT IS ILLEGAL TO RIDE THIS MODEL (EITHER DAY OR NIGHT) ON ANY PUBLIC STREET OR HIGHWAY.
3. OBSERVE THE BREAK-IN PROCEDURES TO PRECLUDE MECHANICAL FAILURES.

## SECTION A. PRE-OPERATION CHECK LIST

<u>ITEM</u>	<u>ROUTINE</u>
BRAKES	Check operation/adjustment
CLUTCH	Check operation/lever adjustment
FUEL TANK	Fill with proper fuel/oil mix
TRANSMISSION	Change oil as required
DRIVE CHAIN	Check alignment/adjustment/lubrication
SPARK PLUG	Replace each race (moto)
THROTTLE	Check for proper cable operation
AIR FILTER	Foam type - must be clean and damp with oil always
WHEELS & TIRES	Check pressure/runout/spoke tightness/axle nuts
FITTINGS/FASTENERS	Check all/tighten as necessary

### NOTE

Pre-operation checks should be made each time the machine is used. Such an inspection can be thoroughly accomplished in a very short time and the added safety it assures is more than worth the time involved.

## **SECTION B. BREAK-IN PROCEDURE**

1. Prior to starting, fill tank with a break-in gasoline/oil mixture of 12:1 to 14:1.
2. After fueling and pre-operational checks have been made, refer to Starting and Operation (Section C) and start engine.
3. Allow engine to warm up. Check engine idle speed. Check operating controls and engine stop button operation.
4. Operate machine in lower gears at moderate throttle settings for 3 - 5 minutes. Check spark plug condition.
5. Allow engine to cool. Repeat procedure, running for 5 minutes. Very briefly, shift to higher gears (4th or 5th) and check full throttle response. Check spark plug condition.
6. Allow engine to cool. Repeat procedure, running for 5 minutes. Full throttle and higher gears may be used, but avoid sustained full throttle operation. Check spark plug condition.
7. Allow engine to cool. Remove top end and inspect. Remove "high" spots on piston with No. 600 grit, wet sandpaper. Clean, and carefully reassemble.

8. Remove break-in fuel/oil mixture from tank. Refill with 20:1 operating fuel/oil mixture. Check entire unit for loose or mis-adjusted fittings/controls/fasteners.
9. Re-start engine and check through entire operating range thoroughly. Stop. Check spark plug condition. Re-start. After 10 - 15 minutes operation, machine is ready to race.

## **SECTION C. STARTING AND OPERATION**

### **—CAUTION—**

PRIOR TO OPERATING THE MACHINE, PERFORM STEPS LISTED IN PRE-OPERATION CHECK LIST.

### **NOTE**

Observe break-in procedures for initial operation. Agitate machine prior to starting and fuel prior to filling to provide correct mixture. Never leave the fuel in tank for long periods. The fuel/oil mix will de-nature. Turn fuel petcock lever to open (vertical) position.

## 1. STARTING COLD

Lift and rotate the starter (choke) shaft model. Keep the throttle completely closed. Engage the kick starter and start the engine.

The kick mechanism is of the primary type. Therefore, the engine may be started in any gear, provided the clutch is disengaged. The engine may be started in neutral with clutch engaged or disengaged.

## 2. STARTING WITH ENGINE WARM

Do not engage starter jet (choke). Open throttle slightly. Engage the kick starter and start the engine.

## 3. WARM-UP

Run the engine at idle or slightly higher using the starter jet (choke) as required until the engine is warm. This procedure normally takes 1 to 2 minutes. To check, see if the engine responds normally to throttle with starter jet (choke) off.

### —CAUTION—

DO NOT OPERATE ENGINE FOR EXTENDED WARM-UP PERIODS.

## 4. SHIFTING

A 5-speed transmission is used. Low gear is at the bottom of the shift pattern; high gear at the top of the shift pattern; neutral is located halfway between first and second positions.

The shift mechanism is of the ratcheting type common to most motorcycles. Allow the lever to return to its "at rest" position prior to selecting another gear. Neutral is selected by pulling up or depressing on the shift lever halfway between first and second gears.

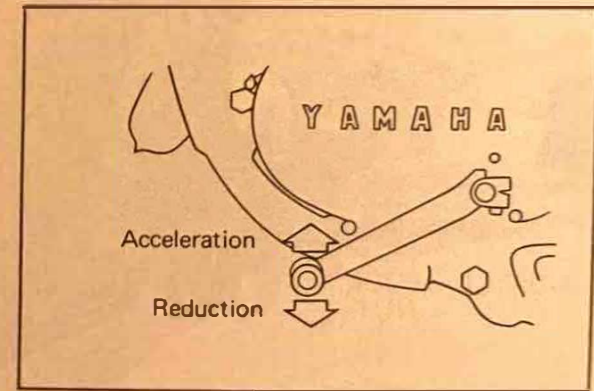

With the engine running in the neutral position, disengage the clutch (pull in clutch lever), press down on the shift lever until low gear is engaged, remove foot from shift lever, increase engine speed slightly slowly release clutch lever while advancing throttle. Repeat procedure for remaining gears.

## CHAPTER IV. MECHANICAL ADJUSTMENTS

### SECTION A. BRAKES

#### 1. FRONT BRAKE

Front brake should be adjusted to suit rider preference with a minimum cable slack of 0.2 - 0.3 in. (5 - 8 mm.) play at the brake lever pivot point.

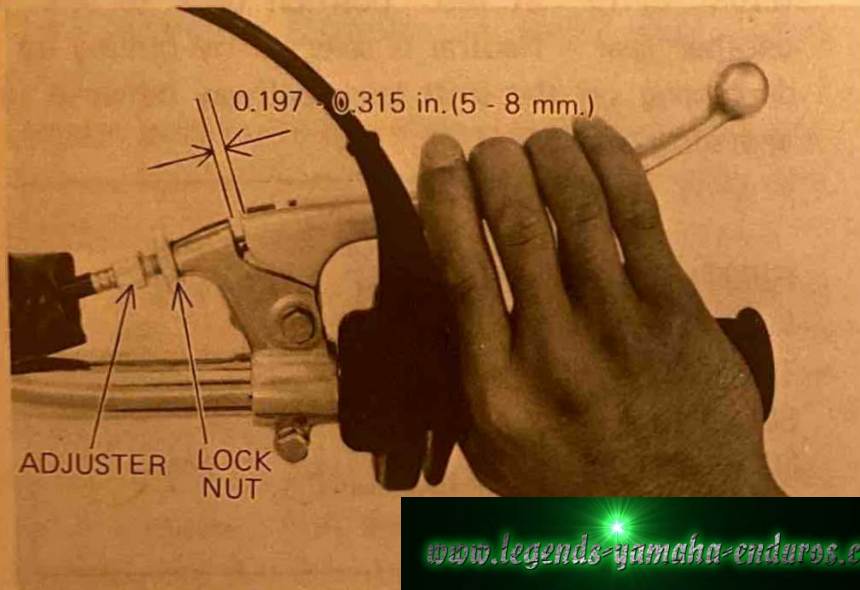

[www.legends-yamaha-enduros.com](http://www.legends-yamaha-enduros.com)

Adjustment is accomplished at one of two places; either the handle lever holder or the front brake hub.

- a. Loosen the adjuster locknut.
- b. Turn the cable length adjuster in or out until adjustment is suitable.
- c. Tighten the adjuster locknut.

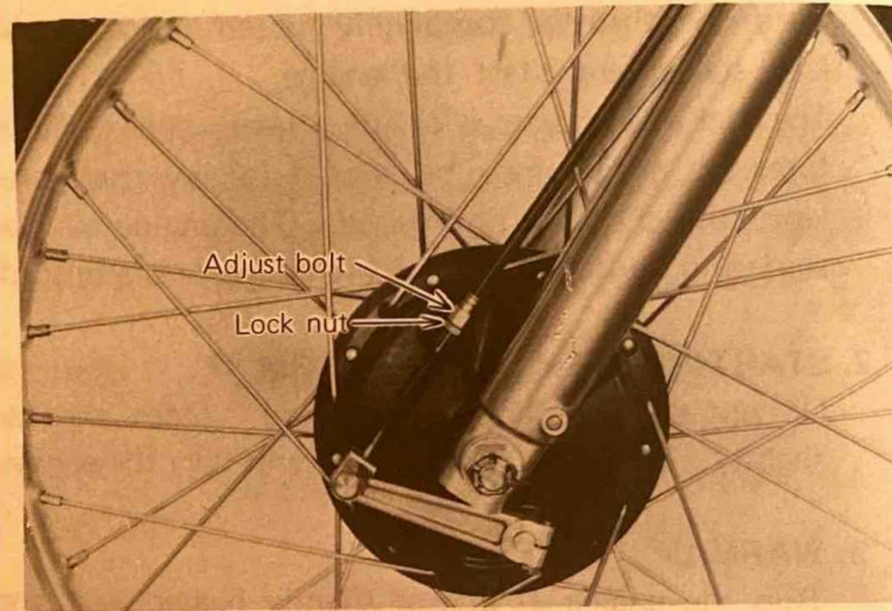

#### 2. REAR BRAKE

Adjust rear brake pedal play to suit, providing a minimum of 0.79 - 1.18 ins. (20 - 30 mm.) freeplay. Turn the adjusting nut on the rear brake ferrule in or out until brake pedal freeplay is suitable.

## NOTE

Rear brake pedal adjustment must be checked anytime chain is adjusted or rear wheel is removed and then reinstalled.

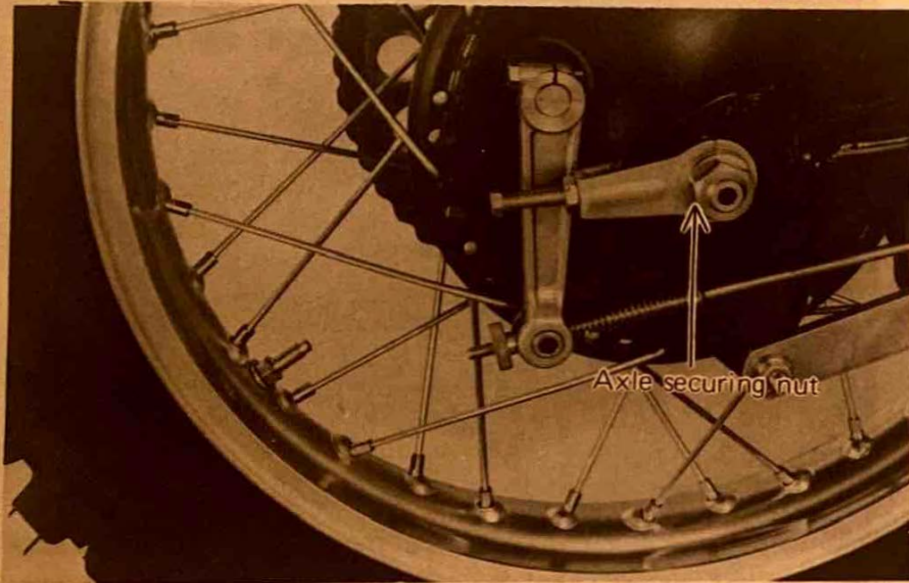

## SECTION B. CLUTCH

This model has two clutch cable length adjusters and a clutch mechanism adjuster. Cable length adjusters are used to take up slack from cable stretch and to provide sufficient freeplay for proper clutch operation under various operating conditions. The clutch mechanism adjuster is used to provide the correct amount of clutch "throw" for proper disengagement. Normally, once the mechanism is properly adjusted, the only

adjustment required is maintenance of freeplay at the clutch handle lever.

### 1. FREEPLAY ADJUSTMENT

- Loosen either the handle lever adjuster locknut or the cable inline length adjuster locknut.
- Turn the length adjuster either in or out until proper lever freeplay is achieved.

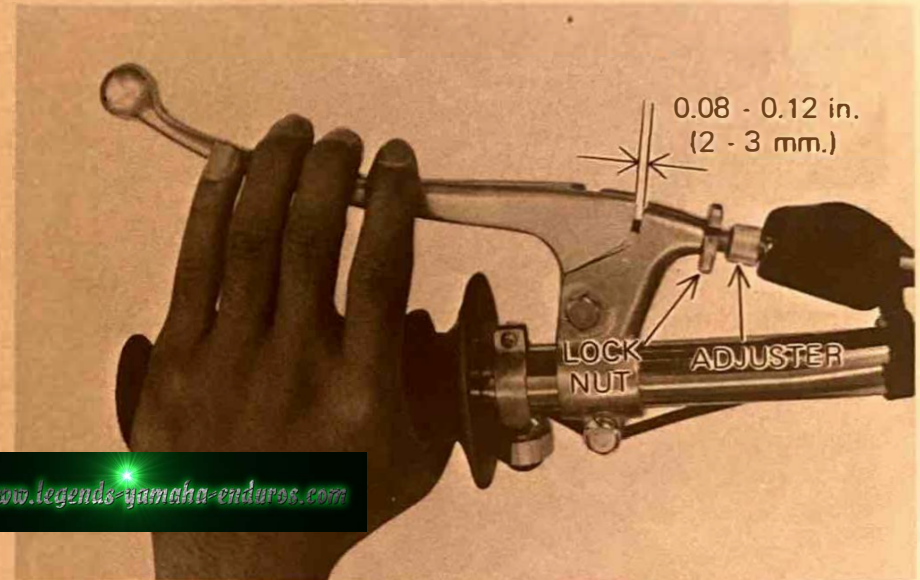

### 2. MECHANISM ADJUSTMENT

- Remove rear, left-hand crankcase cover. Note position of clutch axle lever under engine.
- Loosen adjusting screw lock nut and fully tighten eccentric adjusting screw.
- Turn either cable length adjuster in or out until lever is positioned slightly behind main axle center line.

- d. Back eccentric adjust screw out until axle lever shaft contacts clutch push rod inside engine. Turn adjust screw in approximately 1/8 turn and tighten lock nut. Readjust handle lever freeplay as required.

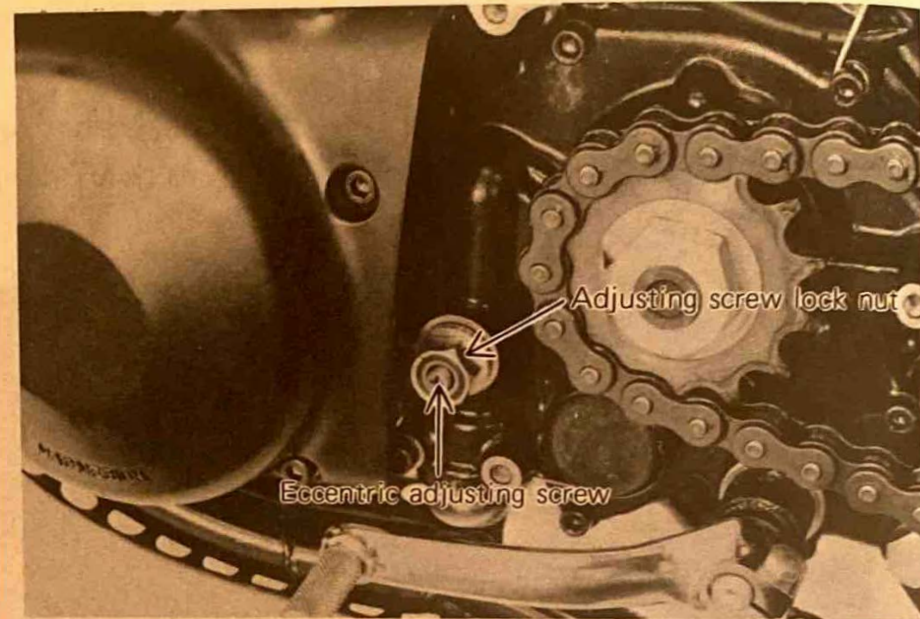
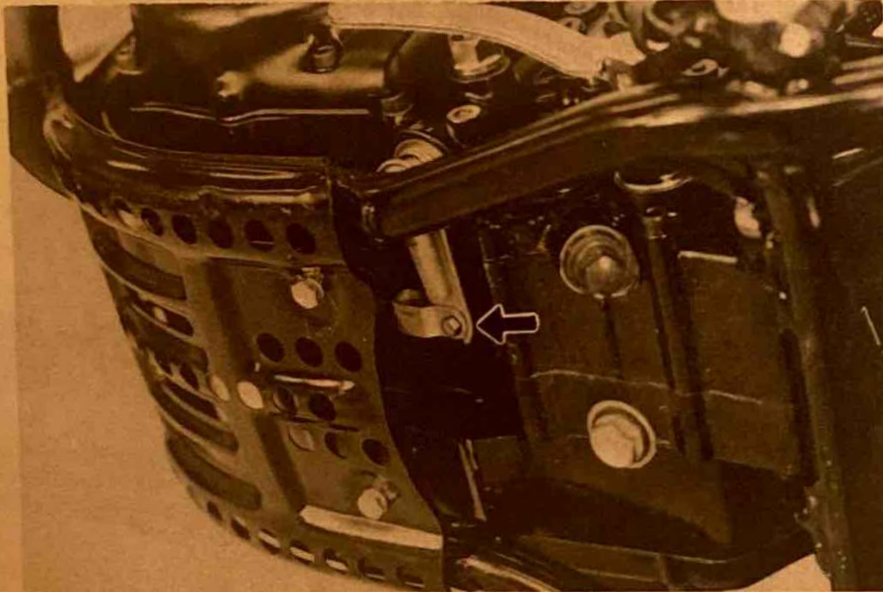

**NOTE**

After adjusting, pull clutch lever in and hold against handle grip. Measure distance from outer cable stopper (bottom of crankcase) to center of brake lever clevis pin. If distance is less than specified, loosen cable length adjuster slightly to achieve minimum distance.

**MINIMUM DISTANCE: 0.217 in. (5.5 mm.)**

## SECTION C. CHAIN

To adjust drive chain, proceed as follows:

1. Loosen axle securing nut while holding the opposite side with a screwdriver.

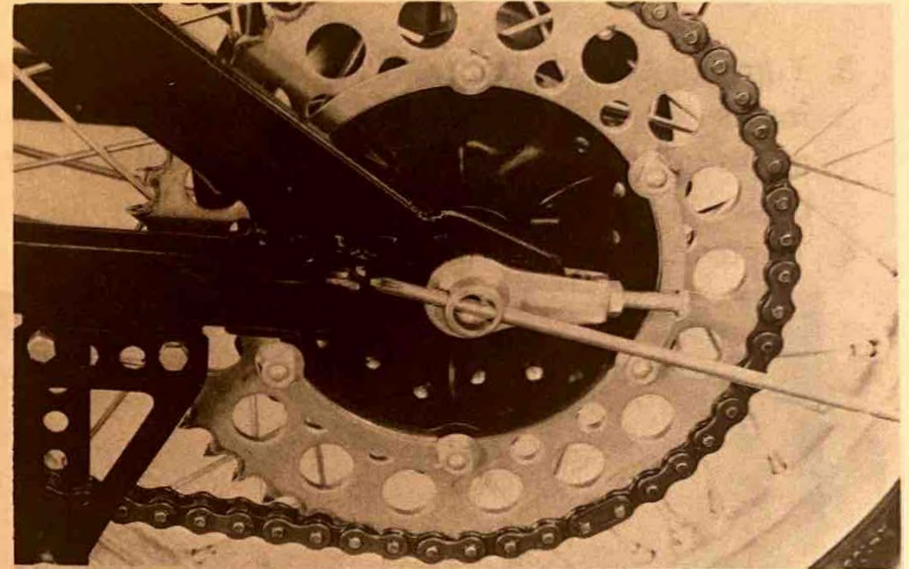
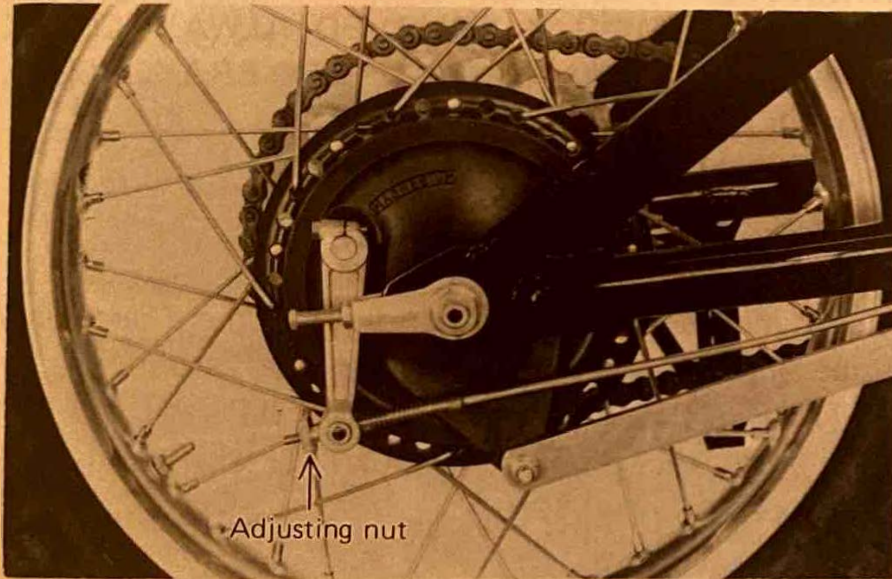

2. With rider in position on machine, both wheels on ground, set axle adjusters until there is 0.79 - 0.98 in. (20 - 25 mm.) slack in the drive chain at the bottom of the chain at a point midway between the drive and driven axles.

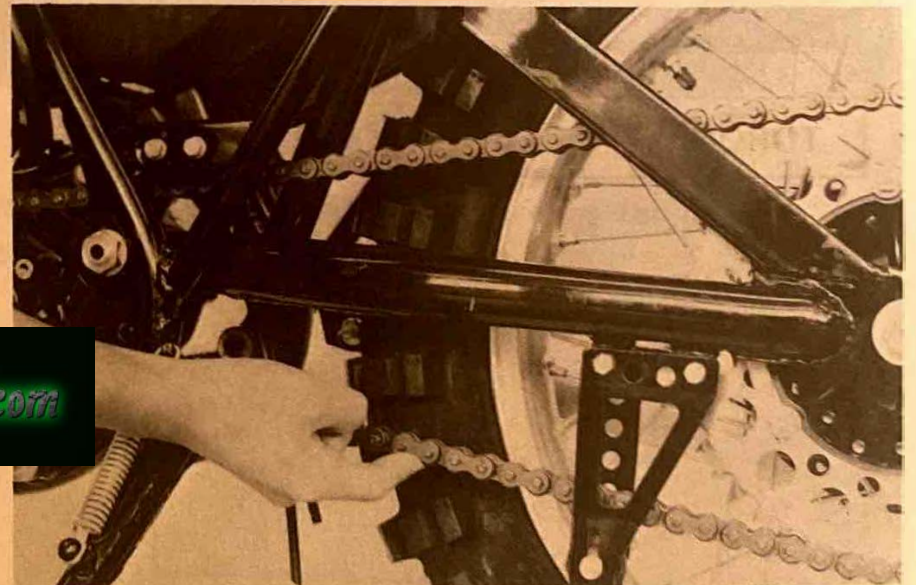

[www.legends-yamaha-enduros.com](http://www.legends-yamaha-enduros.com)



3. Turn adjust bolts both left and right until the adjust marks on the adjusters are aligned with the adjust marks on the swing arm. Tighten locknuts on adjust bolts.
4. Tighten the rear axle securing nut.

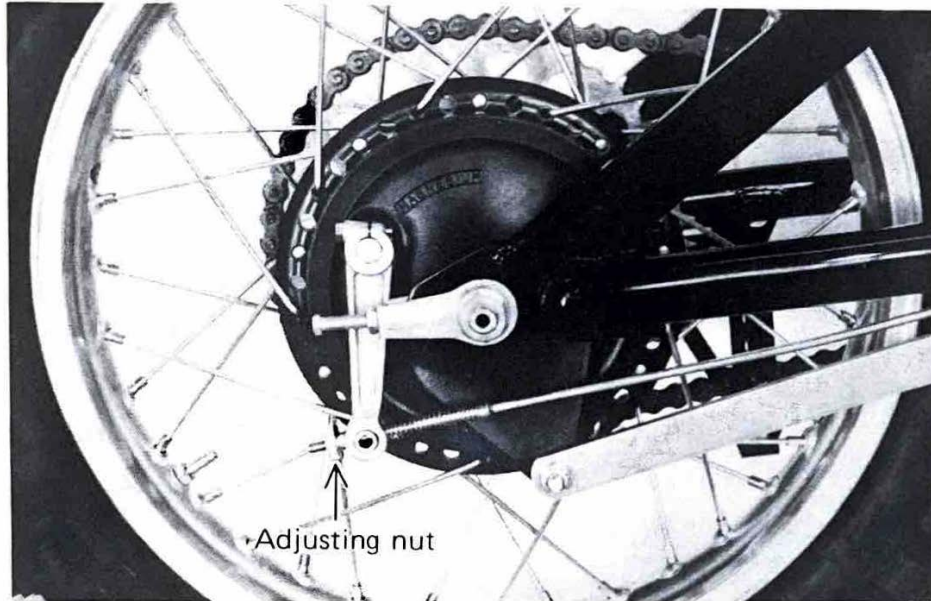

**TORQUE:** 40 - 50 ft-lbs. (5.5 - 6.9 m-kgs.)

5. Check brake pedal freeplay.

**—CAUTION—**

WHENEVER THE CHAIN IS ADJUSTED AND/OR THE REAR WHEEL IS REMOVED, ALWAYS CHECK THE REAR AXLE ALIGNMENT AND BRAKE PEDAL FREEPLAY.

**SECTION D. CARBURETOR**

Under normal operating conditions, there are only three adjustments to be made to the carburetor.

**1. THROTTLE CABLE ADJUSTMENT:**

- a. Slide the rubber cover off the top of the carburetor.



- b. Grasp the outer cable housing. Lift it up. Slack should equal 0.039 in. (1 mm.) at the adjuster. If slack is incorrect, loosen locknut and turn adjusting nut in or out as required to achieve correct slack. Tighten the locknut. Reinstall the cap cover.

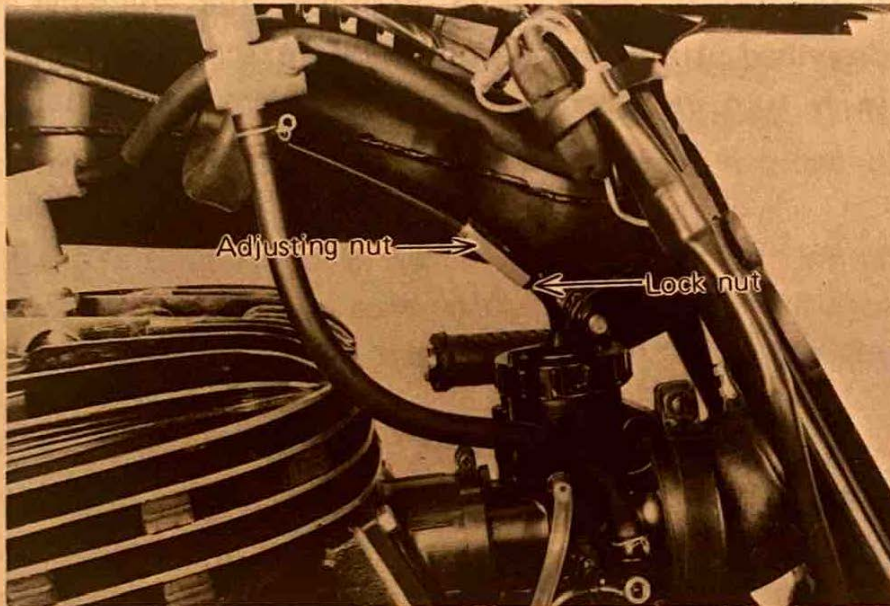

## 2. IDLE SPEED AND IDLE AIR ADJUSTMENTS:

- Turn idle air screw in until lightly seated.
- Back out 1 turns.
- Turn the idle speed adjust screw until idle is at desired rpm.

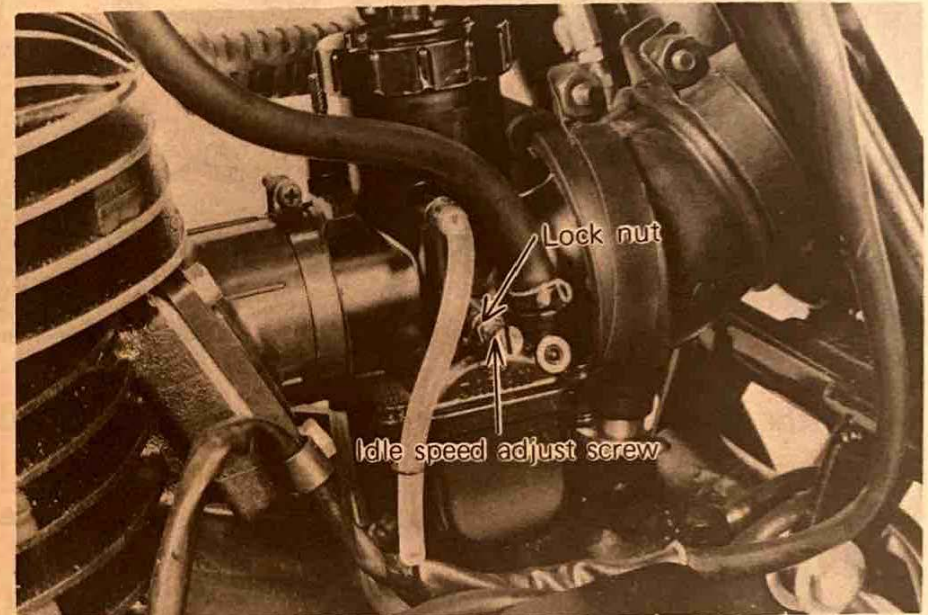

NOTE

A locknut is incorporated on the screws for positive retention.

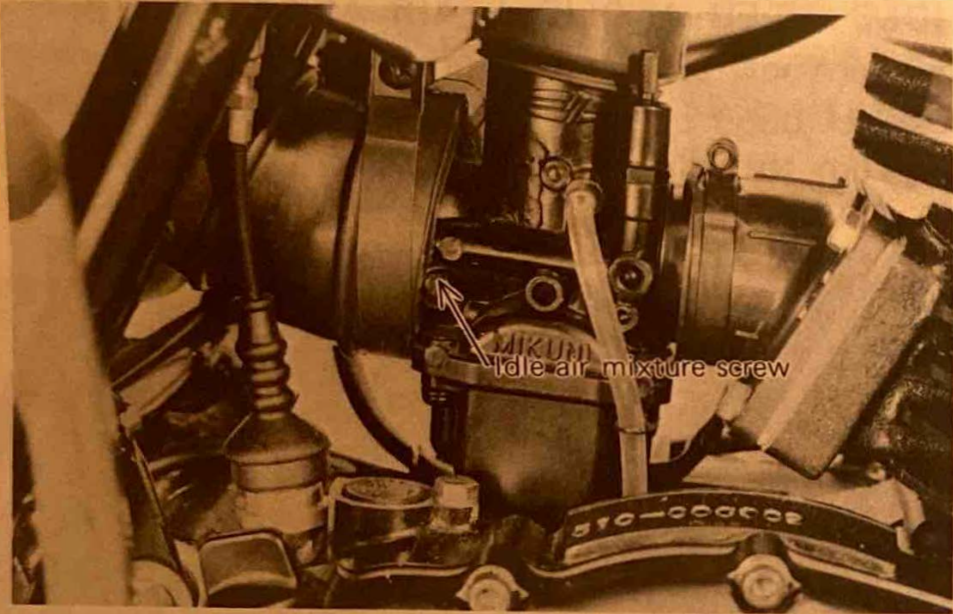

IDLE AIR SCREW: Back out 1 turns.

IDLE SPEED: As desired

If the engine, when warm, hesitates after adjusting as described, turn the idle air mixture screw in or out in  $\frac{1}{4}$  turn increments until the problem is eliminated.

Turn the idle air mixture screw in or out until speed is at highest r.p.m.

Turn the idle speed adjust screw in or out until idle speed is at desired r.p.m.

#### NOTE

Idle air mixture and idle speed adjustment screws should be so adjusted that engine response to throttle changes from idle position is rapid and without hesitation.

## SECTION E. SPARK PLUG

The spark plug in your machine indicates how the engine is operating. If the engine is operating correctly, and the machine is being ridden correctly, then the tip of the white insulator around the positive electrode of the spark plug will be a medium to light tan color. If the porcelain "donut" around the positive electrode is a very dark brown or black color, then a plug with a hotter heat range may be required. This situation is quite common during the engine break-in period.

If the insulator tip shows a very light tan or white color or is actually pure white or if the electrodes show signs of melting, then a spark plug with a colder heat range is required.

Remember, the insulator area surrounding the positive electrode of the spark plug must be a medium-to-light tan color. If it is not, check carburetion, timing, and ignition adjustments. If the situation persists, consult your Authorized Yamaha Dealer.

Do not attempt to experiment with different heat range spark plugs. This takes an experienced eye to gauge the proper spark plug heat range to use ... and to determine if the spark plug itself is at fault.

SPARK PLUG: B-8EV

SPARK PLUG GAP: 0.023 in. (0.6 mm.)

Engine conditions will cause any spark plug to slowly break down and erode. If erosion begins to increase, or if the electrodes finally become too worn, or if for any reason you believe the spark plug is not functioning correctly, replace it.

When installing the plug, always clean the gasket surface, use a new gasket, wipe off any grime that might be present on the surface of the spark plug, torque the spark plug properly.

SPARK PLUG TORQUE:

19.5 - 21.0 ft-lbs. (2.7 - 2.9 m-kgs.)

The spark plug must be removed and checked prior to using the machine. Check electrode wear, insulator color, and negative to positive electrode gap.

## SECTION F. IGNITION TIMING

Ignition timing must be set with a dial indicator (to determine piston position). Proceed as follows:

1. Remove spark plug and screw Dial Gauge Stand into spark plug hole.
2. Insert Dial Gauge Assembly into stand.

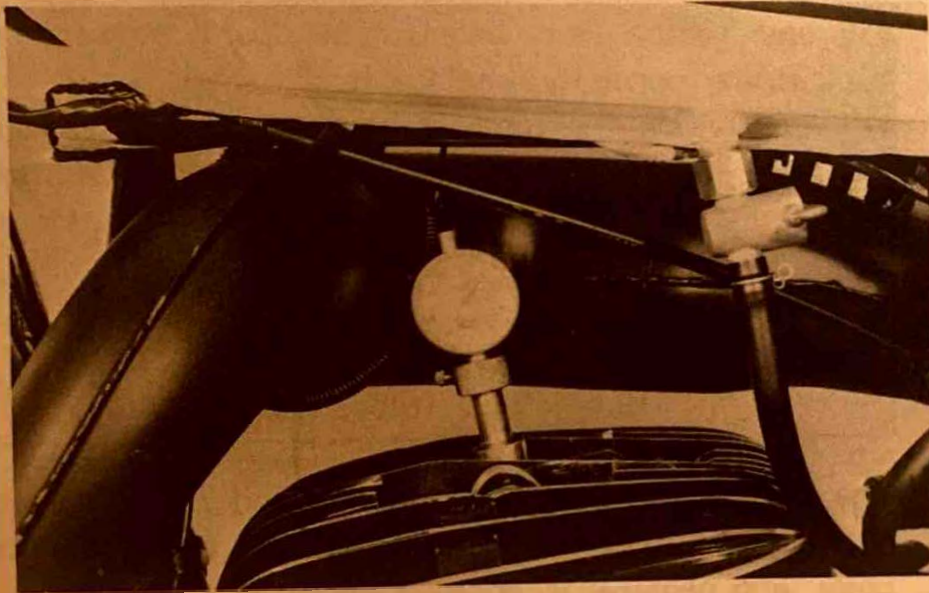

3. Remove left crankcase cover (L).

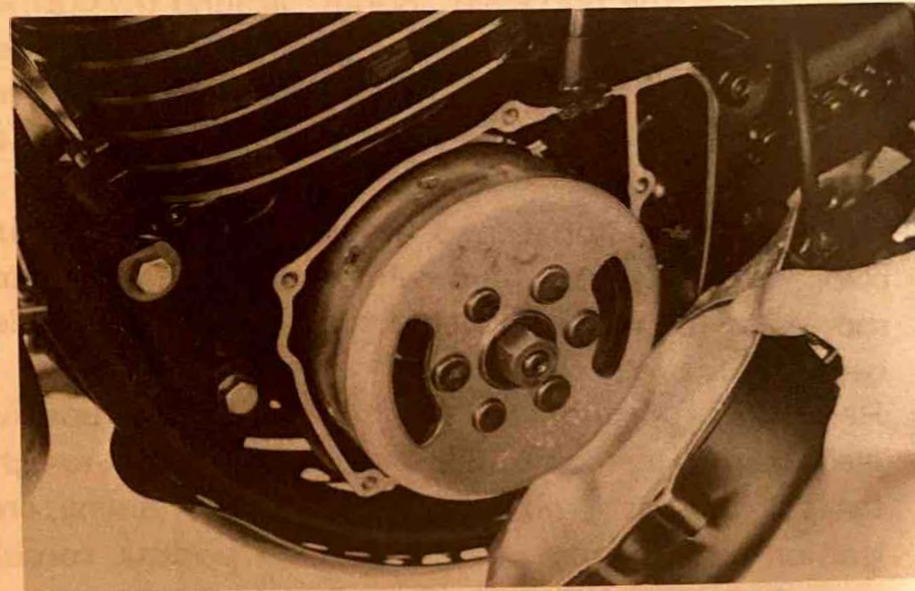

4. Rotate rotor until piston is at top-dead center (T.D.C.). Tighten set screw on spark plug stand to secure dial gauge assembly. Set the zero on dial indicator face to line up exactly with dial indicator needle. Rotate flywheel back and forth to be sure that indicator needle does not go past zero.

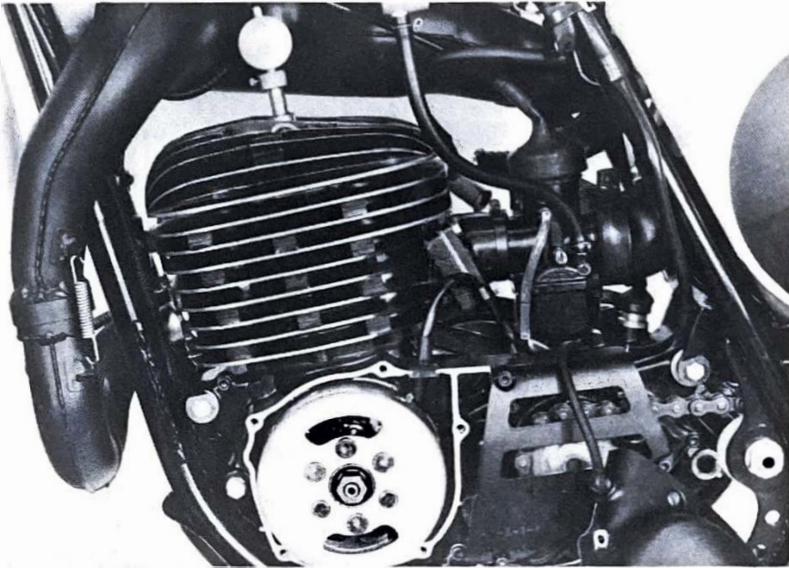

5. Starting at T.D.C., rotate flywheel clockwise until dial indicator reads approximately 0.106 in. (2.7mm.)

**IGNITION TIMING:**

0.106 ± 0.0059 in. (2.7 ± 0.15 mm.) B.T.D.C.

6. Check to see that the rotor timing mark aligns with the pulse coil timing mark. To adjust, loosen the two pulse coil retaining screws and rotate the pulse coil. Tighten screws.

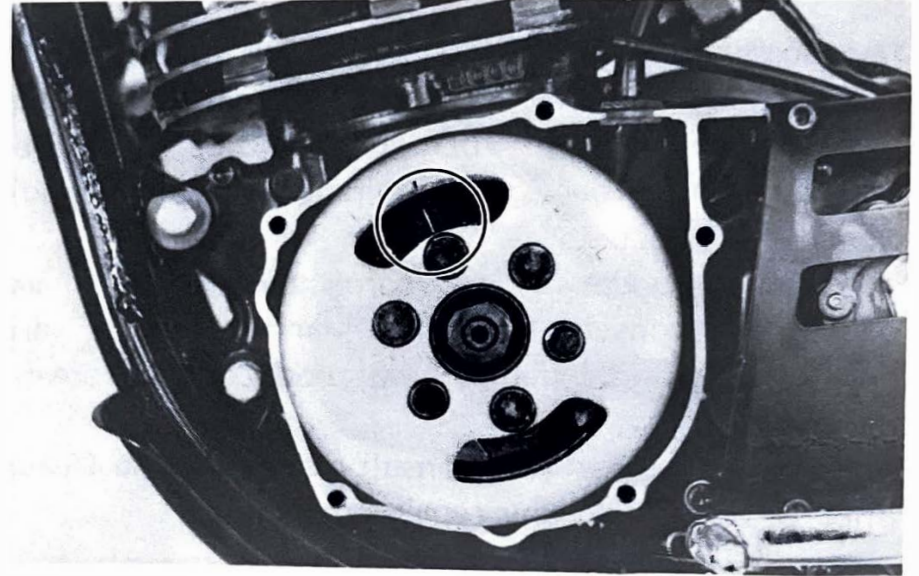

7. Remove dial gauge assembly and stand. Reinstall spark plug.

**SPARK PLUG TORQUE:**

19.5 - 21.0 ft-lbs. (2.7 - 2.9 m-kgs.)

8. Reinstall crankcase cover (L).

## CHAPTER V. ENGINE MAINTENANCE AND MINOR REPAIRS

The following sections provide information for the disassembly, troubleshooting, and maintenance of various components of the machine. If you do not have the necessary tools and an understanding of the mechanical principles involved, please refrain from attempting repairs. The use of improper tools and/or procedures can cause major damage to units with resultant additional repair costs.

To properly understand the procedures outlined, we suggest you consult the Service Manuals and the various other technical publications produced by Yamaha Motor Company.

Finally, we suggest you consult your Yamaha Dealer prior to attempting any repair procedures.

### SECTION A. AIR FILTER

#### 1. REMOVAL

The air filter is a split-type which can be separated into the two sections, right and left. Therefore, it can be replaced one by one.

- a. Remove the screw and number plate.

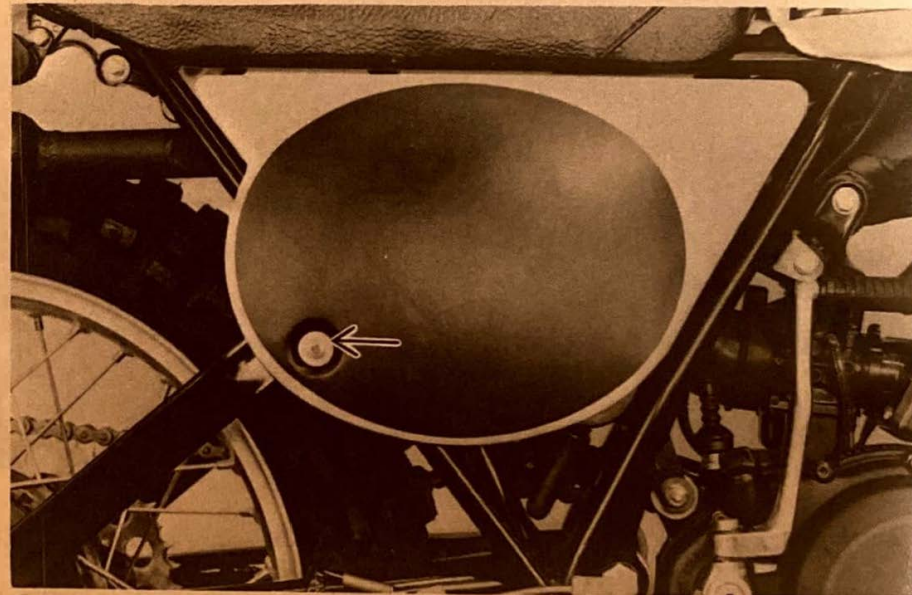

b. To remove the air filter, first remove the nut from the filter case.

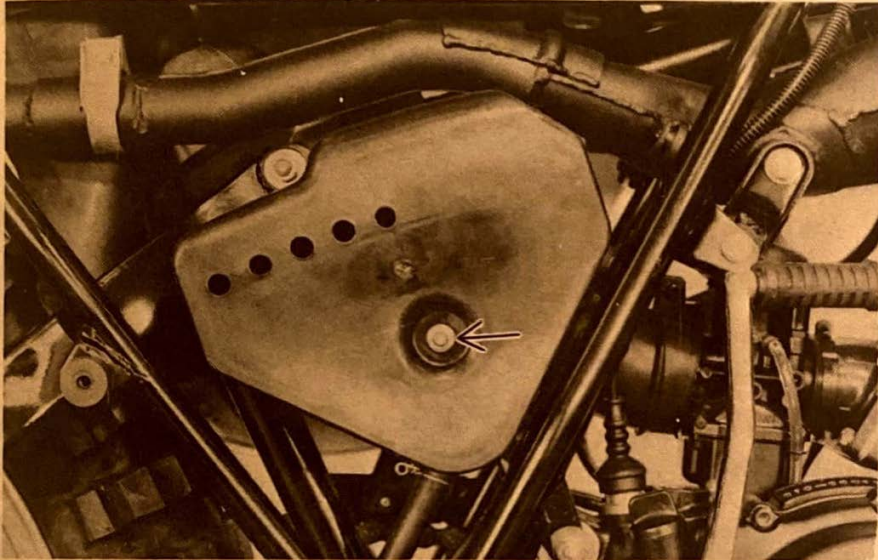

c. Remove the air filter from the filter case.

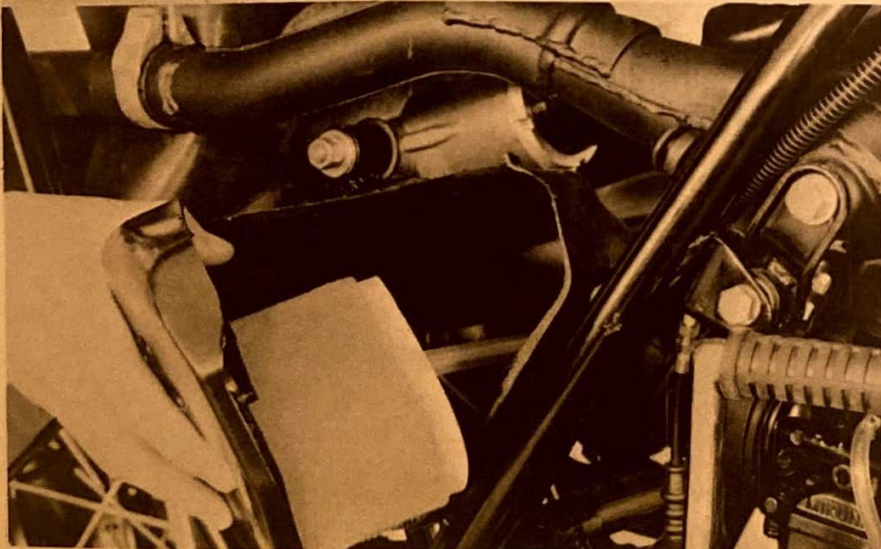

d. Slip the filter from the wire mesh guide.





## 2. CLEANING

- a. Wash the element gently, but thoroughly, in solvent.
- b. Squeeze the excess solvent out of the element and let dry.
- c. Pour a small quantity of 10-30W "SE" motor oil onto the filter element and work thoroughly into the porous foam material.
- d. Re-insert the wire mesh filter element guide into the element.

NOTE

In order to function properly, the element must be damp with oil at all times .....but not "dripping" with oil.

- e. Coat the upper and lower edges of the filter element with light grease. This will provide an air-tight seal between the filter case cover and filter seat.



- f. Reinstall the element assembly and parts removed for access.

NOTE

Each time filter element maintenance is performed, check the air inlet to the filter case for obstructions. Check the air cleaner joint rubber to the carburetor and manifold fittings for an air-tight seal. Tighten all fittings thoroughly to avoid the possibility of unfiltered air entering the engine.

—CAUTION—

NEVER OPERATE THE ENGINE WITH THE AIR FILTER ELEMENT REMOVED. THIS WILL ALLOW UNFILTERED AIR TO ENTER CAUSING RAPID WEAR AND POSSIBLE ENGINE DAMAGE. ADDITIONALLY, OPERATION WITHOUT THE FILTER ELEMENT WILL AFFECT CARBURETOR JETTING WITH SUBSEQUENT POOR PERFORMANCE AND POSSIBLE ENGINE OVER-HEATING.

[www.legends-yamaha-enduros.com](http://www.legends-yamaha-enduros.com)

## SECTION B. CARBURETOR AND REED VALVE

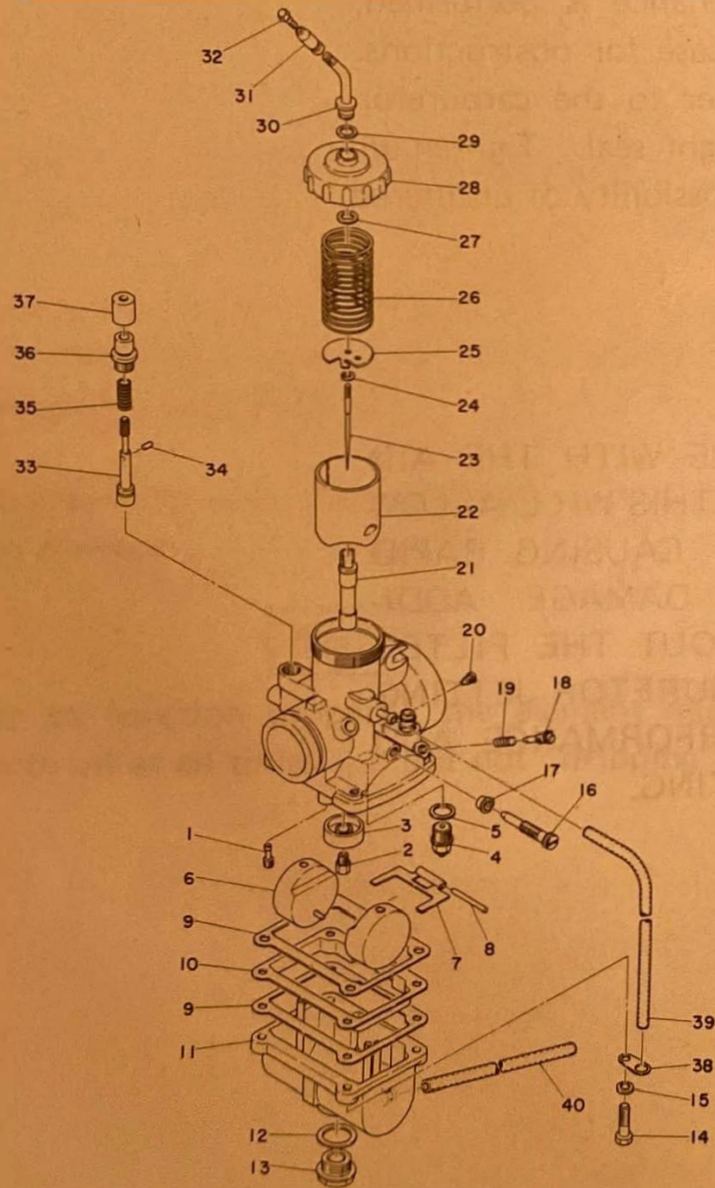

### CARBURETOR

- |                           |                            |
|---------------------------|----------------------------|
| 1. JET, pilot             | 24. CLIP                   |
| 2. JET, main              | 25. SEAT, spring           |
| 3. RING                   | 26. SPRING, throttle valve |
| 4. VALVE SEAT ASS'Y       | 27. CLIP                   |
| 5. WASHER, valve seat     | 28. TOP, mixing chamber    |
| 6. FLOAT                  | 29. PACKING                |
| 7. ARM, float             | 30. TUBE, guide wire       |
| 8. PIN, float             | 31. NUT                    |
| 9. GASKET, float chamber  | 32. SCREW, wire adjusting  |
| 10. PLATE                 | 33. PLUNGER, starter       |
| 11. BODY, float chamber   | 34. PIN                    |
| 12. WASHER, screw plug    | 35. SPRING, plunger        |
| 13. PLUG, screw           | 36. CAP, plunger           |
| 14. SCREW, panhead        | 37. COVER, plunger cap     |
| 15. WASHER, spring        | 38. PLATE                  |
| 16. SCREW, throttle       | 39. PIPE, air vent         |
| 17. NUT, wire adjusting   | 40. PIPE, over flow        |
| 18. SCREW, air adjusting  |                            |
| 19. SPRING, air adjusting |                            |
| 20. JET, air              |                            |
| 21. NOZZLE, main          |                            |
| 22. VALVE, throttle       |                            |
| 23. NEEDLE                |                            |

## 1. CARBURETOR

- a. Turn fuel petcock lever to the "OFF" position.
- b. Remove the gasoline tank fuel line from the fitting at the carburetor.
- c. Unscrew the mixing chamber top.  
Remove the throttle valve and needle assembly.
- d. Loosen the manifold and inlet joint bands (hose clamps).

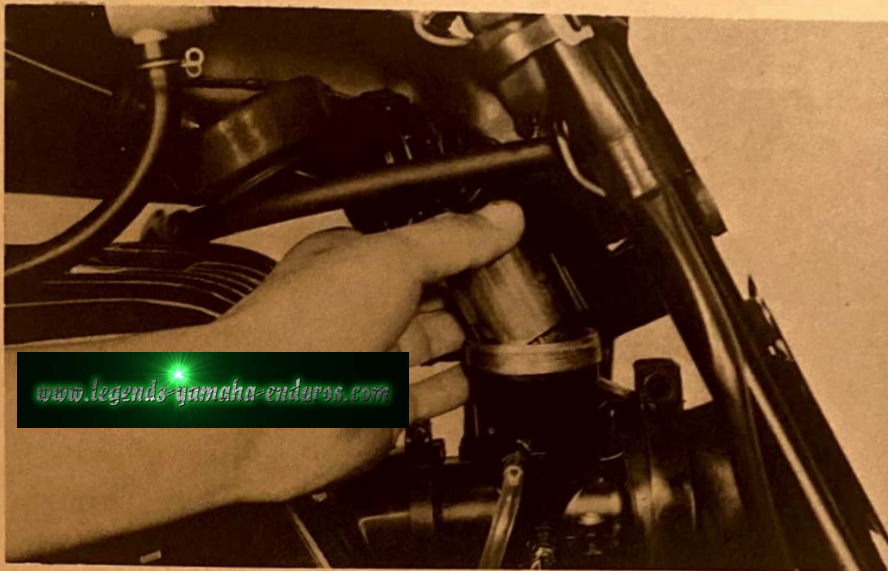

### NOTE

For carburetor main jet replacement only, follow steps "a" through "d" then:

- (1) Rotate carburetor, exposing main jet cover bolt.
- (2) Remove bolt. Main jet is located directly behind bolt.

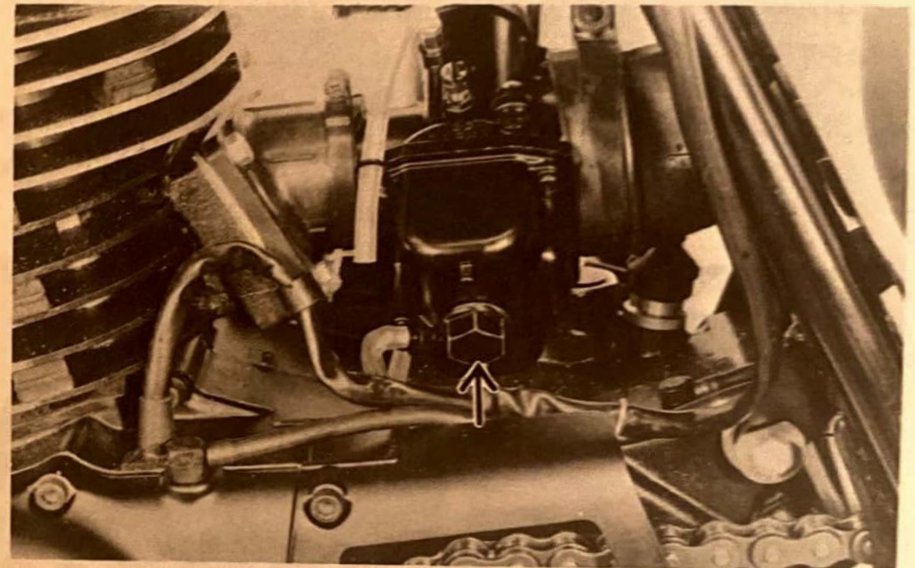

## WARNING

REMOVING THE MAIN JET COVER BOLT WILL ALLOW THE FUEL IN THE FLOAT BOWL TO DRAIN. DO NOT REMOVE IF ENGINE IS HOT. PLACE A RAG UNDER CARBURETOR TO CATCH OVERFLOW. REMOVE BOLT IN WELL-VENTILATED AREA. DO NOT REMOVE NEAR OPEN FRAME. ALWAYS CLEAN AND DRY MACHINE AFTER REASSEMBLY.

- (3) Using a 7 mm. socket or "Spin-tite," remove the main jet. Change as required. Reinstall cover bolt and reassemble, reversing steps 1 through 3.

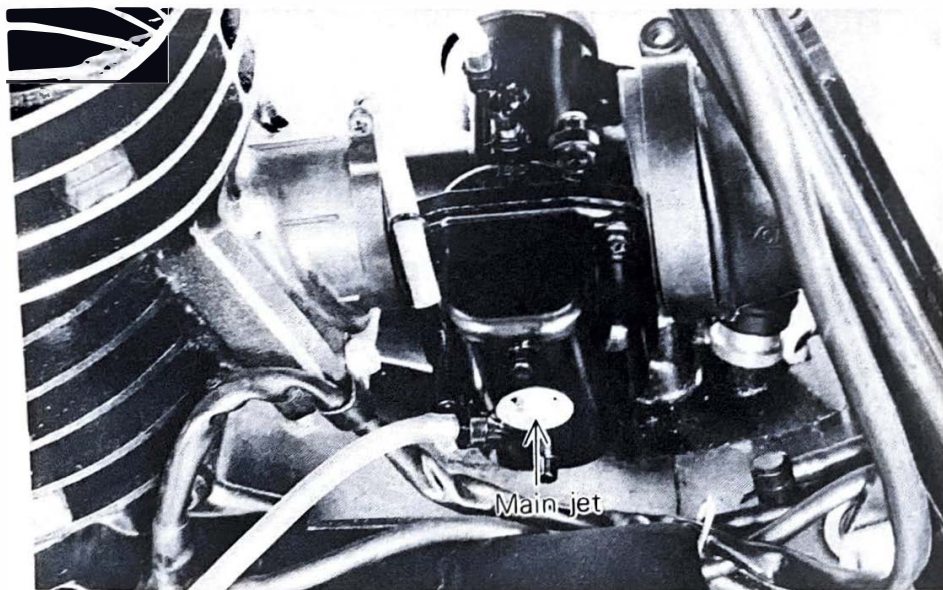

MAIN JET: # 350

- e. Push the air cleaner joint (hose) off the carburetor inlet.
- f. Rotating the carburetor body, work it off the cylinder manifold joint.
- g. Noting the presence, location, and routing of all vent and overflow tubes, pull the carburetor toward you.

[www.legends-yamaha-enduros.com](http://www.legends-yamaha-enduros.com)

- h. Remove the main jet cover bolt and drain the float bowl fuel into suitable receptacle.
- i. Remove the Phillips screws (4) holding float bowl to body. Remove float bowl.

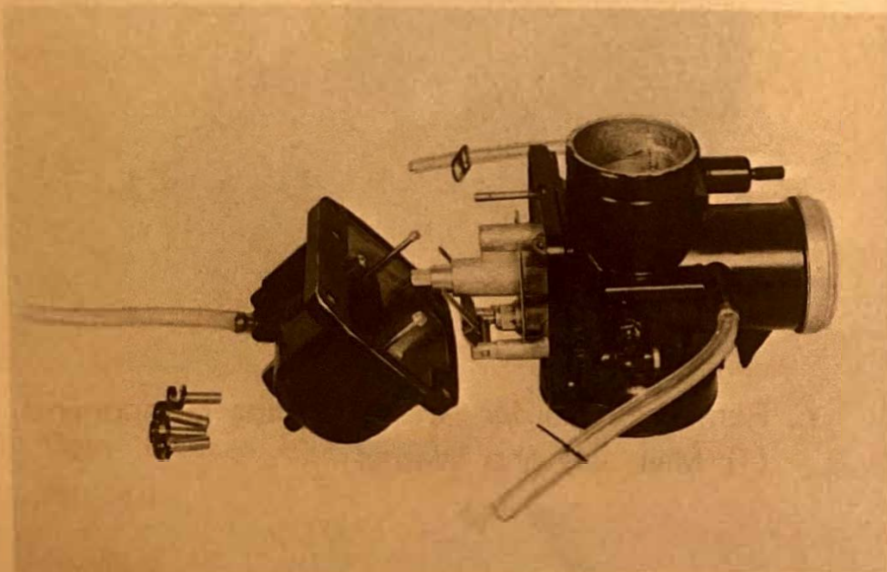

- j. Carefully set body aside and inspect each independent float within the float bowl cavity. Note their installation position. The float arm pin must be on the lower side of the float and in, towards the center.

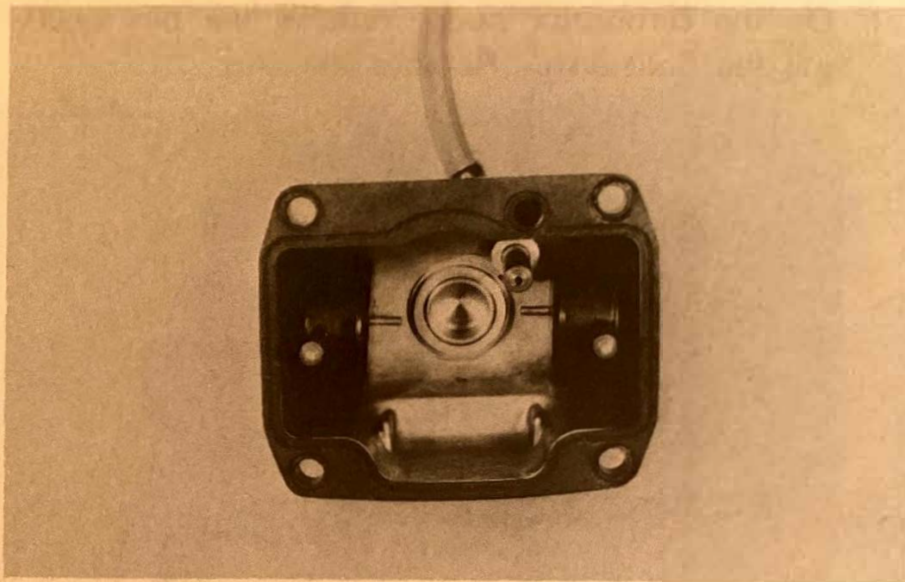

- k. Check each float. If fuel has entered a float, replace it. If a pin is loose or missing, or if the floats are damaged in any fashion, replace them.

[www.legends-yamaha-enduros.com](http://www.legends-yamaha-enduros.com)

- l. On the carburetor body, remove the pin securing the float arm. Remove the arm.

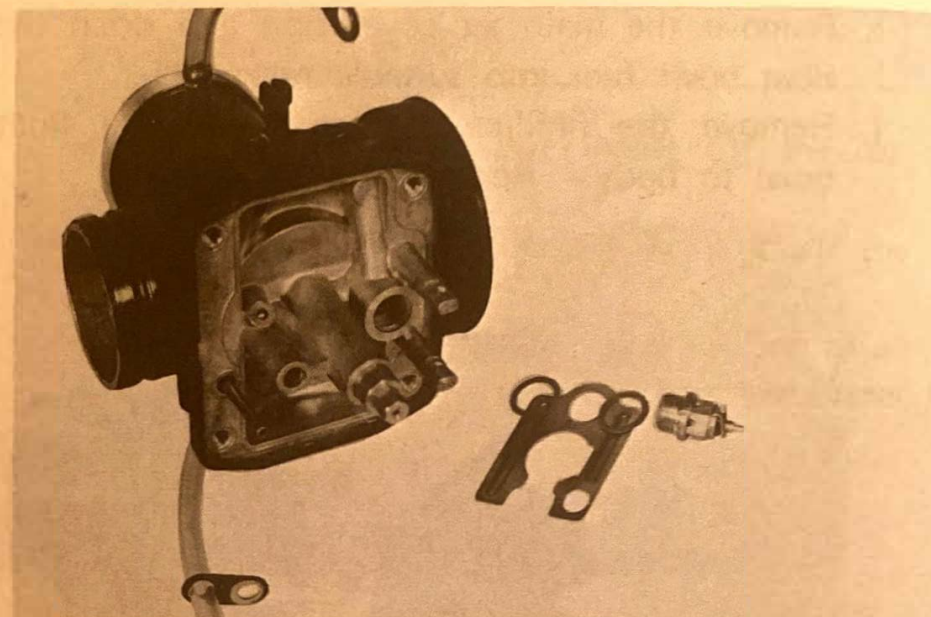
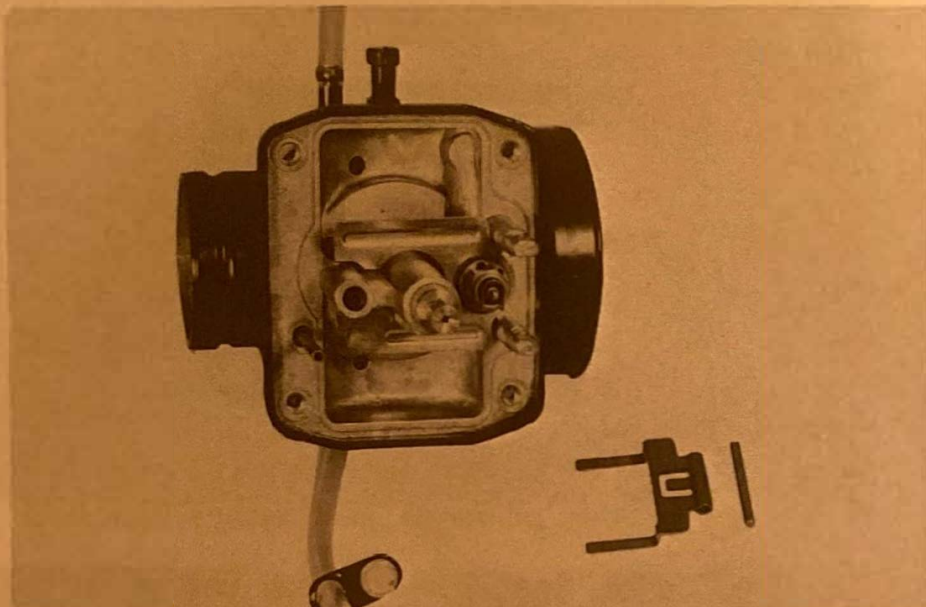

- n. Remove, in order, the following components.  
(1) Main Jet and Washer

- m. Remove the inlet needle directly beneath the float arm tang. Inspect the needle and seat for signs of excessive wear or attached foreign particles. Replace as required. Replace inlet needle and inlet valve seat as an assembly.

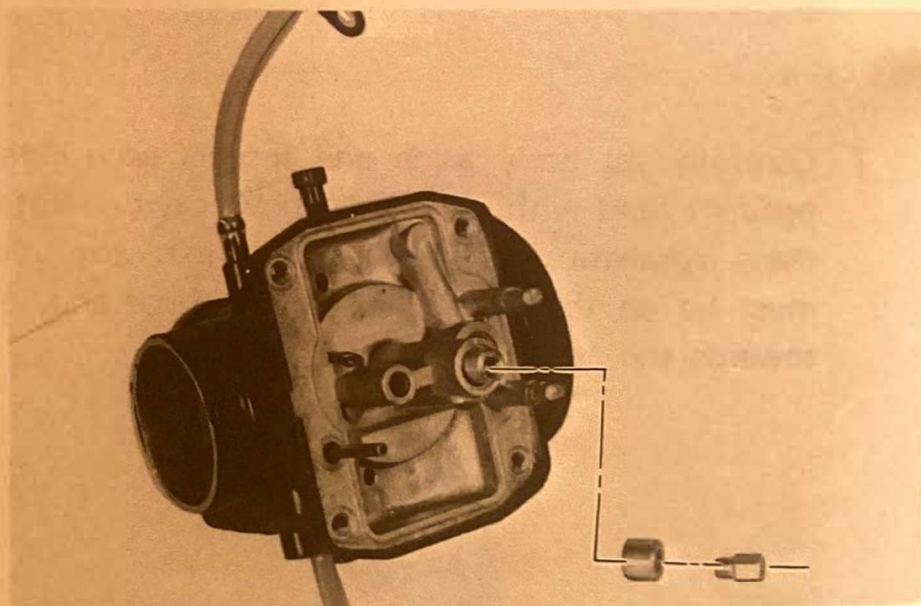

(2) Pilot Jet

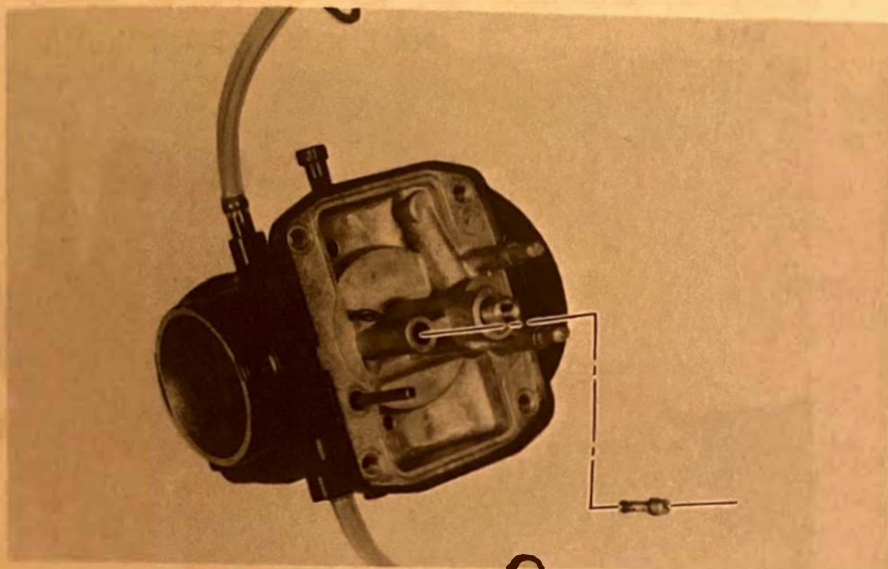

(4) Throttle Screw (Idle Speed Screw)

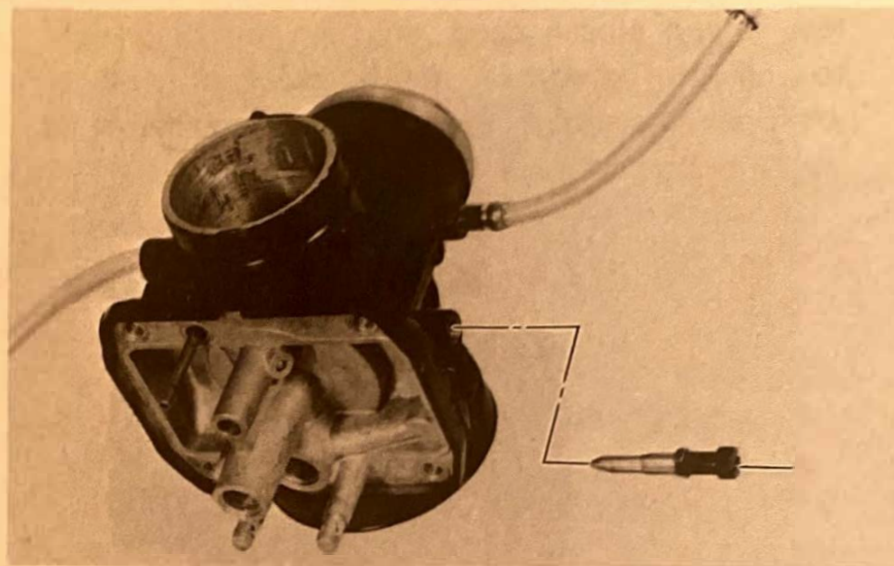

(3) Main Nozzle (push from bottom through venturi).

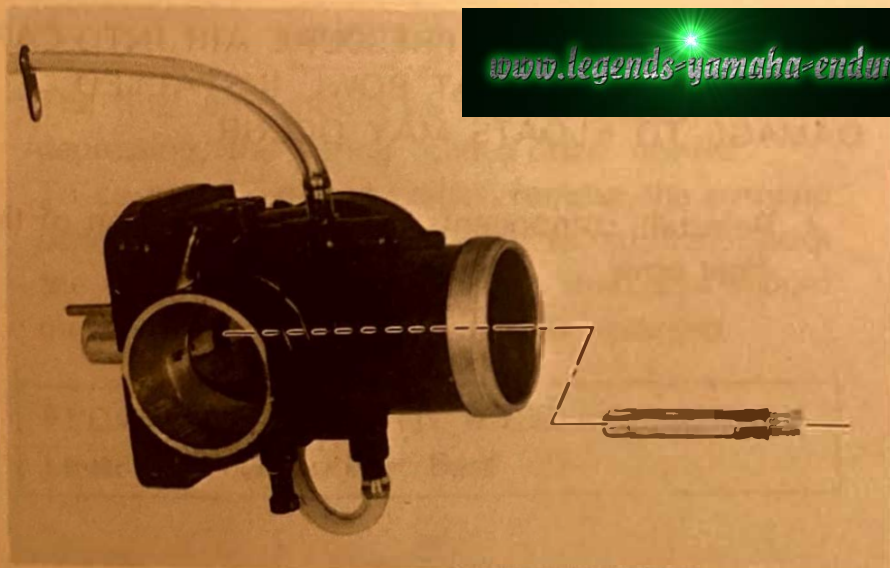

[www.legends-yamaha-enduros.com](http://www.legends-yamaha-enduros.com)

(5) Air Adjusting Screw (Idle Mixture Screw)

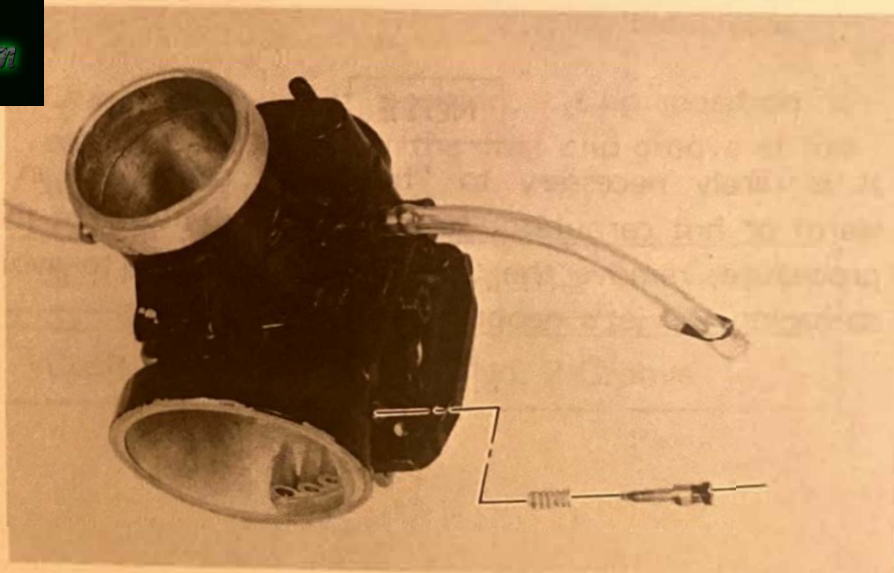



o. Actuate the Starter Jet control to open the circuit.

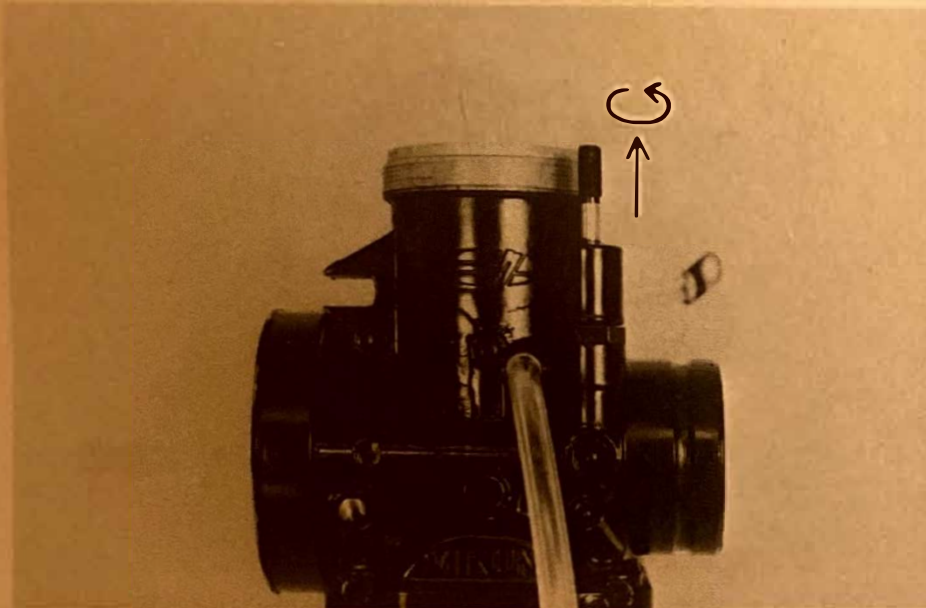

p. Wash the carburetor in mild solvent. Wash all associated parts.

NOTE

It is rarely necessary to “boil” the carburetor in a warm or hot carburetor bath. If deposits warrant this procedure, remove the Starter Jet Assembly to avoid damaging the jet’s neoprene valve seat.

q. Using high pressure air, blow out all passages and jets.



—CAUTION—

NEVER DIRECT HIGH PRESSURE AIR INTO CARBURETOR WITH FLOAT BOWL INSTALLED. DAMAGE TO FLOATS MAY OCCUR.

r. Reinstall components, with the exception of the float bowl.

- s. Check to ensure that the float arm is parallel with the carburetor base.

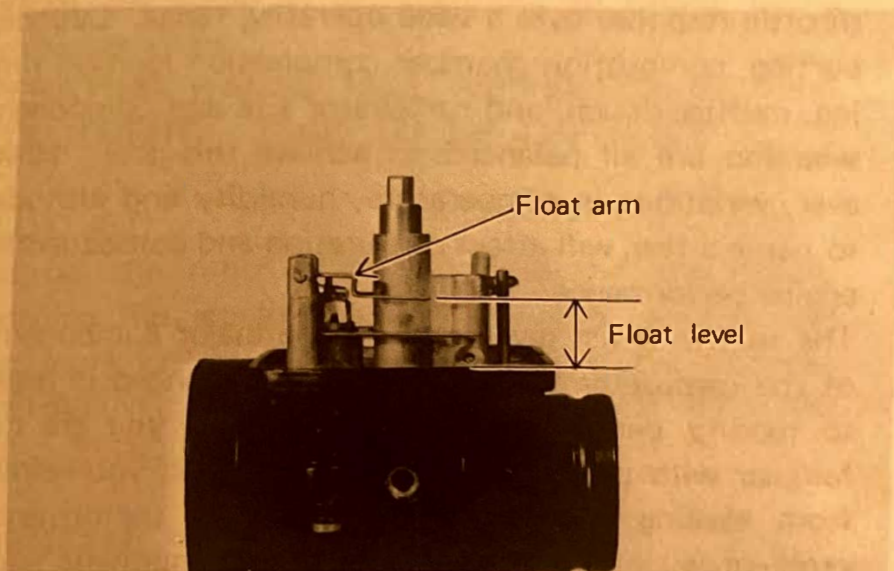

**NOTE**

The float arm should be just resting on, but not depressing, the spring loaded inlet needle. To correct float arm height, remove the arm and bend the tang a slight amount as required. Both the right and left sides of the float arm should measure identically. Correct as required.

FLOAT ARM HEIGHT: 0.709 in. (18 mm.)  
Level With Carburetor Base

- t. Install the float bowl and main jet cover bolt.  
u. Moving to the machine, push needle out of seat in throttle valve (slide). Inspect for signs of bending, scratches or wear. Replace as required.

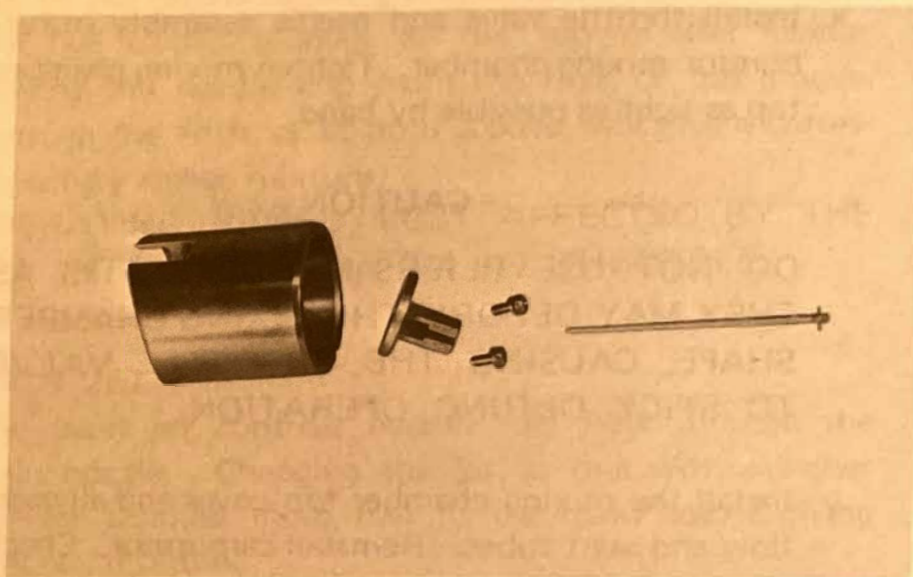

- v. Check needle clip position. Clip position is counted starting with the first clip groove at the top of the needle.

JET NEEDLE TYPE: 6F16-2

CLIP POSITON: No. 2 Groove

[www.legends-yamaha-enduros.com](http://www.legends-yamaha-enduros.com)

- w. Check throttle valve (slide) for signs of wear. Insert into carburetor body and check for free movement. If slide, or body, is out of round causing slide to stick, replace as required.
- x. Install throttle valve and needle assembly in carburetor mixing chamber. Tighten mixing chamber top as tight as possible by hand.

—CAUTION—

DO NOT USE PLIERS OR VISE-GRIPS AS THEY MAY DEFORM THE MIXING CHAMBER SHAPE, CAUSING THE THROTTLE VALVE TO STICK DURING OPERATION.

- y. Install the mixing chamber top cover and all overflow and vent tubes. Reinstall carburetor. Check tightness of all fittings. Make sure carburetor is mounted in a level position.

NOTE

After installation, check throttle cable adjustment and check to ensure that slide is free by turning and releasing throttle.

## TROUBLESHOOTING

A Motocross machine requires immediate, predictable throttle response over a wide operating range. Cylinder porting, combustion chamber compression ignition timing, muffler design, and carburetor size and component selection are all balanced to achieve this goal. However, variations in temperature, humidity and altitude, to name a few, will affect carburetion and consequently, engine performance.

The following list gives each of the major components of the carburetor that can be readily changed in order to modify performance if required. If you are unfamiliar with carburetor theory, we suggest you refrain from making changes. Quite often, a performance problem is caused by another related component, such as the exhaust system, ignition timing or combustion chamber compression.

NOTE

See MECHANICAL ADJUSTMENTS for additional carburetor adjustments.

#### IDLE AIR MIXTURE SCREW:

Controls the ratio of air-to-fuel in the idle circuit. Turning the screw in decreases the air supply giving a richer mixture.

OPERATING RANGE MOST AFFECTED BY THIS ADJUSTMENT: ZERO TO 1/8 THROTTLE.

#### PILOT JET:

Controls the ratio of fuel-to-air in the idle circuit. Changing the jet to one with a higher number supplies more fuel to the circuit giving a richer mixture.

OPERATING RANGE MOST AFFECTED BY THIS JET: ZERO TO 1/8 THROTTLE.

#### THROTTLE VALVE (Slide):

The throttle valve (slide) has a portion of the base cut away to control air flowing over the main nozzle. A wider angle (more "cutaway") will create a leaner mixture. Throttle valves are numbered according to the angle of the cutaway. The higher the number, the more cutaway, the leaner the mixture.

OPERATING RANGE MOST AFFECTED BY THE THROTTLE VALVE: 1/8 to 1/4 (+) THROTTLE.

#### JET NEEDLE:

The jet needle is fitted within the throttle valve. The tapered end of the needle fits into the main nozzle outlet. Raising the needle allows more fuel to flow out of the nozzle outlet giving a richer mixture. There are five circlip grooves at the top of the needle. Moving the needle clip from the first, or top groove, through the fifth, or bottom groove, will give a correspondingly richer mixture.

OPERATING RANGE MOST AFFECTED BY THE JET NEEDLE: 1/4 to 3/4 (+) THROTTLE.

#### MAIN JET:

The main jet controls overall fuel flow through the main nozzle. Changing the jet to one with a higher number supplies more fuel to the main nozzle giving a richer mixture.

OPERATING RANGE MOST AFFECTED BY THE MAIN JET: 3/4 TO FULL THROTTLE.

#### NOTE

Excessive changes in main jet size can affect performance at all throttle positions.

**—CAUTION—**

THE FUEL/AIR MIXTURE RATIO IS A GOVERNING FACTOR UPON ENGINE OPERATING TEMPERATURE. ANY CARBURETOR CHANGES, WHATSOEVER, MUST BE FOLLOWED BY A THOROUGH SPARK PLUG TEST.

**2. REED VALVE**

- a. With carburetor removed, remove the four (4) bolts holding the intake manifold and reed valve assembly to the cylinder. Remove the reed valve assembly.

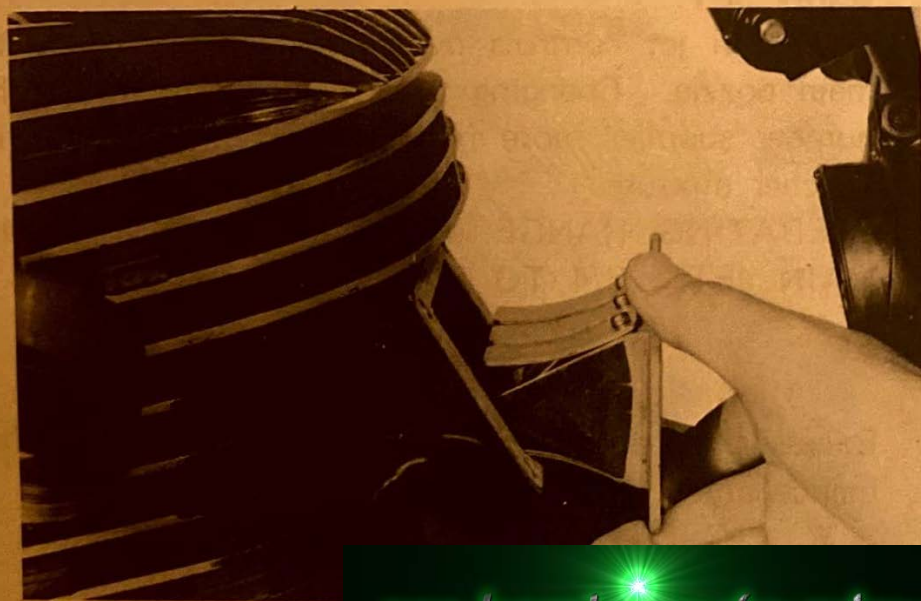

[www.legends-yamaha-enduros.com](http://www.legends-yamaha-enduros.com)

- b. Inspect reed petals for signs of fatigue cracks. Reed petals should fit flush or nearly flush against neoprene seats. If in doubt as to sealing ability, apply suction to carburetor side of assembly. Leakage should be slight to moderate.

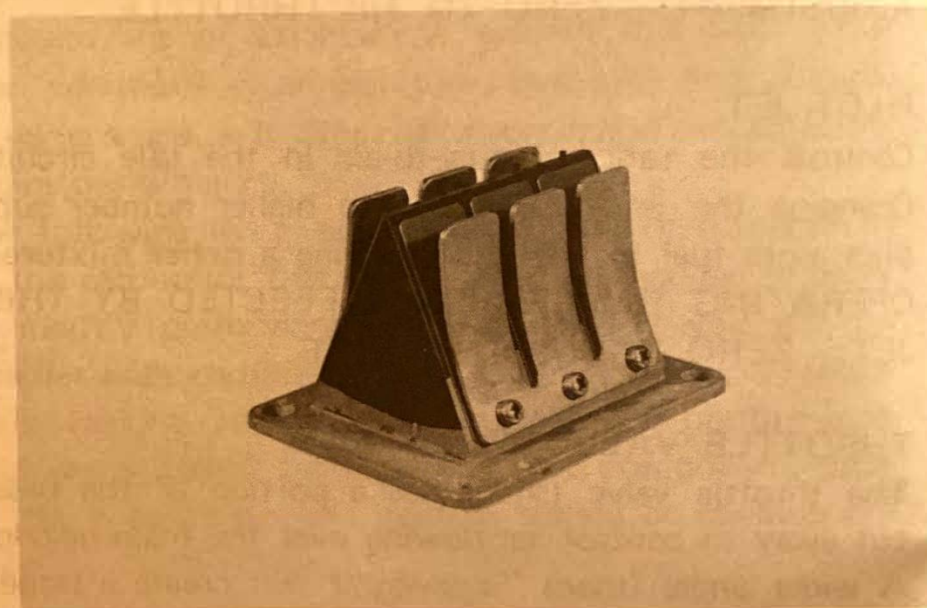

- c. If disassembly of the reed valve assembly is required, proceed as follows.
  - (1) Remove phillips screws (3) securing stopper plate and reed to reed block. Handle reed carefully. Avoid scratches and do not bend. Note from which side of the reed block the reed and stopper plate were removed. Reinstall on same side.

(2) During reassembly, clean reed block, reed, and stopper plate thoroughly. Apply a holding agent, such as "Lock-Tite," to threads of phillips screws. Tighten each screw gradually to avoid warping. Tighten the screws thoroughly.

**—CAUTION—**

DO NOT OVER-TIGHTEN SECURING SCREWS, STOPPER PLATES MAY WARP.

**SECURING SCREW TORQUE:**

6.9 in-lbs. (8.0 cm-kg.)

**NOTE**

During reassembly, observe the cut in the lower corner of the reed and stopper plate. Use as aid to direction of reed installation.

[www.legends-yamaha-enduros.com](http://www.legends-yamaha-enduros.com)

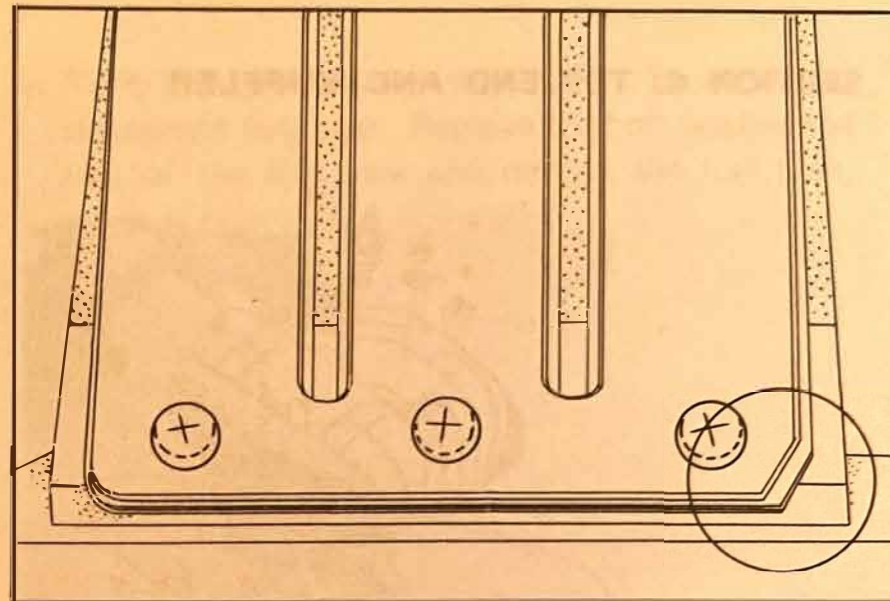

d. During reassembly of the reed valve assembly and manifold, install new gaskets and torque the securing bolts gradually and in pattern.

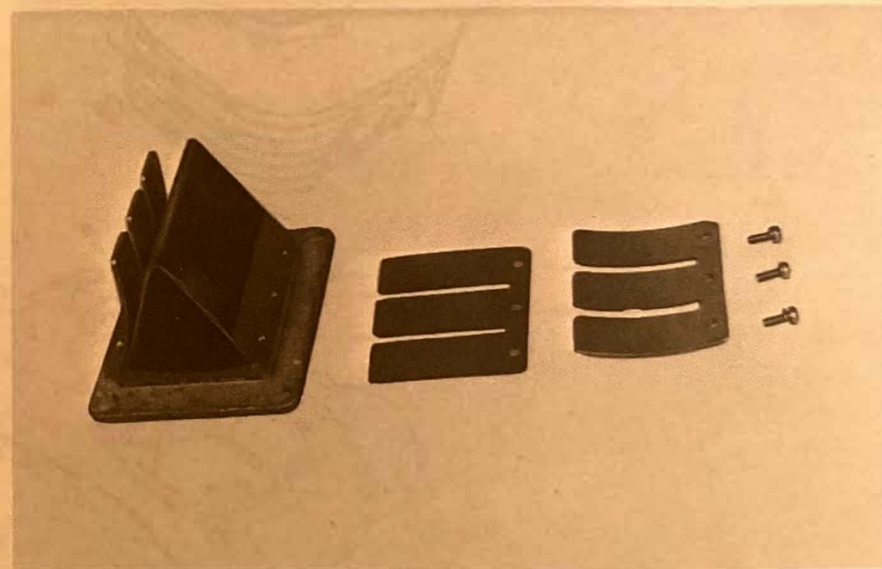

## SECTION C. TOP END AND MUFFLER

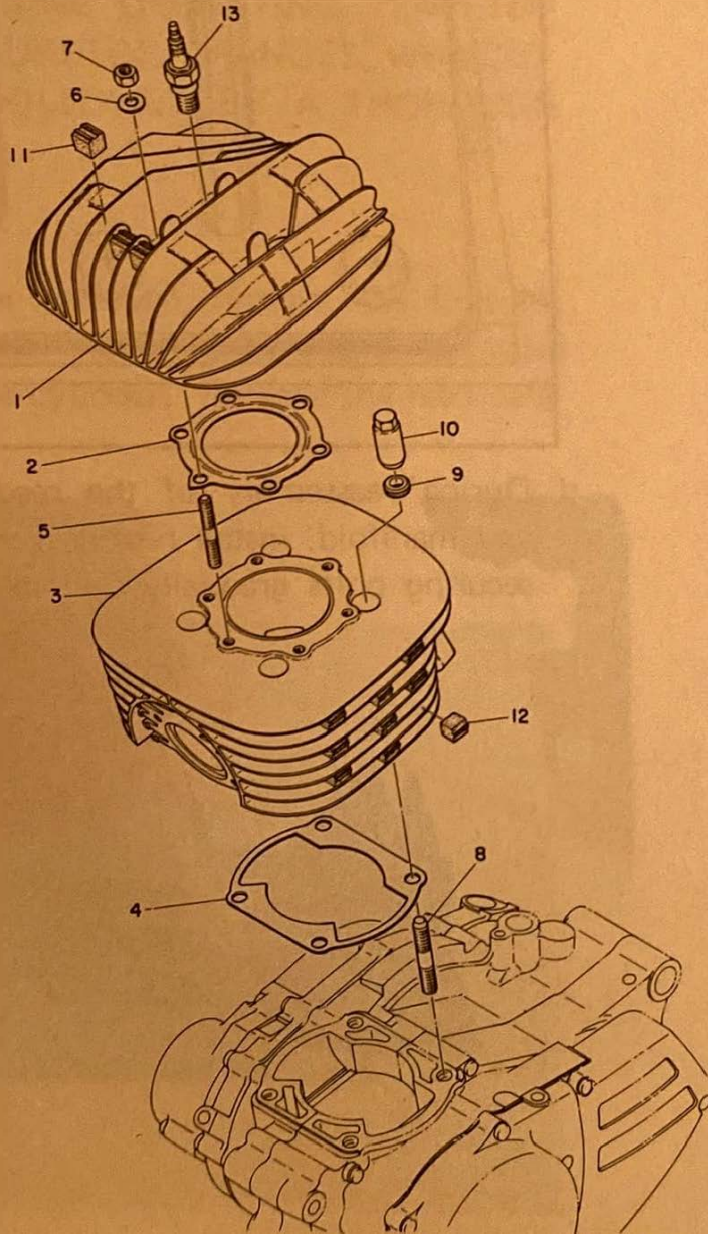

## CYLINDER HEAD - CYLINDER

1. HEAD, cylinder
2. GASKET, cylinder head
3. CYLINDER
4. GASKET, cylinder
5. BOLT, stud
6. WASHER, holding
7. NUT
8. BOLT, cylinder holding
9. WASHER, holding
10. NUT, holding
11. ABSORBER (B-8EV)
12. ABSORBER
13. PLUG, spark (B-8EV)

[www.legends-yamaha-enduros.com](http://www.legends-yamaha-enduros.com)

## 1. MUFFLER AND CYLINDER HEAD REMOVAL (Carburetor Removed)

### NOTE

Before removing the muffler remove the spark plug lead wire and spark plug.

- a. Remove the two bolts and remove seat.



- b. Turn fuel petcock to the "OFF" position and disconnect fuel pipe. Remove the bolt holding the rear of the fuel tank and remove the fuel tank.



[www.legends-yamaha-enduros.com](http://www.legends-yamaha-enduros.com)



c. Lift rear of fuel tank up and pull back to clear frame mounts. Remove tank.



d. Remove the muffler mounting three bolts.

NOTE

Remove the spark plug lead wire and spark plug before removing the muffler.

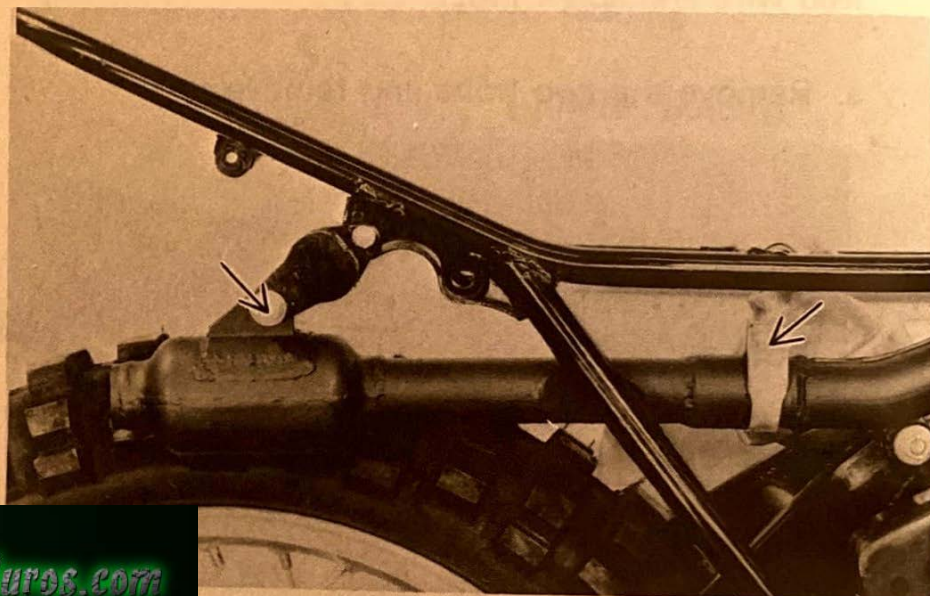

[www.legends-yamaha-enduros.com](http://www.legends-yamaha-enduros.com)



e. Remove coil spring at muffler to cylinder joint.

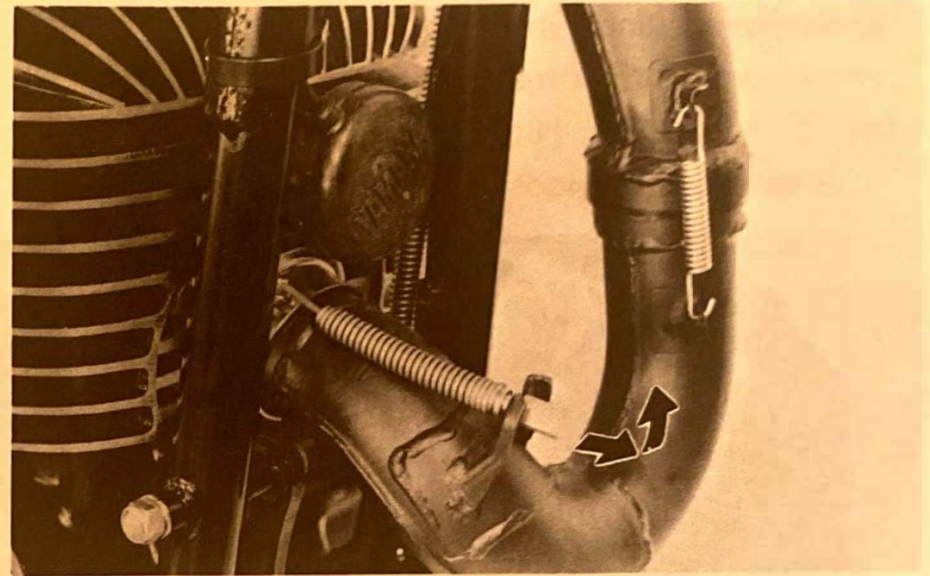

f. Remove coil spring securing muffler to frame and remove muffler.

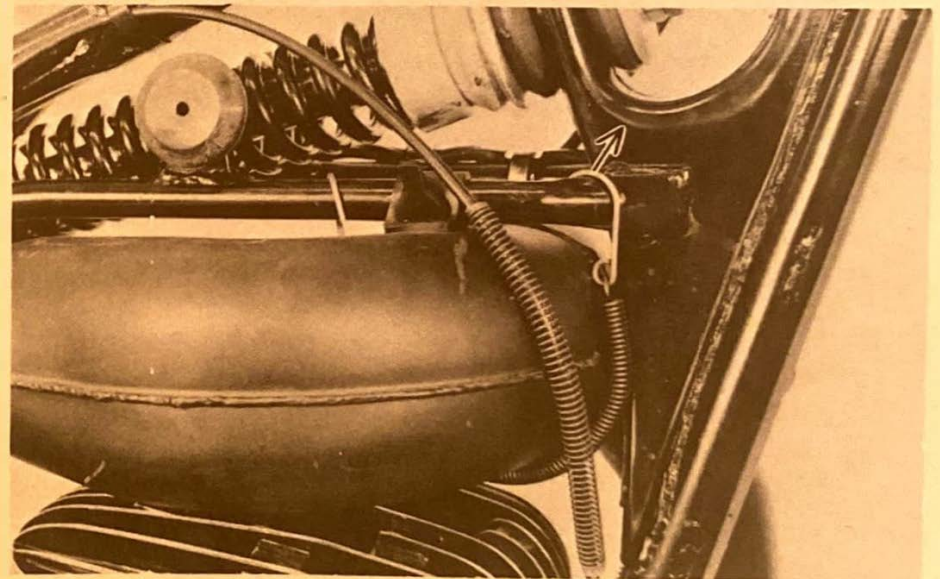
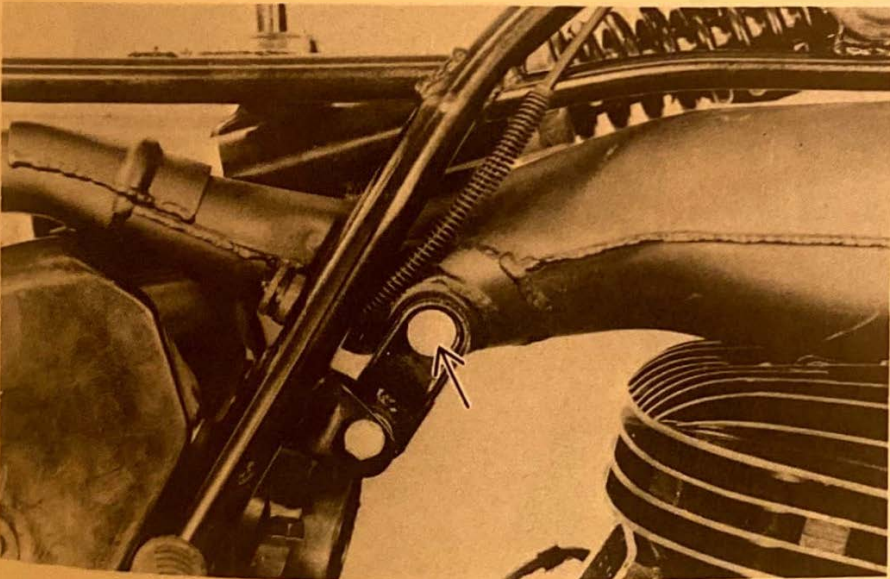

- g. Remove nuts securing cylinder and head, 6 nuts.  
Remove cylinder head and gasket.

NOTE

Break each nut loose (1/4 turn) prior to removing.

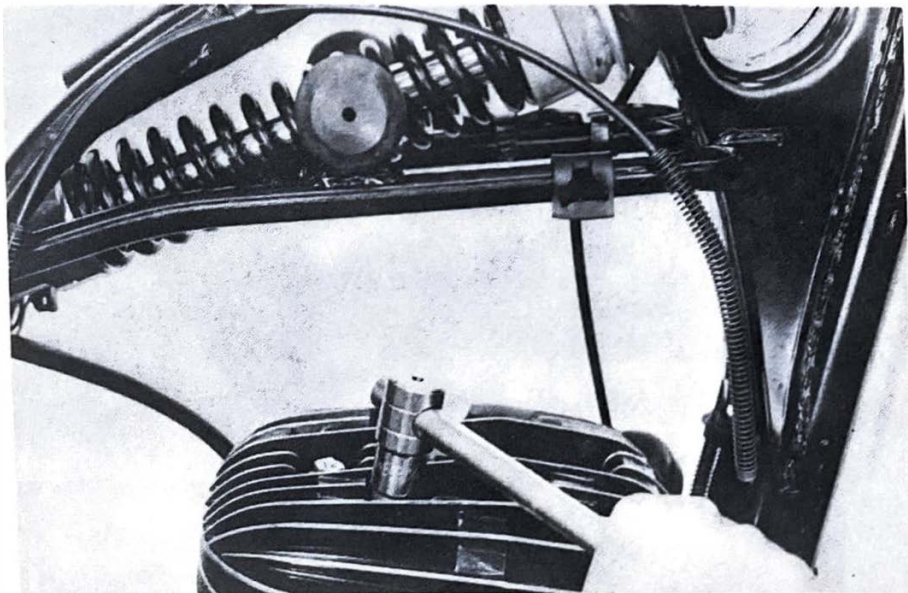

## 2. CYLINDER REMOVAL

a. Remove decompression wire.



[www.legends-yamaha-enduros.com](http://www.legends-yamaha-enduros.com)

b. Remove the cylinder holding nuts.

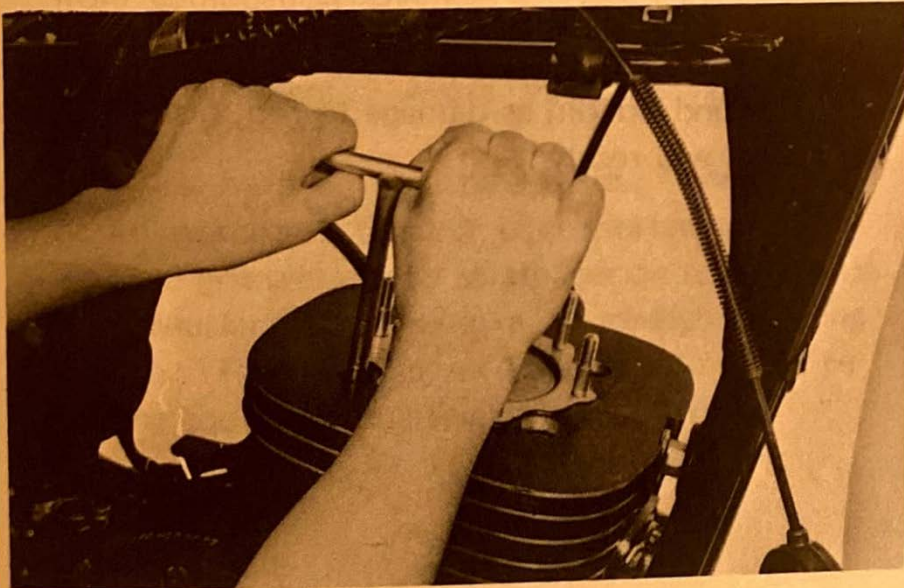

c. With the piston at top dead center, raise the cylinder until the cylinder skirts clear crankcase. Stuff a clean shop rag into crankcase cavity, around rod, to prevent dirt and other foreign particles from entering. Remove cylinder.



- d. Remove the wrist pin clip (1) from the piston. Push the wrist pin out from opposite side. Remove the piston.

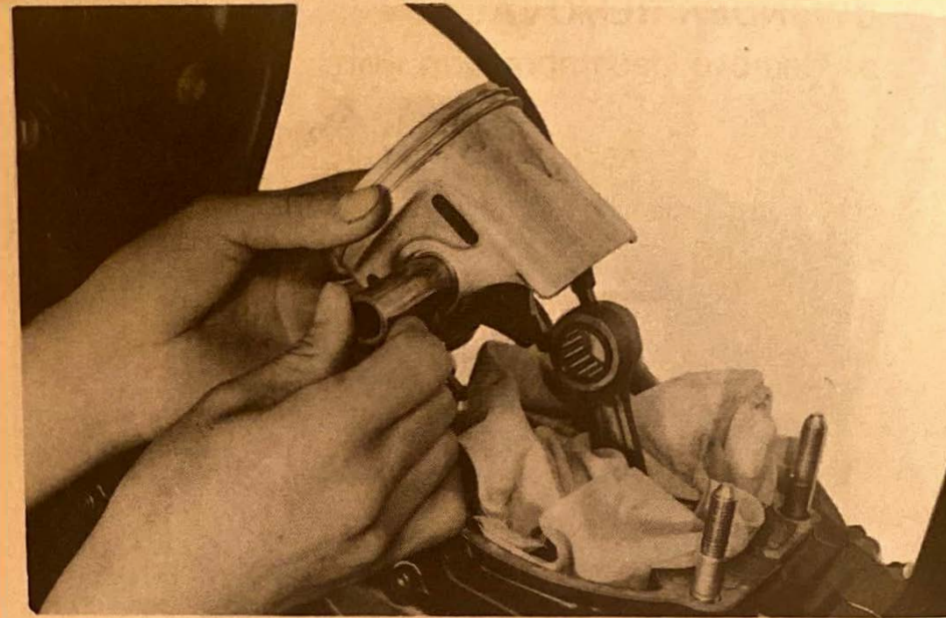

NOTE

If the pin hangs up, use a wrist pin puller. Do not pound on pin as damage to rod, piston and bearing will result.

### 3. MAINTENANCE - EXHAUST PIPE

- a. Using a rounded scraper, remove excess carbon deposits from manifold area of exhaust pipe. Check muffler gasket condition. The gasket seat is located around the cylinder exhaust port.
- b. Carbon deposits within the silencer may be removed by lightly tapping the outer shell with a hammer and then blowing out with compressed air. Heavy wire, such as a coat hanger, may be inserted to break loose deposits. Use care.
- c. Reinstall muffler.

### 4. MAINTENANCE - CYLINDER HEAD

- a. Remove spark plug.
- b. Using a rounded scraper, remove carbon deposits from combustion chamber. Take care to avoid damaging the spark plug threads. Do not use a sharp instrument. Avoid scratching the metal surface.
- c. Place the head on a surface plate. There should be no warpage. Correct by re-surfacing. Place 400-600 grit wet emery sandpaper on surface plate and re-surface head using a figure-eight sanding pattern. Rotate head several times to avoid removing too much material from one side.



- d. Clean the spark plug gasket mating surface thoroughly.
- e. Wash the head in solvent and wipe dry.
- f. Install new cylinder head gasket during reassembly.

**CYLINDER HEAD NUT TORQUE:**

( 8 mm. NUTS) = 14.5 ft-lbs. (2.0 m-kgs.)

(10 mm. NUTS) = 25.3 ft-lbs. (3.5 m-kgs.)

**5. MAINTENANCE - CYLINDER**

- a. Remove reed valve assembly.

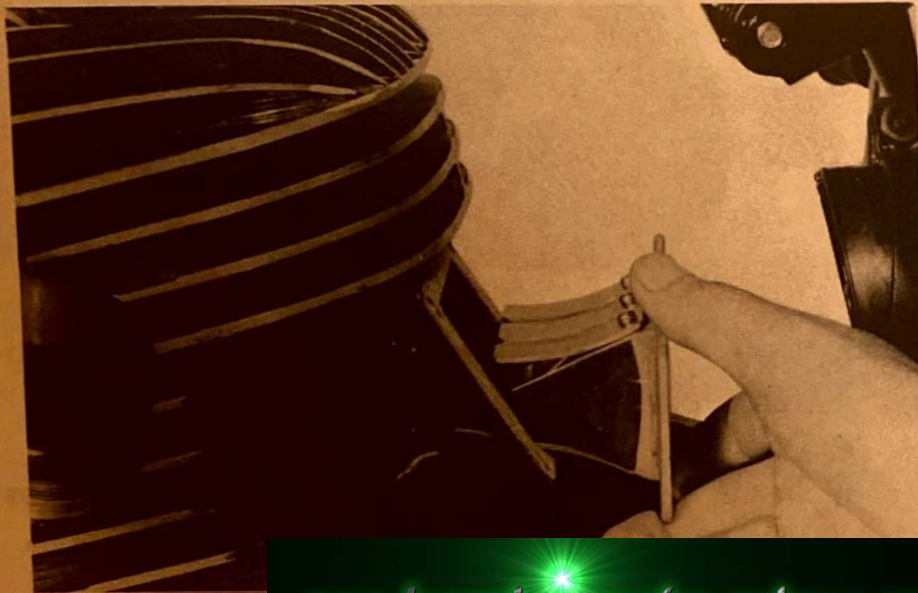

[www.legends-yamaha-enduros.com](http://www.legends-yamaha-enduros.com)

- b. Using a rounded scraper, remove carbon deposits from exhaust port.

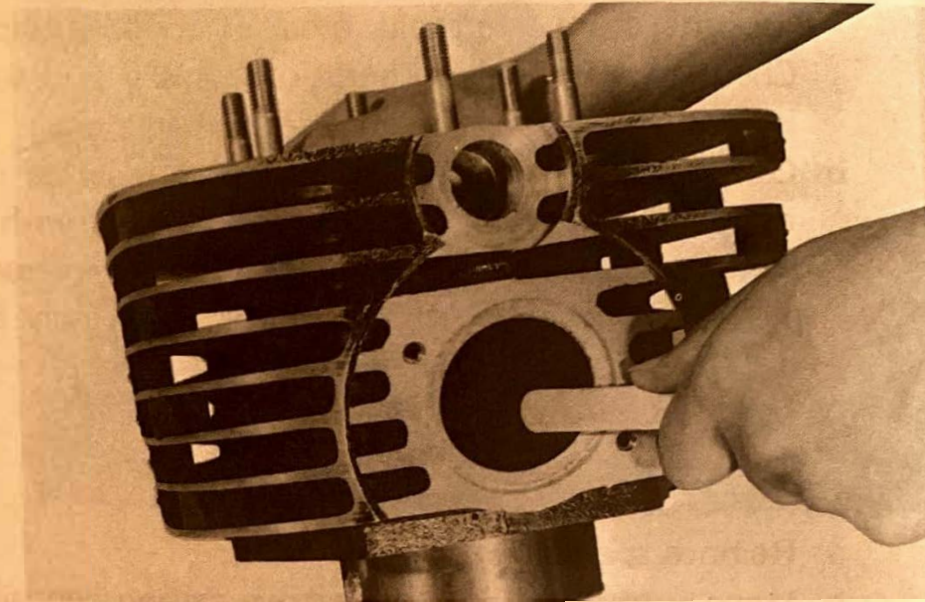

- c. Remove cylinder base gasket and clean gasket seat on cylinder and crankcase thoroughly.
- d. Check cylinder bore. Using a cylinder gauge set to standard bore size, measure the cylinder. Measure at six points; at top, center, and 0.5 in. from bottom of piston, in line with the wrist pin and at right angle to pin. Compare to piston a measurements. If over tolerance, replace piston or cylinder as required.

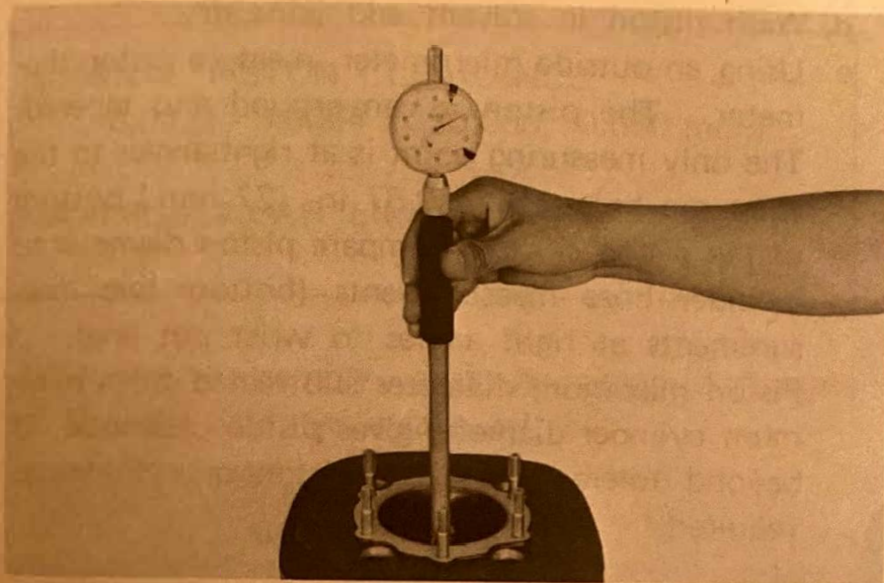

**NOTE**

The cylinder bore is chrome plated directly to the aluminum cylinder and is non-repairable. Any scratches or flaking require replacement of the cylinder.

- e. Clean cylinder in solvent, then wash with hot soapy water. Dry. Coat walls with light oil film.
- f. During re-assembly, always use a new cylinder base gasket.

**6. MAINTENANCE - PISTON**

- a. Using a rounded scraper, remove carbon deposits from piston crown.



[www.legends-yamaha-enduros.com](http://www.legends-yamaha-enduros.com)



- b. Break a used piston ring in two. File end square. De-burr edges to avoid scratching ring groove and clean carbon deposits from ring grooves.



- c. Using 400-600 grit wet sandpaper, lightly sand score marks and lacquer deposits from sides of piston. Sand in cross-hatch pattern. Do not sand excessively.



- d. Wash piston in solvent and wipe dry.
- e. Using an outside micrometer, measure piston diameter. The piston is cam-ground and tapered. The only measuring point is at right-angles to the wrist pin holes about 0.87 in. (22 mm.) bottom of the piston skirts. Compare piston diameter to cylinder bore measurements (bottom two measurements at right angles to wrist pin line). Piston maximum diameter subtracted from minimum cylinder diameter gives piston clearance. If beyond tolerance, replace piston or cylinder as required.

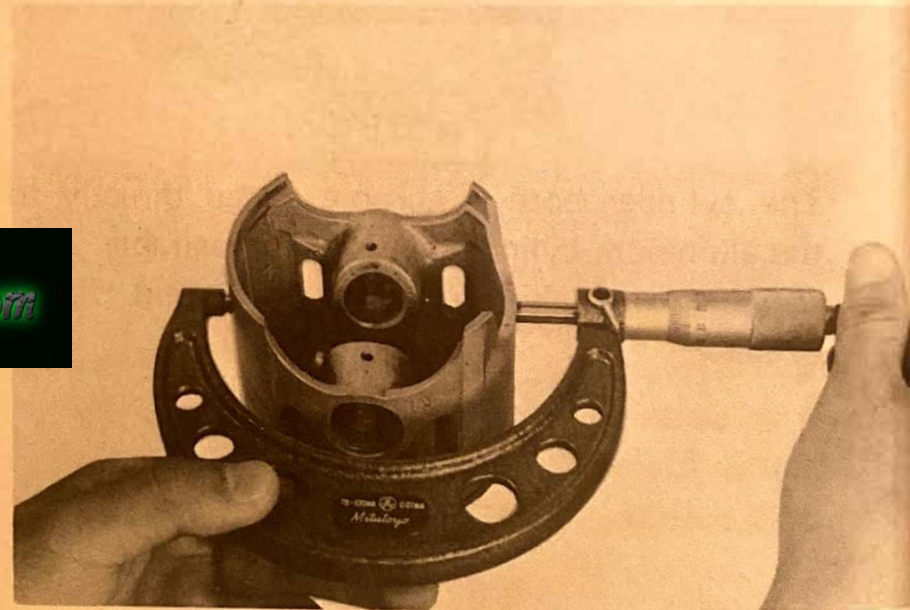

**NOMINAL PISTON CLEARANCE:**

0.0022 - 0.0024 in. (0.055 - 0.060 mm.)

**MAXIMUM WEAR LIMIT:**

0.0039 in. (0.1 mm.)

- f. During re-assembly, coat the piston skirt areas liberally with two-stroke oil.

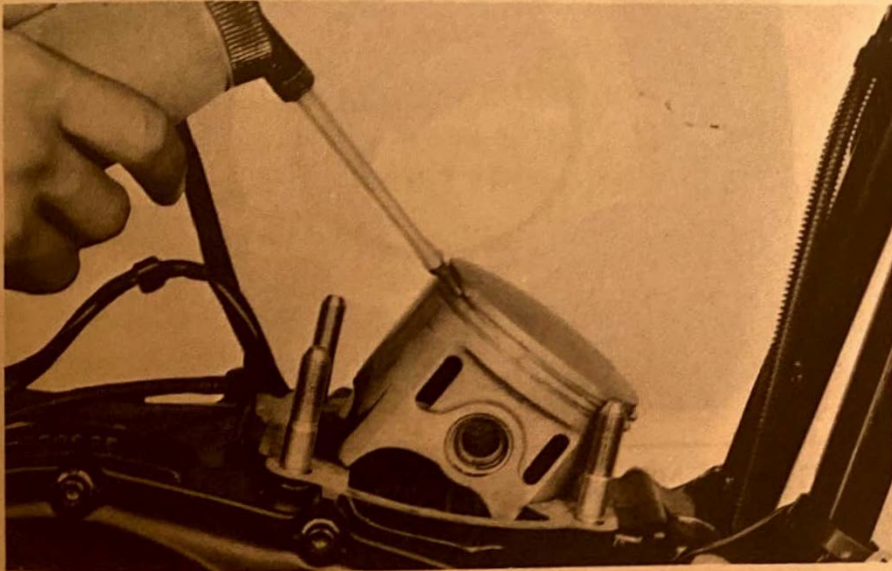

[www.legends-yamaha-enduros.com](http://www.legends-yamaha-enduros.com)

- g. Install new wrist pin circlips and make sure they are fully seated within their grooves.
- h. Take care during installation to avoid damaging the piston skirts against the crankcase as the cylinder is installed. Note the arrow on piston dome must face forward.

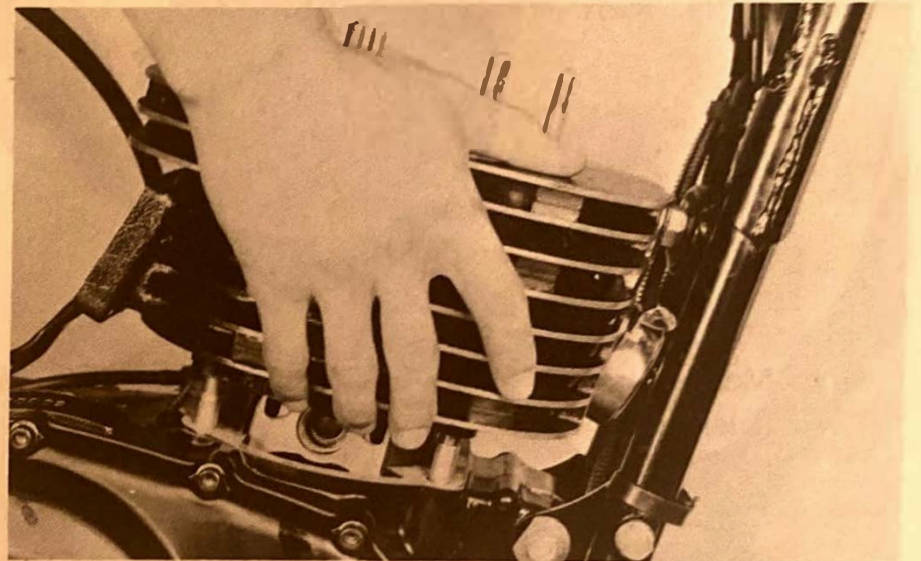

- i. Make sure the rings are properly seated as the cylinder is installed.

## 7. MAINTENANCE - PISTON RINGS

a. Remove ring from piston.



b. Measure ring end gap in free position. If beyond tolerance, replace.

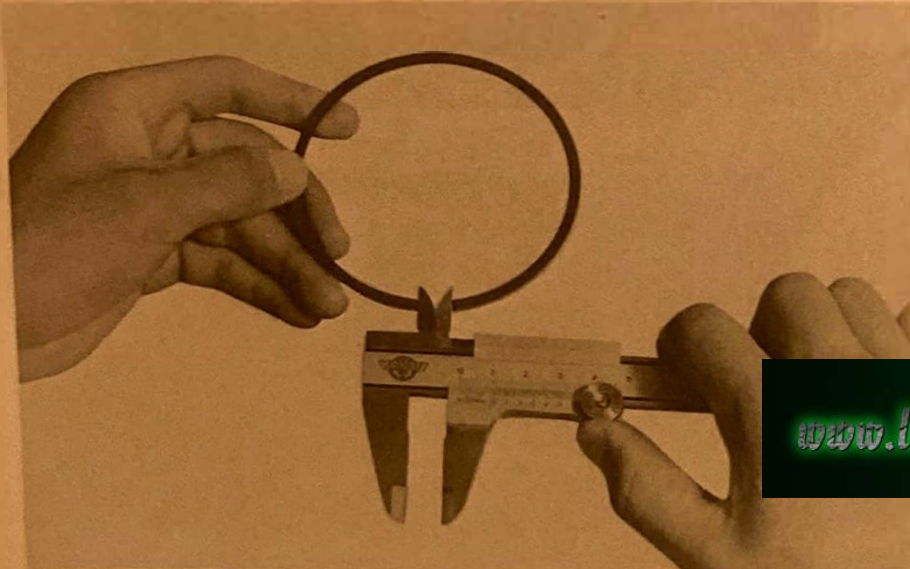

RING END GAP, FREE: 0.394 in. (10 mm.)

c. Insert ring into cylinder. Push down approximately 3/4" using piston crown to maintain right-angle to bore. Measure installed end gap. If beyond tolerance, replace.

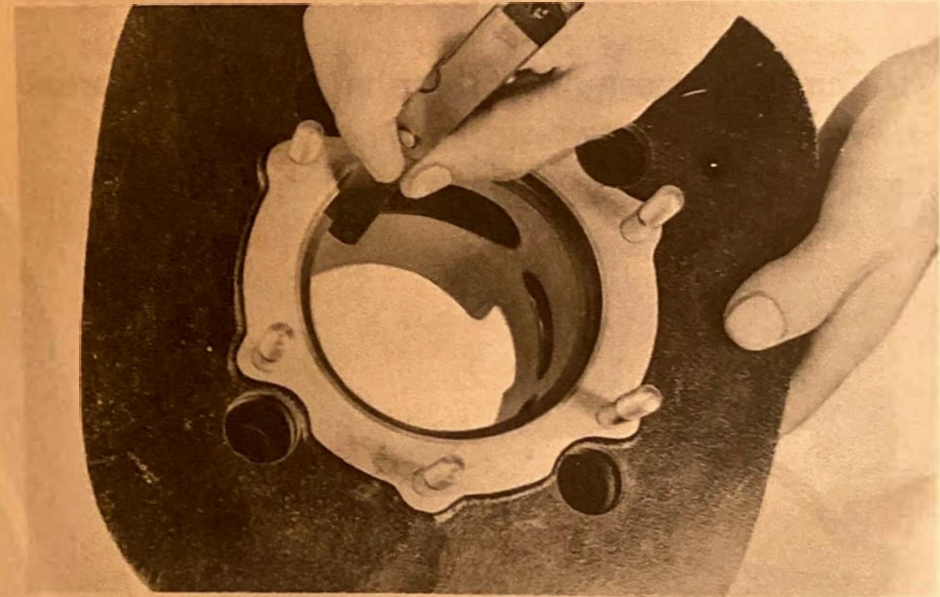

RING END GAP INSTALLED:  
0.016 - 0.020 in. (0.4 - 0.5 mm.)

[www.legends-yamaha-enduros.com](http://www.legends-yamaha-enduros.com)

- d. Holding cylinder towards light, check for full seating of ring around bore. If not fully seated, check cylinder. If cylinder not out-of-round, replace it.
- e. During installation, make sure ring ends are properly fitted around ring locating pin in piston groove. Apply liberal coating of two-stroke oil to ring

**NOTE**

New ring requires break-in. Follow first portion of new machine break-in procedure.

## 8. MAINTENANCE - WRIST PIN, BEARING AND CONNECTING ROD

- a. Check the pin for signs of wear. If any wear is evident, replace pin and bearing.
- b. Check the pin and bearing for signs of heat discoloration. If excessive (heavily blued), replace both.
- c. Check the bearing cage for excessive wear. Check the rollers for signs of flat spots. If found, replace pin and bearing.
- d. Apply a light film of oil to pin and bearing surfaces. Install in connecting rod small end.

Check for play. There should be no noticeable vertical play. If play exists, check connecting rod small end diameter and wear. Replace pin and bearing or all as required.

- e. Mount the dial gauge at right angles to the connecting rod small end holding the bottom of rod toward the dial indicator, rock top of rod and measure axial play.

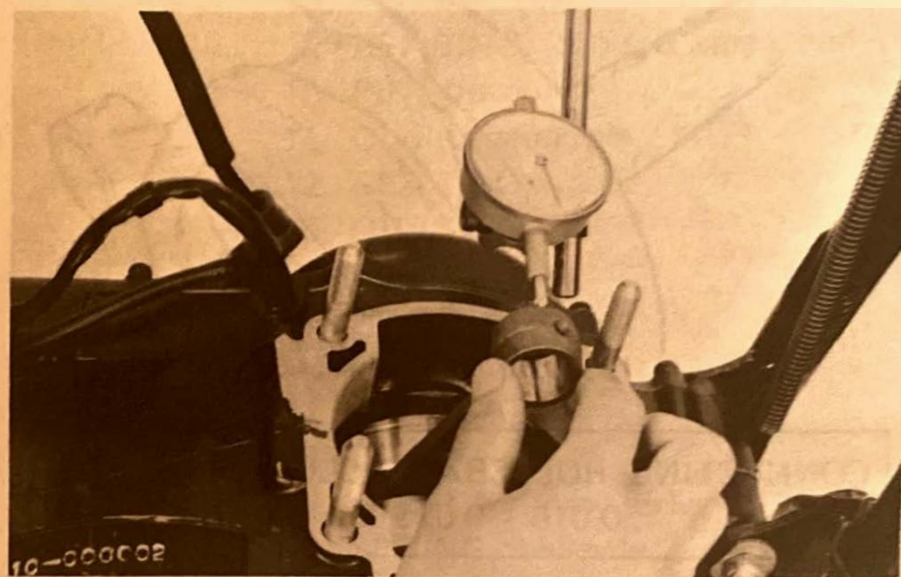

**CONNECTING ROD AXIAL PLAY:**  
0.031 - 0.079 in. (0.8 - 2.0 mm.)

- f. Remove the dial gauge and slide the connecting rod to one side. Insert a feeler gauge between the side of the connecting rod big end and the crank wheel. Measure clearance.

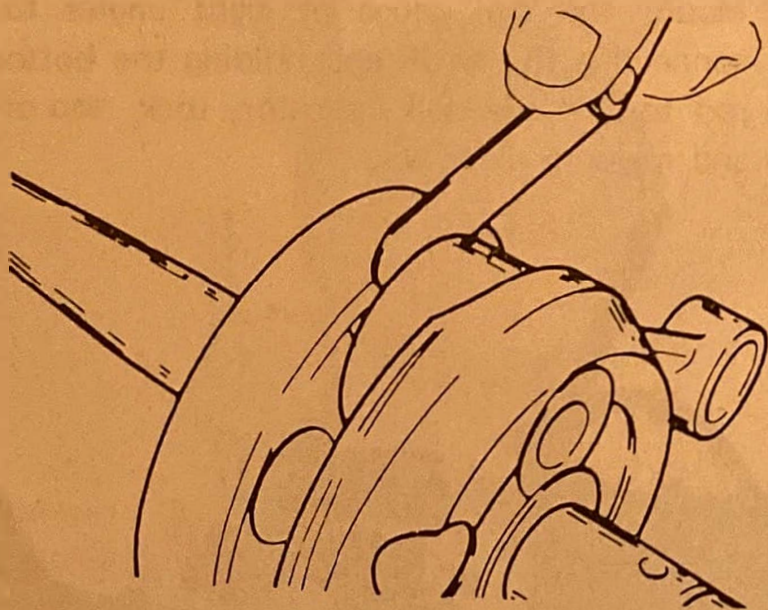

CONNECTING ROD/CRANK CLEARANCE:  
0.016 - 0.020 in. (0.4 - 0.5 mm.)

- g. If any of the above measurements exceed tolerance, crankshaft repair is required. Take the machine to your Authorized Dealer.
- h. During reassembly, apply a liberal coating of two-stroke oil to the wrist pin and bearing. Apply

several drops of oil to the connecting rod big end. Apply several drops of oil into each crankshaft bearing oil delivery hole.

[www.legends-yamaha-enduros.com](http://www.legends-yamaha-enduros.com)

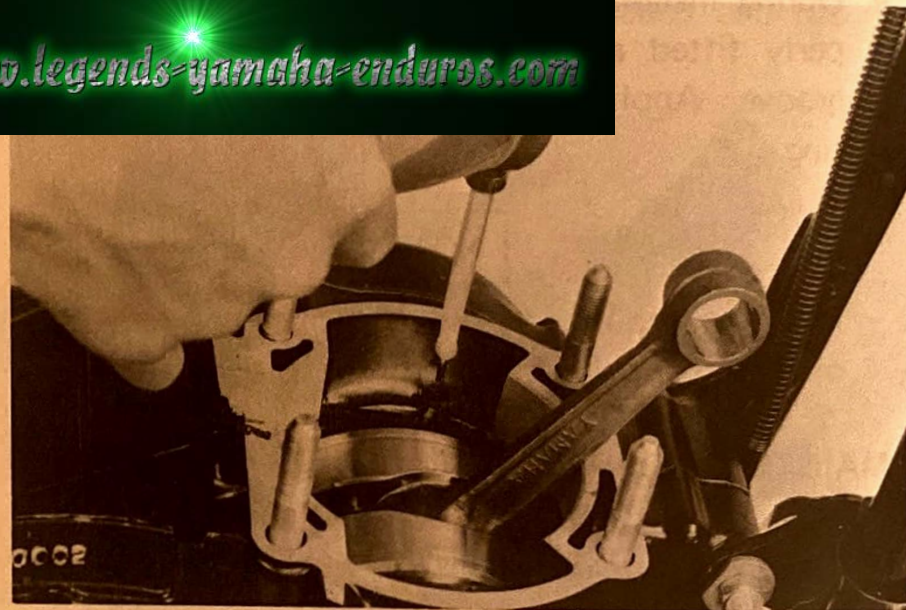

## 9. TROUBLESHOOTING - TOP END AND MUFFLER

The following procedure will indicate if top end disassembly is required.

- Make a spark plug reading. Adjust spark plug and or carburetion as required.
- Decarbonize muffler/spark arrester assembly. Remove cylinder head and make thorough visual inspection. Decarbonize cylinder head and piston crown. Take care that carbon does not drop into crankcase cavity or foul ring grooves. Reassemble.

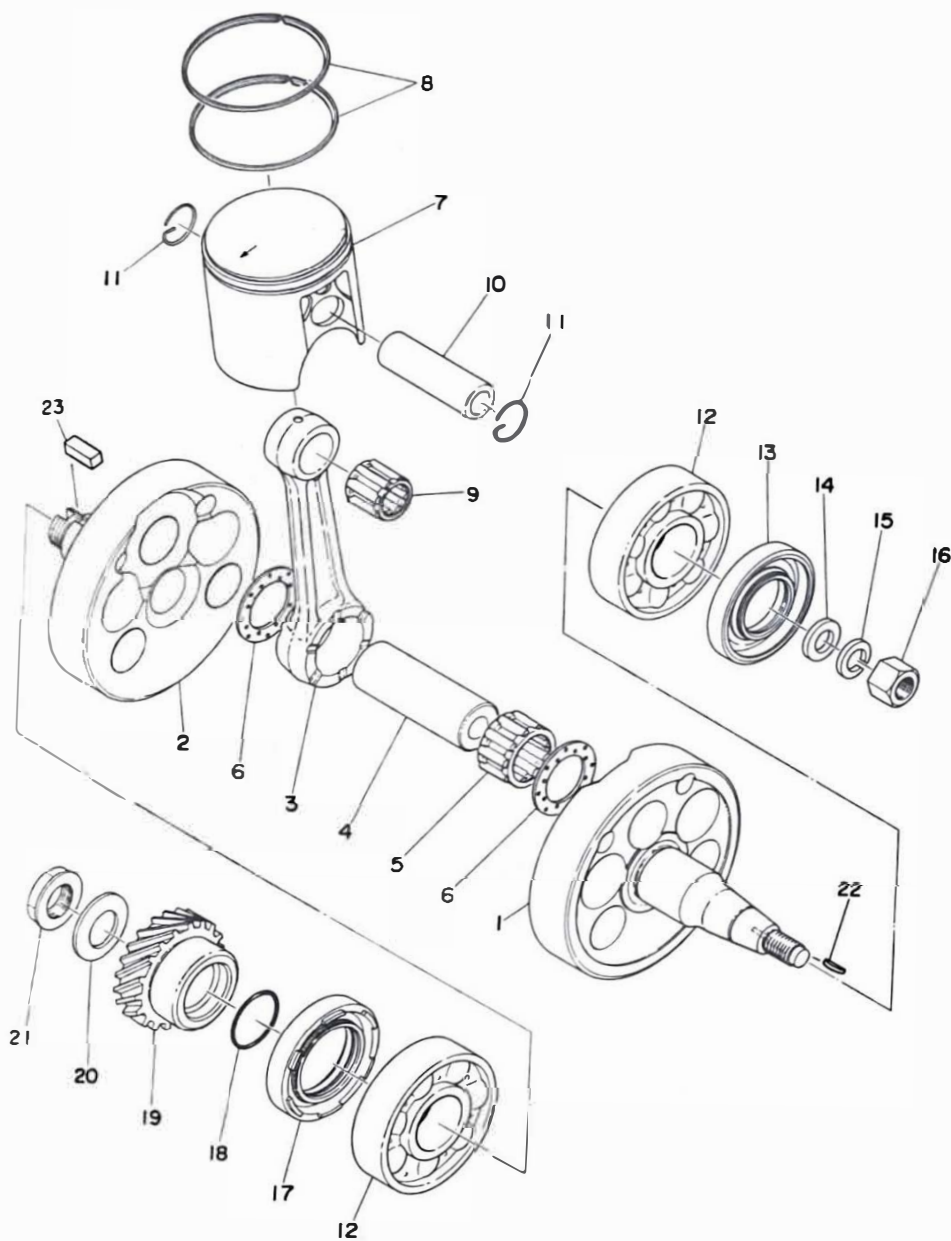

## CRANK - PISTON

1. CRANK, left
2. CRANK, right
3. ROD, connecting
4. PIN, crank
5. BEARING, con-rod big end
6. WASHER, crank pin
7. PISTON
8. PISTON, ring
9. BEARING, con-rod small end
10. PIN, piston
11. CLIP, piston pin
12. BEARING
13. OIL SEAL
14. WASHER 1
15. WASHER, spring
16. NUT, crank shaft
17. OIL SEAL
18. O-RING
19. GEAR, primary drive
20. SPRING, Belleville
21. NUT
22. KEY, woodruff
23. KEY, straight

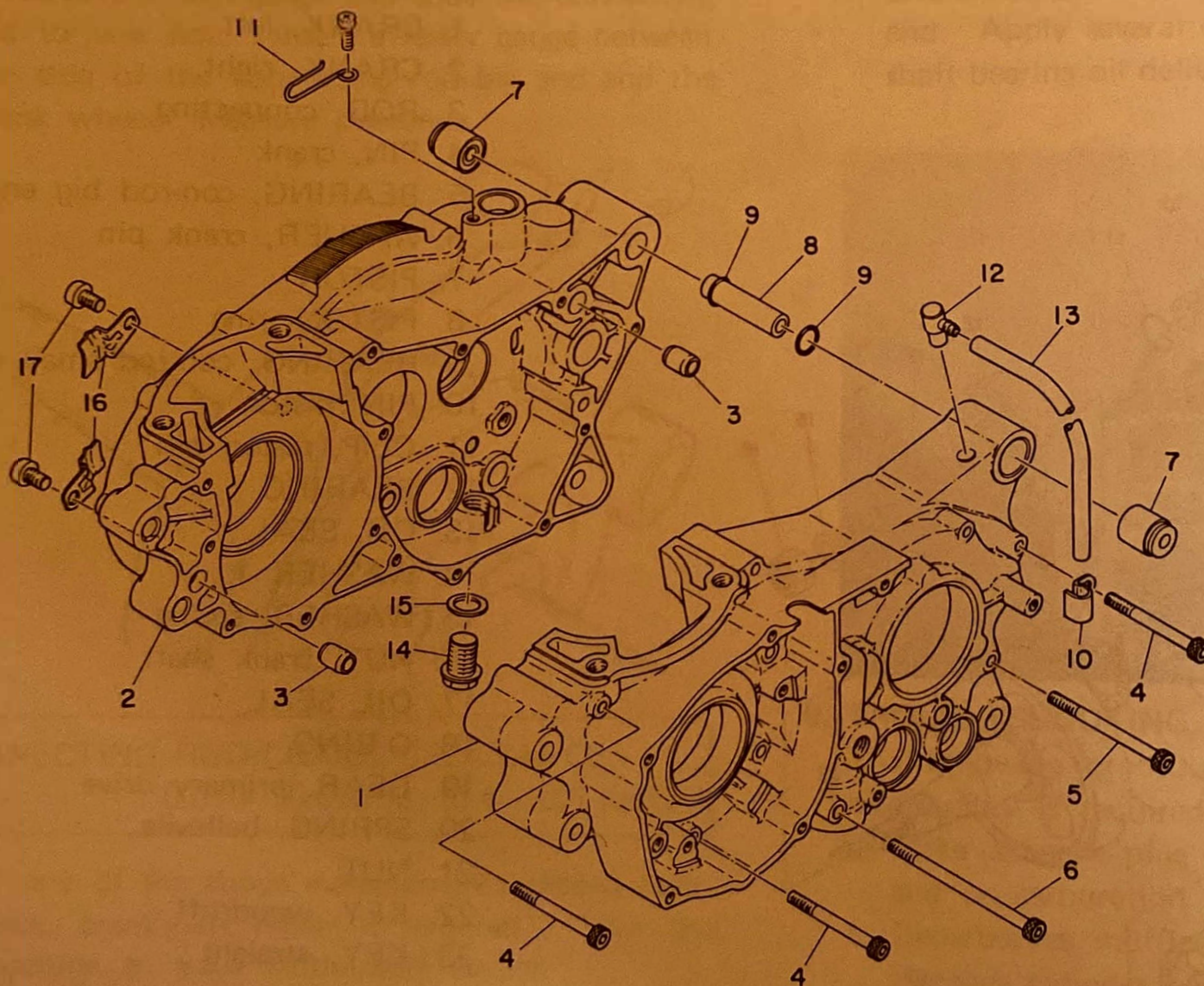

## CRANKCASE

1. CASE, crank left
2. CASE, crank right
3. PIN, dowel
4. BOLT
5. BOLT
6. BOLT
7. DAMPER, engine mounting
8. SPACER, engine mounting
9. O-RING
10. CLAMP
11. CLAMP
12. BREATHER
13. PIPE, breather
14. PLUG, drain
15. GASKET, drain plug
16. HOLDER
17. SCREW, panhead

## SECTION D. IGNITION

C.D.I. Ignition Requires No Periodic Maintenance

### 1. LOCATION OF COMPONENTS

The system consists of a magneto, a coil and a C.D.I. unit. The magneto is located behind the case on the left side of the engine. The C.D.I. unit is installed on the front of the steering head, and the ignition coil is mounted on the frame right above the air filter.

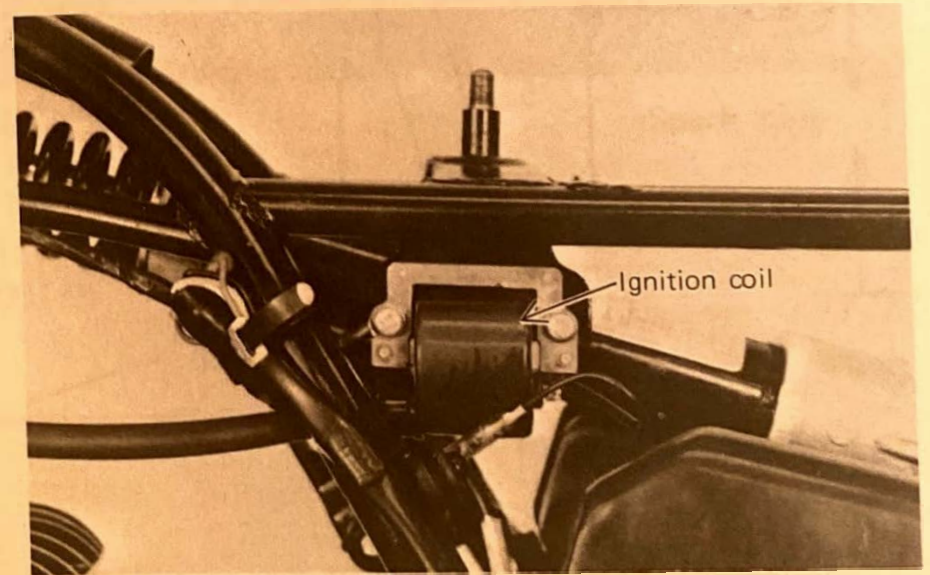
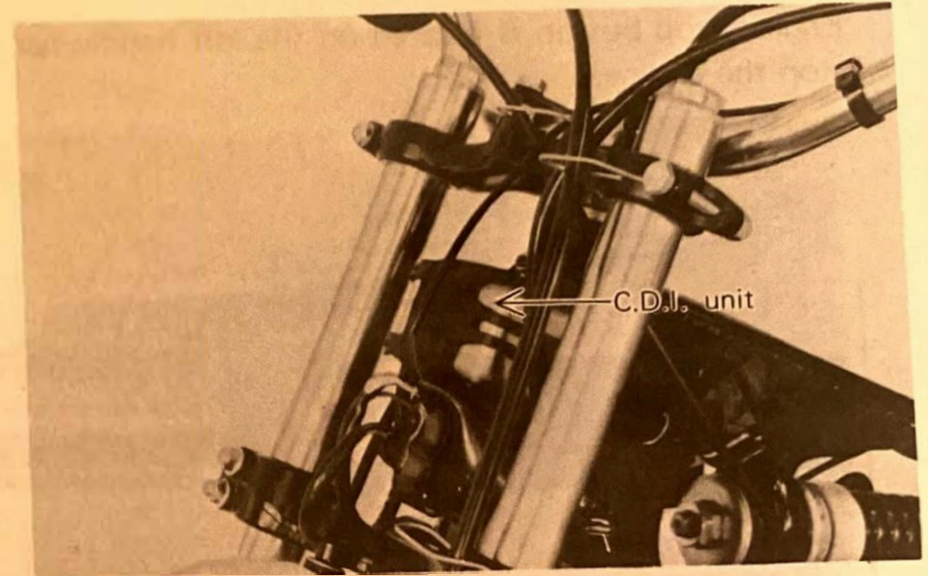
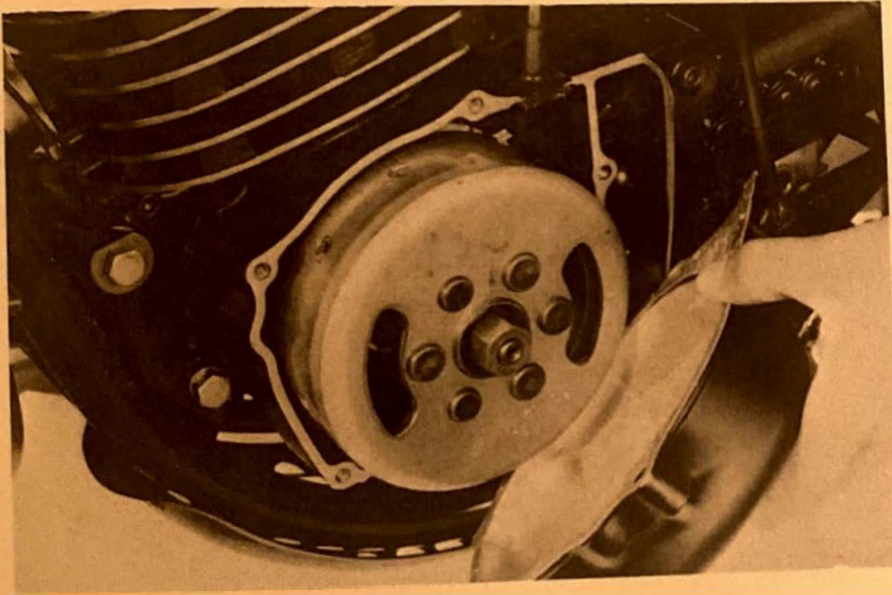



Engine stop button is located on the left handle bar to stop the engine.

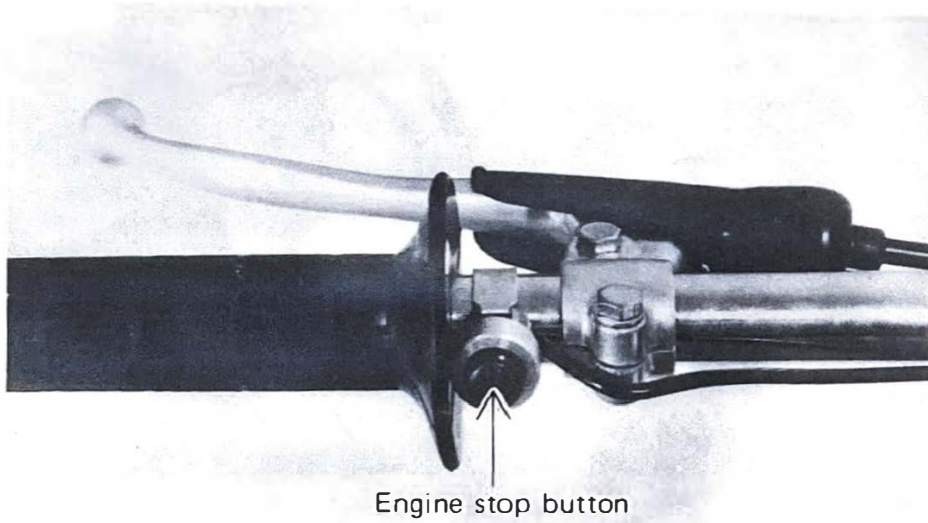

## 2. TROUBLESHOOTING

- a. Check for spark at spark plug — if no spark, check connectors.
- b. If connections are clean and tight, refer to Mechanical Adjustments, Ignition Timing. Ensure that the timing is correct.

Any further troubleshooting of the C.D.I. system must be performed by your Yamaha Dealer.

### 3. WIRING DIAGRAM

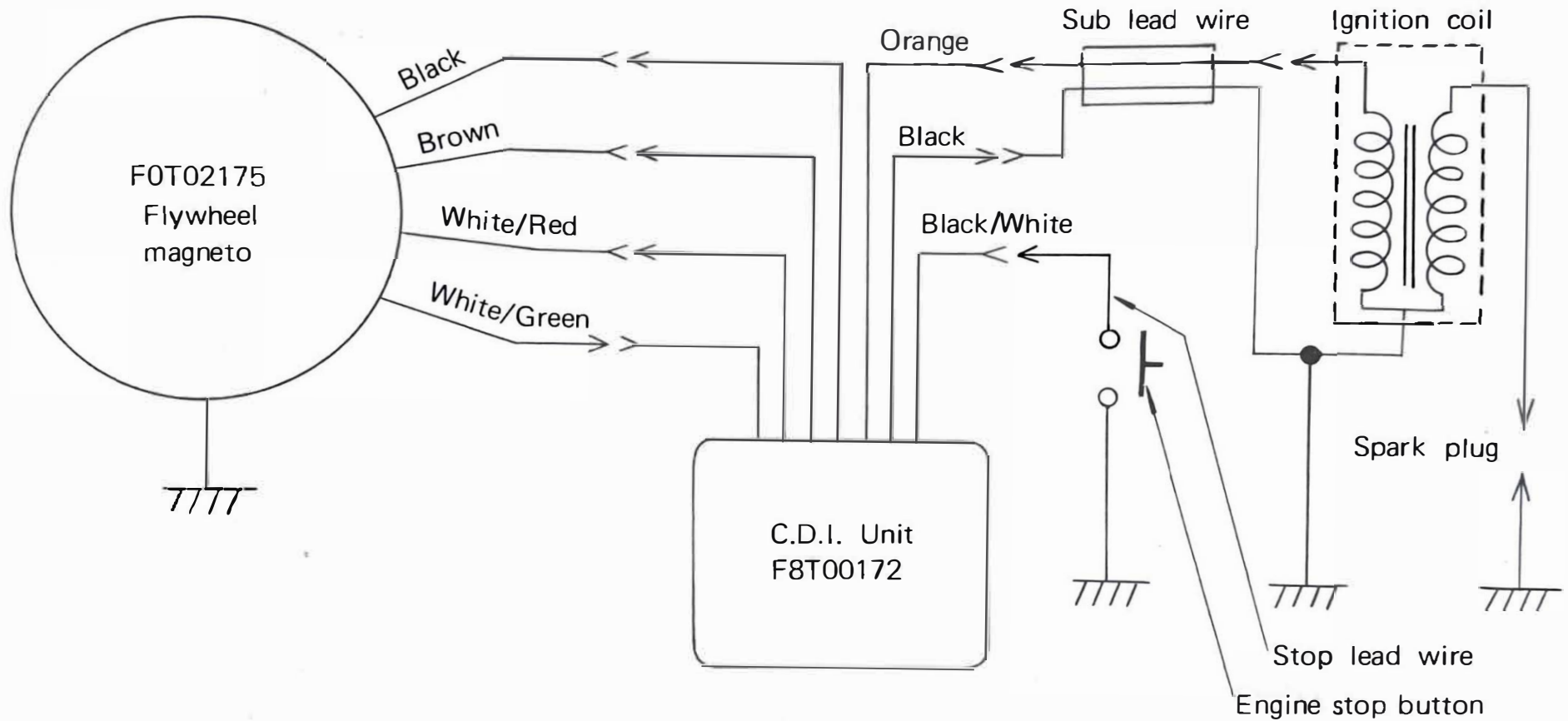

## SECTION E. KICK STARTER, CLUTCH, SHIFTER AND TRANSMISSION

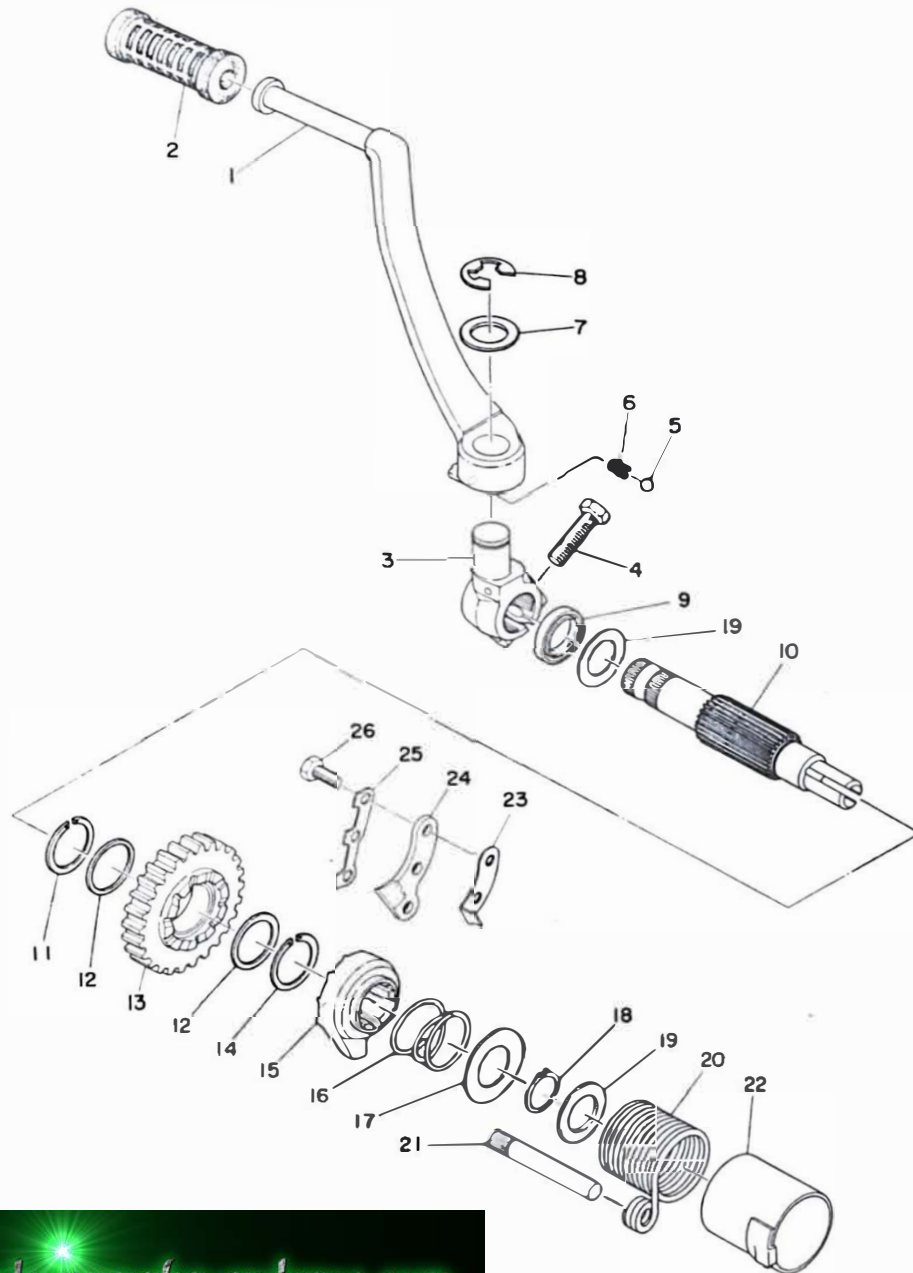

### KICK STARTER MECHANISM

1. CRANK, kick
2. COVER, kick lever
3. BOSS, kick crank
4. BOLT
5. BALL
6. SPRING, boss stopper
7. WASHER, plate
8. CIRCLIP
9. OIL SEAL
10. AXLE, kick
11. CIRCLIP
12. WASHER, gear hold
13. GEAR KICK
14. CIRCLIP
15. WHEEL, ratchet
16. SPRING, ratchet wheel
17. COVER, spring
18. CIRCLIP
19. WASHER, gear hold
20. SPRING, kick
21. STOPPER, kick spring
22. GUIDE, spring
23. STOPPER
24. GUIDE, spring
25. WASHER, lock
26. BOLT

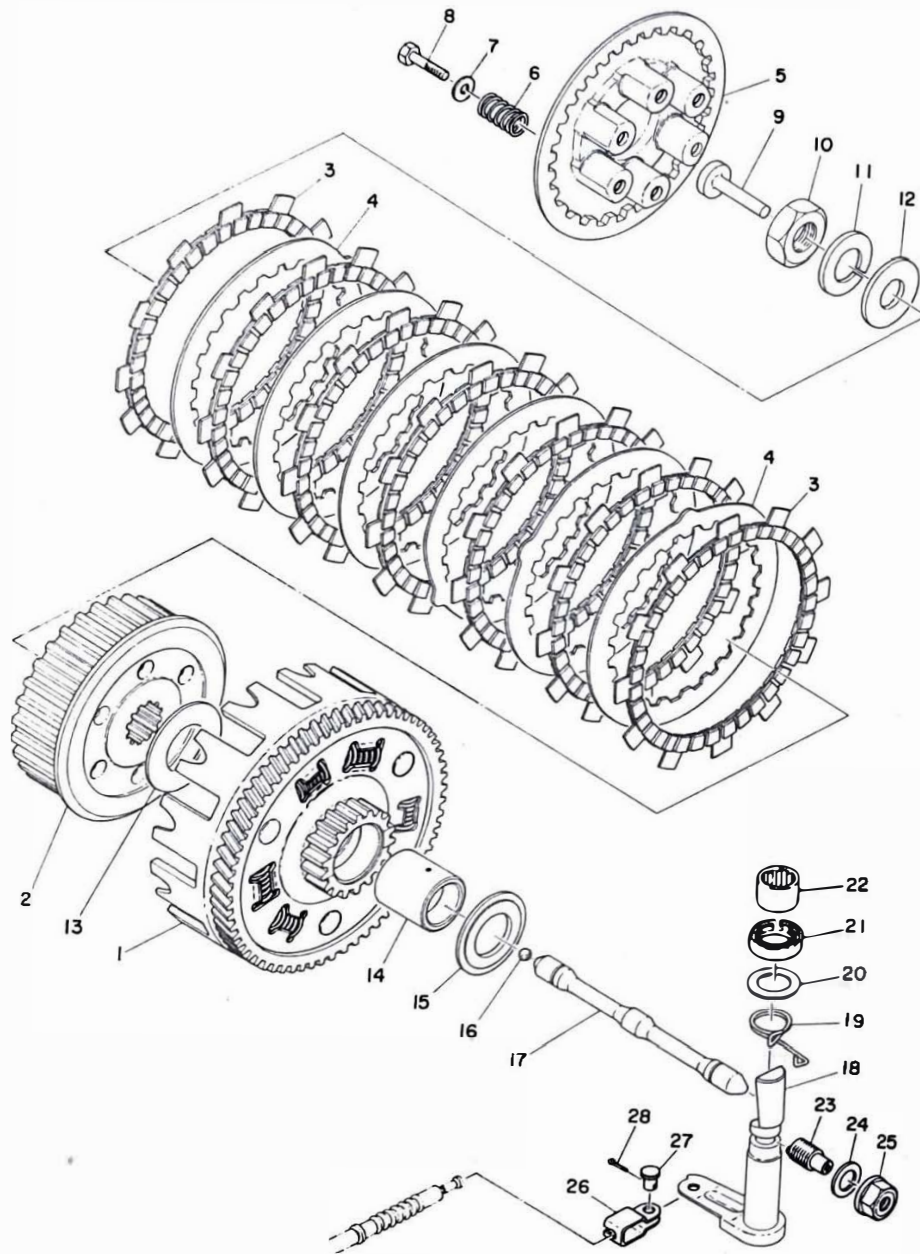

## CLUTCH MECHANISM

1. PRIMARY DRIVEN GEAR COMP
2. BOSS, clutch
3. PLATE, friction
4. PLATE, clutch
5. PLATE, pressure
6. SPRING, clutch
7. WASHER, plate
8. SCREW, crossrecess hexagon
9. ROD, push
10. NUT, lock
11. WASHER, spring
12. WASHER, plain
13. PLATE, thrust 2
14. SPACER
15. PLATE, thrust 1
16. BALL
17. ROD, push
18. AXLE, push lever
19. SPRING, return
20. WASHER, plate
21. OIL SEAL
22. BEARING
23. SCREW, adjusting
24. GASKET
25. NUT, adjusting
26. JOINT
27. PIN
28. PIN, cotter

**NOTE**

Clutch adjustment is covered in Chapter IV, "Mechanical Adjustments."

**1. KICK STARTER REMOVAL**

- a. Remove the kick starter lever.

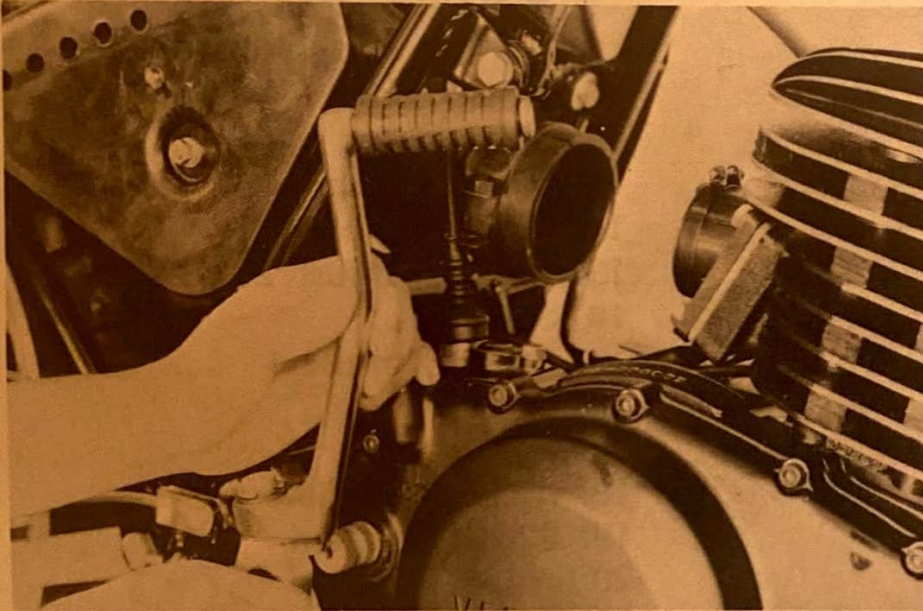

- b. Remove the foot peg retaining bolts and remove the foot peg.

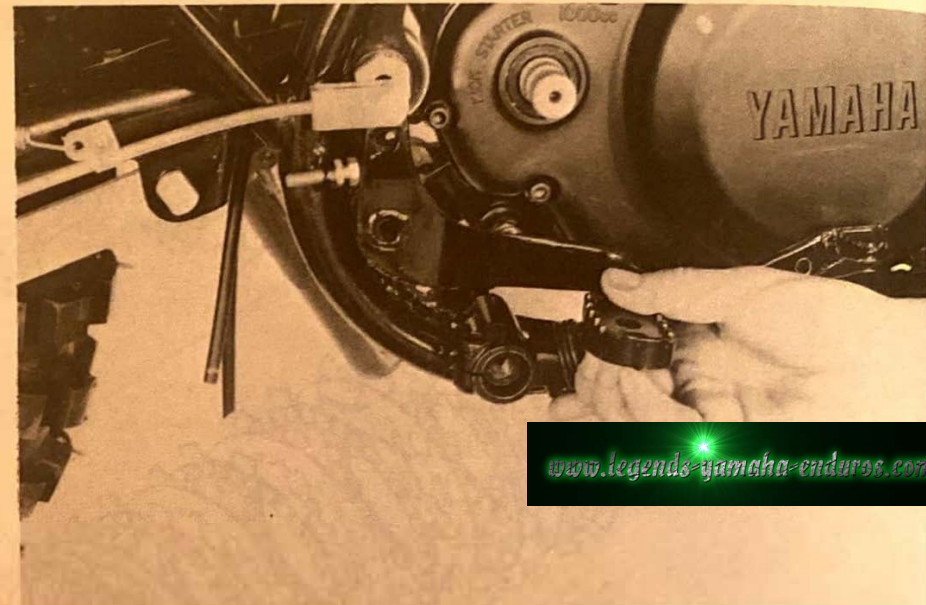

- c. Remove the brake lever circlip and remove the brake lever.

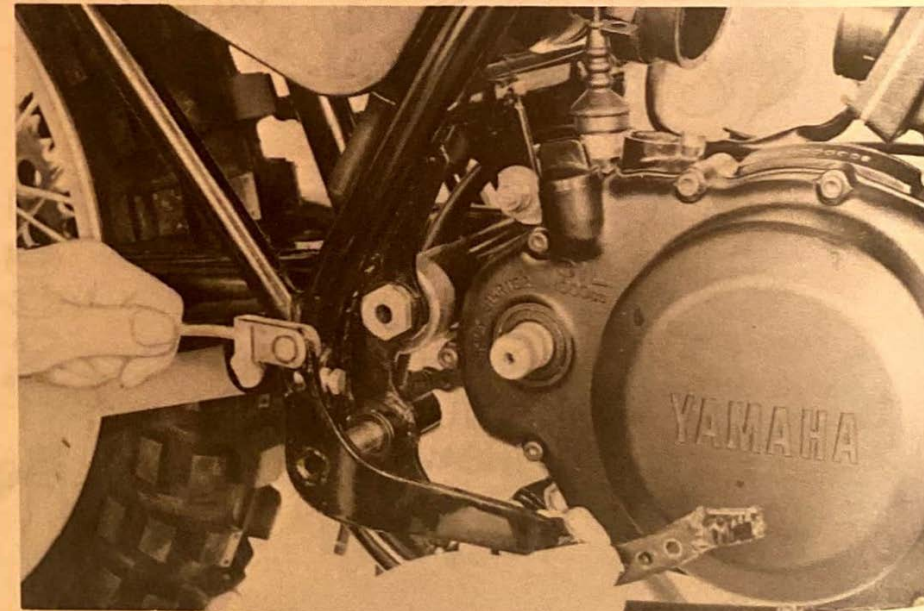

d. Remove the Allen bolts holding the side cover in place and remove the cover.

Note the position of the dowel pins and location of kick starter axle shim.

## 2. CLUTCH REMOVAL

a. Repeat steps "a" through "d" under Kick Starter Removal.

b. Remove the Phillips screws (6) holding the pressure plate. Remove the clutch springs, pressure plate and push rod. Remove the clutch plates and friction plates.

### NOTE

When removing Phillips spring screws, loosen each screw in several stages working in a cross-hatch pattern to avoid any unnecessary warpage. Note the condition of each piece as it is removed and its location with the assembly.

[www.legends-yamaha-enduros.com](http://www.legends-yamaha-enduros.com)

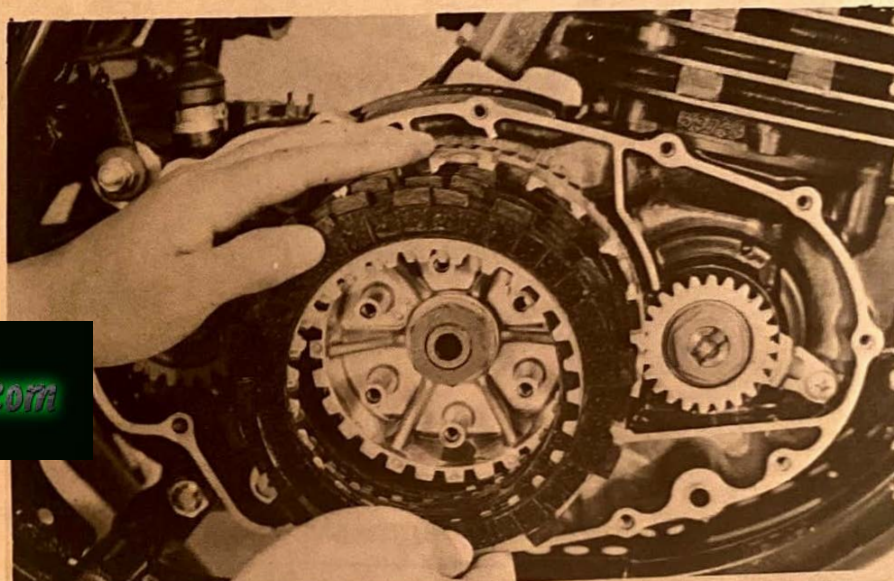
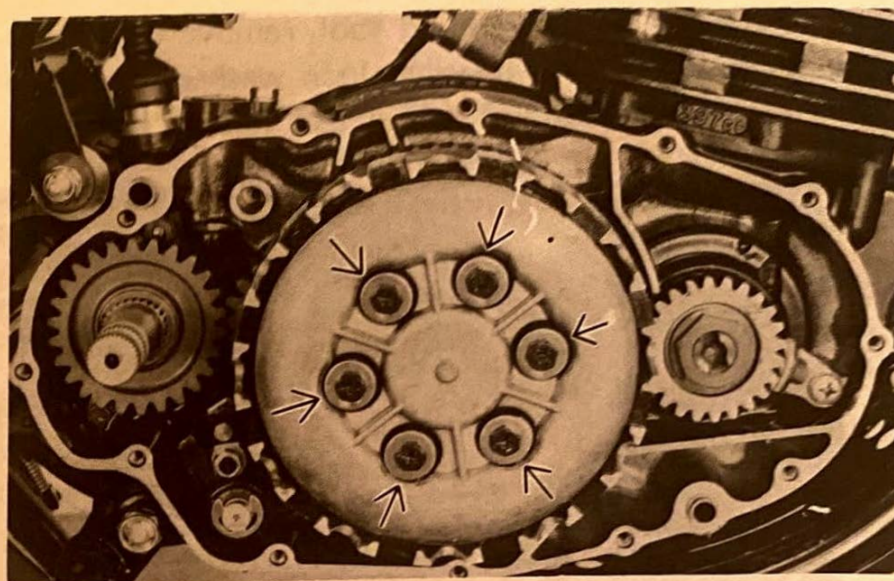

- c. Using the clutch holding tool, remove the clutch securing nut and bevelled lock washer. Remove the clutch boss and driven gear (clutch housing).

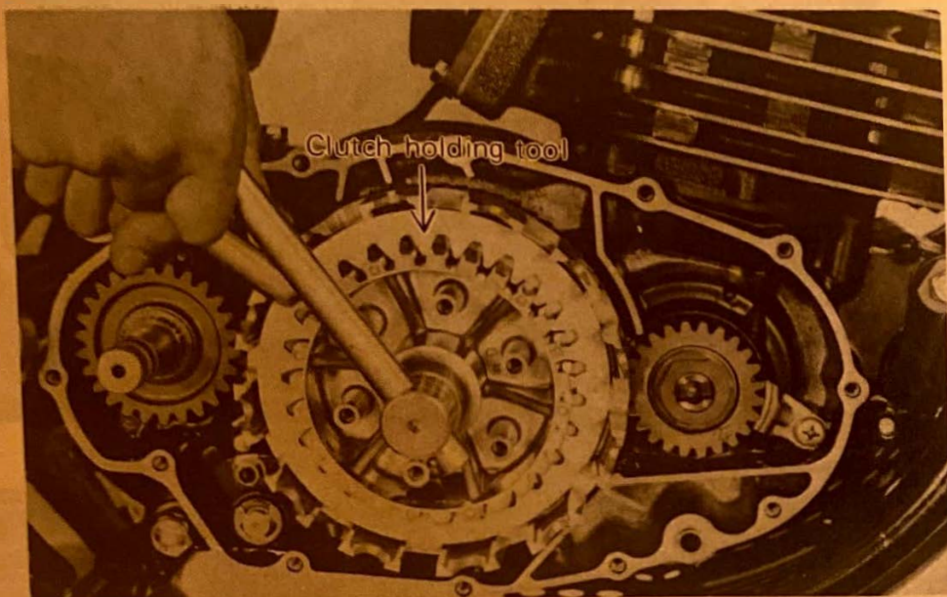

- d. If the clutch housing spacer remains on the transmission main shaft, remove it. Remove the thrust plate and thrust plate spacers.  
e. Install kick crank on kick axle. Rotate kick axle counterclockwise approximately 1/8 turn and pull straight out.

**NOTE**

Decompression wire must be removed, prior to remove kick axle.

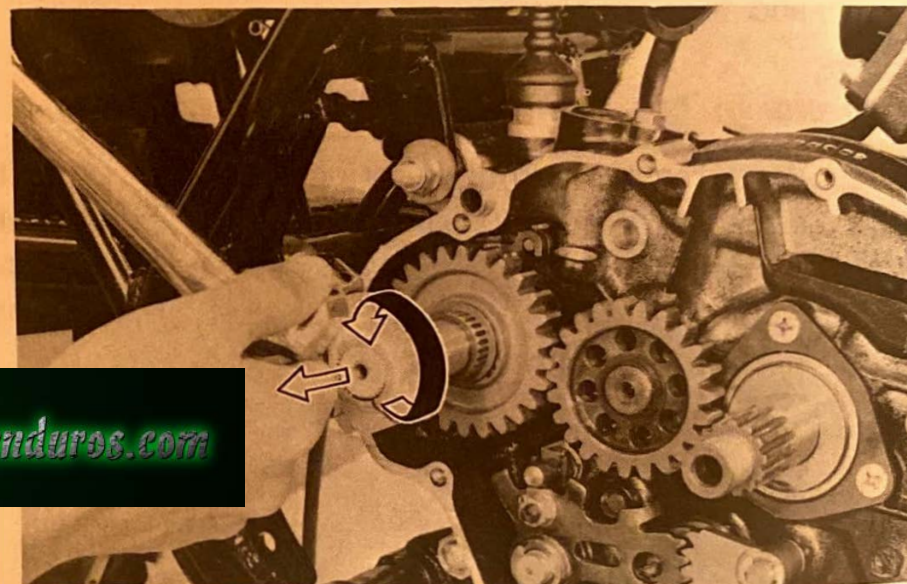

[www.legends-yamaha-enduros.com](http://www.legends-yamaha-enduros.com)

### 3. TROUBLESHOOTING - CLUTCH ASSEMBLY

- a. Measure the friction plates at three or four points. If their minimum thickness exceeds tolerance, replace.

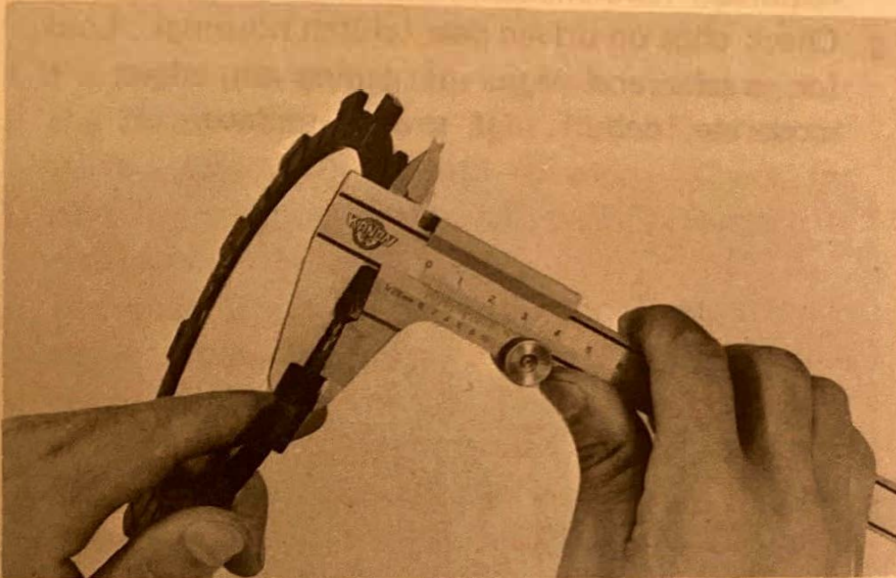

FRICITION PLATE THICKNESS:  
0.118 in. (3 mm.)

- b. Check the plates for signs of warpage and heat damage, replace as required.

#### NOTE

For optimum performance, if any plate requires replacement, it is advisable to replace the entire set.

- c. Check each clutch plate for signs of heat damage and warpage. Place on surface plate (plate glass is acceptable) and use feeler gauge.



CLUTCH PLATE WARP ALLOWANCE:  
Maximum: 0.002 in. (0.05 mm.)



- d. Thoroughly clean the clutch housing and spacer. Apply a light film of oil on the bushing surface and spacer. Fit the spacer into the bushing. It should be a smooth, thumb-press fit. The spacer should rotate smoothly within the bushing. If appropriate measuring devices are available, measure the minimum I.D. of the clutch housing and the maximum O.D. of the bushing spacer. If beyond tolerance, have dealer replace bushing and refit.
- e. Check the bushing and spacer for signs of galling, heat damage, etc. If severe, replace as required.

- f. Apply thin coat of oil on transmission main shaft and bushing spacer I.D. Slip spacer over main shaft. Spacer should fit with approximately same "feel" as in clutch housing. Replace as required. See measurement tolerances.
- g. Check dogs on driven gear (clutch housing). Look for cracks and signs of galling on edges. If moderate, deburr. If severe, replace.

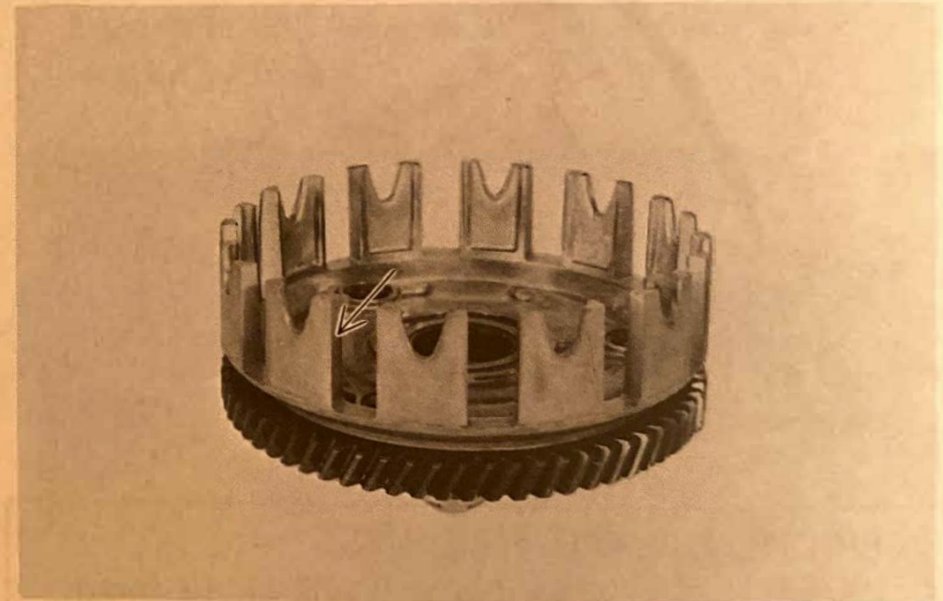
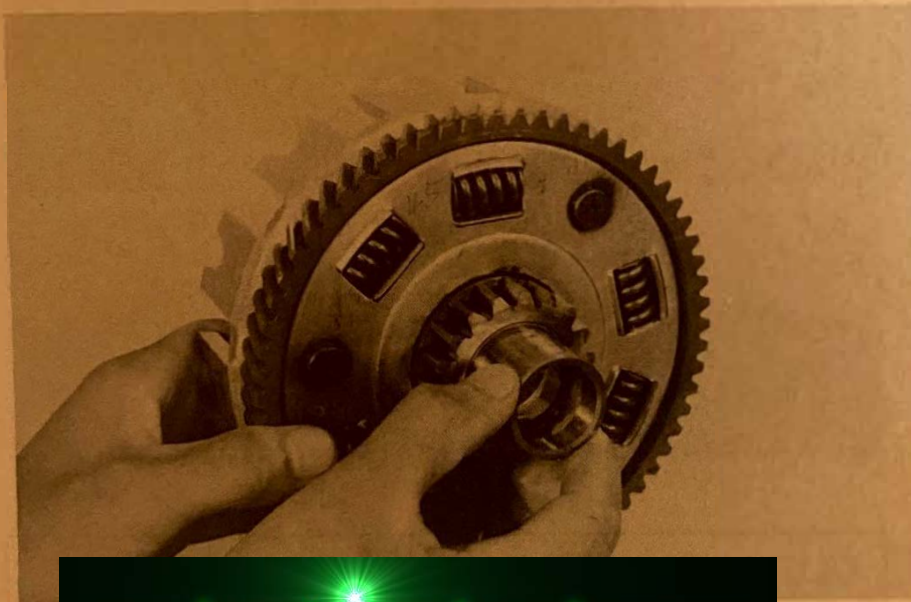

- h. Check splines on clutch boss for signs of galling. If moderate, deburr. If severe, replace.

[www.legends-yamaha-enduros.com](http://www.legends-yamaha-enduros.com)

**NOTE**

Galling on either the friction plate dogs of the clutch housing or clutch plate splines of the clutch boss will cause erratic clutch operation.

- i. Fit the clutch thrust bearing (two pieces) against the thrust plate with a light film of oil on all parts. Check for smooth rotation. Check for signs of excessive wear, all parts. Replace as necessary.
- j. If clutch operation has been abnormal, and the above procedures show no major failures, install the clutch housing on the transmission main shaft with thrust plates, bearing spacer, and clutch boss in their proper positions for reassembly. Do not install clutch or friction plates. Install bevelled lock washer and clutch securing nut. Torque to standard assembly value.
- k. With transmission in neutral, primary driven gear stationary, clutch boss should turn without excessive drag within the clutch housing. If housing does not turn easily, indicating insufficient housing end play, check thrust plates and thrust bearing for incorrect thickness. Correct by installing thinner thrust plates. Clutch housing end play is given in table and can be measured with a dial gauge.

- l. Measure each clutch spring. If beyond tolerance, replace.

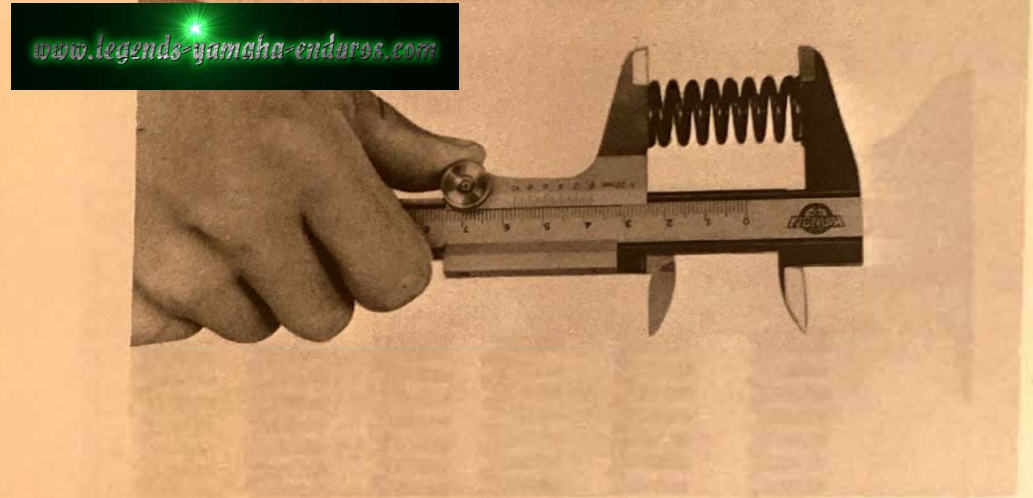

**CLUTCH SPRING FREE LENGTH:**

1.626 ins. (41.3 mm.)

**NOTE**

For optimum clutch operation it is advisable to replace the clutch springs as a set if one or more are faulty.

- m. Stack the clutch spring set on a level surface. Rotate each spring until all are at approximately the same vertical angle and maximum apparent height. Place straight edge across set. If any spring exceeds tolerance, replace that spring.

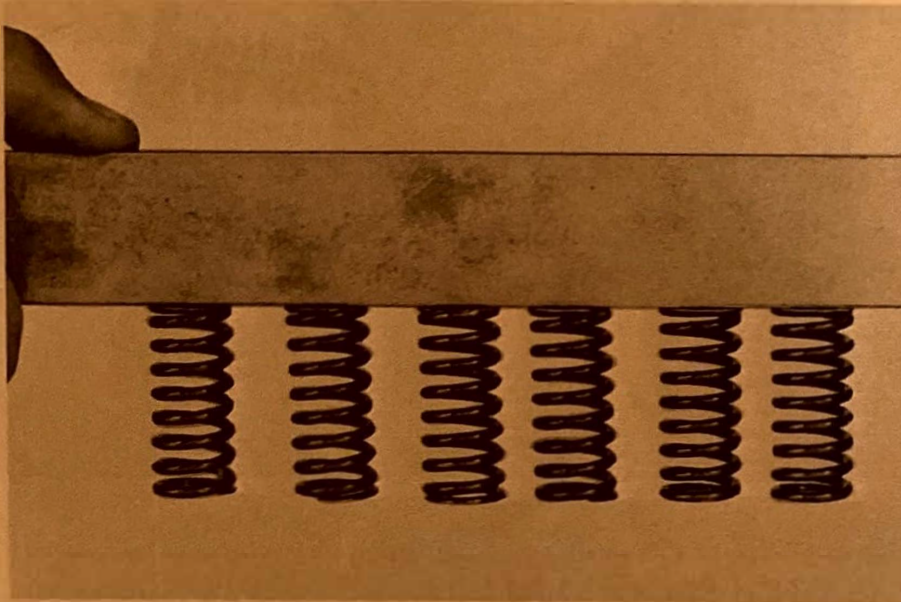

- n. Take care that the thrust plates and thrust bearing do not slip out of position as the housing and clutch boss are installed. Install all parts with a heavy coat of 10W-30 motor oil on their mating surfaces.

[www.legends-yamaha-enduros.com](http://www.legends-yamaha-enduros.com)

#### 4. SHIFT MECHANISM

##### NOTE

Shifter maintenance and adjustment should be performed with clutch assembly removed.

- In 2nd gear, check for proper centering. Change adjustment on screw as required.
- With the change pedal in place on the change shaft, push down then up. There should be no freeplay. If evident, the shift return spring is fatigued, replace.
- Check the return spring for change levers 2 and 3. If it will not hold change lever 3 firmly against the shift cam dowel pins, replace.

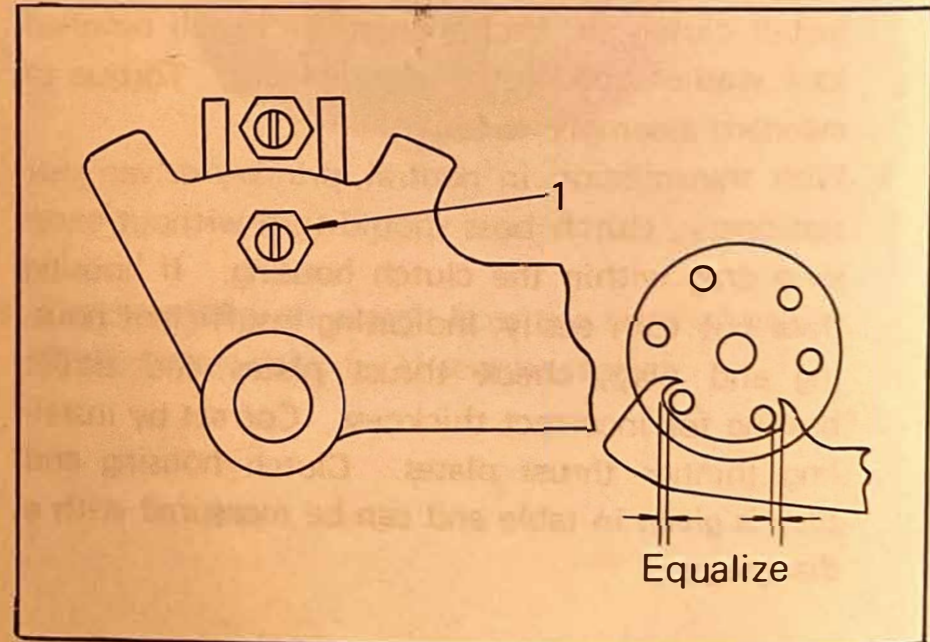

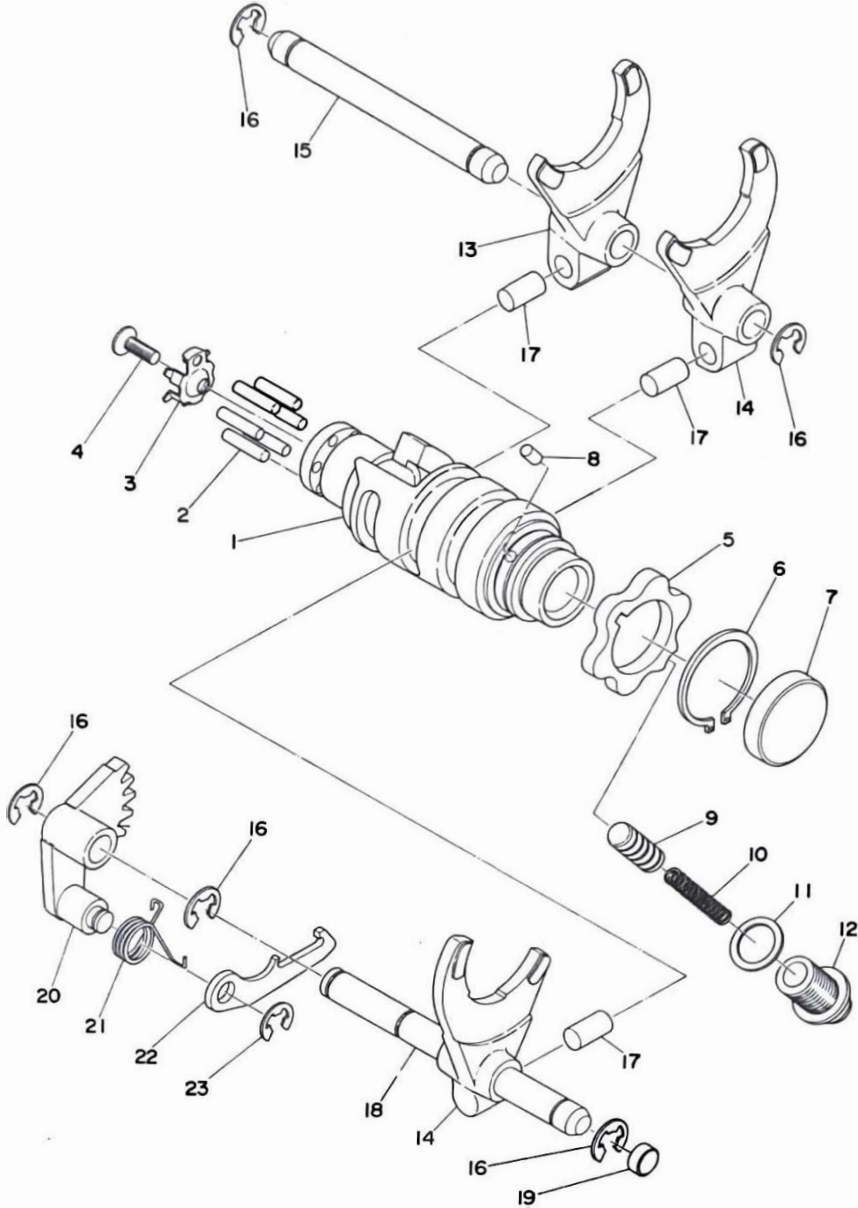

## SHIFTER 1

1. CAM, shift
2. PIN, dowel
3. PLATE, side
4. SCREW, flathead
5. PLATE, stopper
6. CIRCLIP
7. PLUG, blind
8. PIN, dowel
9. STOPPER, cam
10. SPRING, cam stopper
11. GASKET, drain plug
12. SCREW, spring
13. FORK, shifter 1
14. FORK, shift
15. BAR, shift fork guide 2
16. CIRCLIP
17. PIN, cam follower
18. BAR, shift fork guide 1
19. PLUG, blind
20. LEVER, change 2
21. SPRING, torsion
22. LEVER, change 3
23. CIRCLIP

## 5. TRANSMISSION MECHANISM

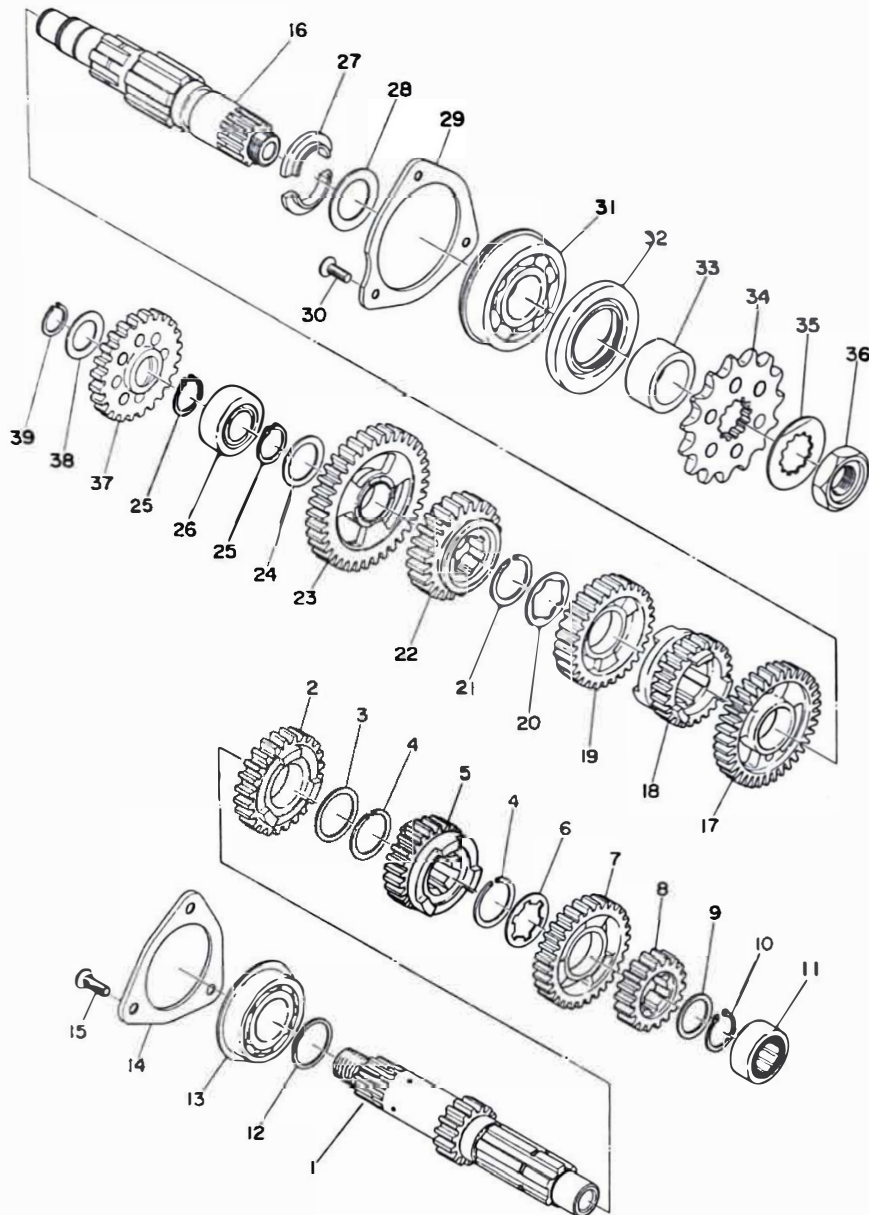

## TRANSMISSION

- |                          |                          |
|--------------------------|--------------------------|
| 1. AXLE, main            | 25. CIRCLIP, gear hold   |
| 2. GEAR, 4th pinion      | 26. BEARING, drive axle  |
| 3. WASHER, gear hold     | 27. SPACER, drive axle   |
| 4. CIRCLIP               | 28. SHIM, drive axle     |
| 5. GEAR, 3rd pinion      | 29. PLATE, bearing cover |
| 6. WASHER, gear hold     | 30. SCREW, flathead      |
| 7. GEAR, 5th pinion      | 31. BEARING              |
| 8. GEAR, 2nd pinion      | 32. OIL SEAL             |
| 9. WASHER, gear hold     | 33. COLLER, distance     |
| 10. CIRCLIP              | 34. SPROCKET, drive      |
| 11. BEARING              | 35. WASHER, lock         |
| 12. SHIM, drive axle     | 36. NUT, lock            |
| 13. BEARING              | 37. GEAR, kick idle      |
| 14. PLATE, bearing cover | 38. WASHER, plate        |
| 15. SCREW, flat head     | 39. CIRCLIP              |
| 16. AXLE, drive          |                          |
| 17. GEAR, 2nd wheel      |                          |
| 18. GEAR, 5th wheel      |                          |
| 19. GEAR, 3rd wheel      |                          |
| 20. WASHER, gear hold    |                          |
| 21. CIRCLIP              |                          |
| 22. GEAR, 4th wheel      |                          |
| 23. GEAR, 1st wheel      |                          |
| 24. WASHER, gear hold    |                          |

## SECTION F. DRIVE SPROCKETS AND CHAIN

### NOTE

Please refer to Maintenance Intervals and Lubrication Intervals charts located in Chapter I for additional information.

#### 1. DRIVE SPROCKET

- a. Using a blunt chisel, flatten the drive sprocket lock washer tab.
- b. With the drive chain in place, transmission in gear, firmly apply the rear brake. Remove the sprocket securing nut. Remove the sprocket.

- c. Check sprocket wear. Replace if wear decreases tooth height to a point approaching the roller center line.

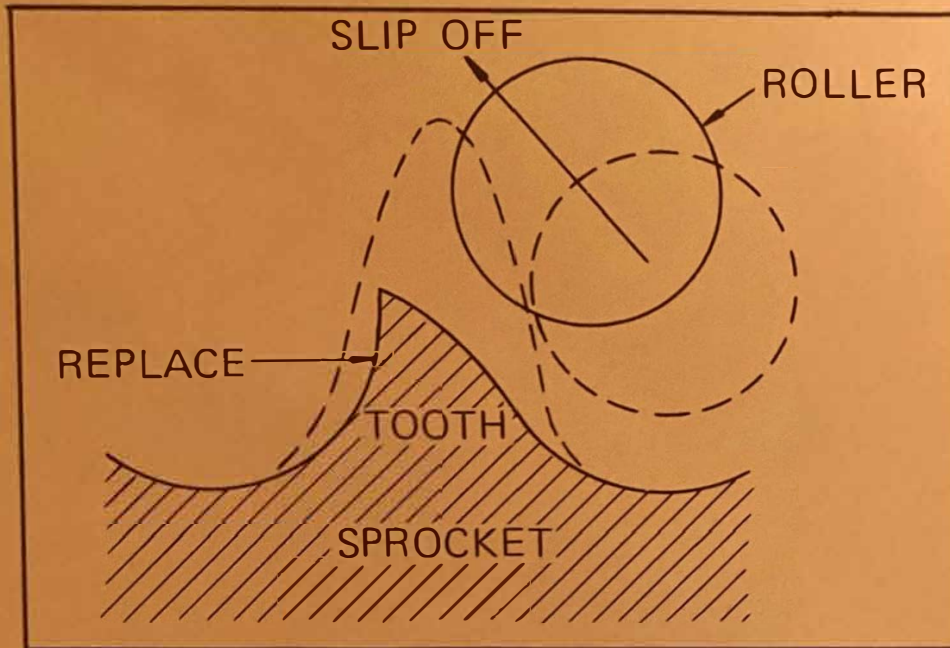

- d. Replace if tooth wear shows a pattern such as that in the illustration, or as precaution and common sense dictate.

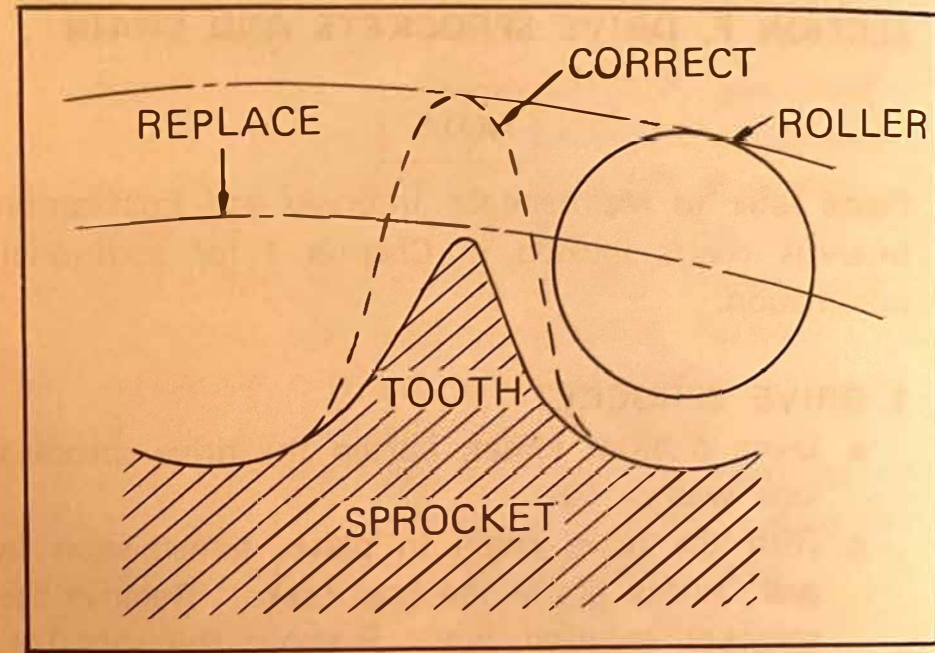

- e. During drive sprocket reassembly, make sure the lock washer splines are properly seated on the drive shaft splines. Tighten securing nut thoroughly to specified torque value. Bend lock washer tab fully against securing nut flats.

DRIVE SPROCKET SECURING NUT TORQUE:  
42 - 51 ft-lbs. (5.8 - 7 m-kgs.)

## 2. DRIVEN SPROCKET

With the rear wheel removed, proceed as follows:

- a. Using a blunt chisel, flatten the securing bolt lock washers tabs. Remove the securing bolts (6). Remove the lock washers and sprocket.
- b. Check sprocket wear per procedures for the drive sprocket.
- c. Check the sprocket to see that it runs true. Do not heat and hammer to straighten. Use a press. If severely bent, replace.
- d. During reassembly, make sure the sprocket and sprocket seat are clean. Tighten the securing bolts in a cross-hatch pattern. Bend the tabs of the lock washers fully against the securing bolt flats.

DRIVEN SPROCKET SECURING BOLT TORQUE: 14.5 ft-lbs. (2.0 m-kgs.)
--

## 3. CHAIN

NOTE

Refer to Maintenance and Lubrication Charts located in Chapter I for additional information.

- a. Using a blunt-nosed pliers, remove the master link clip and side plate. Remove the chain.
- b. Check the chain for stiffness. Hold as illustrated. If stiff, soak in solvent solution, clean with medium bristle brush, dry with high pressure air. Oil chain thoroughly and attempt to work out kinks. If still stiff, replace.

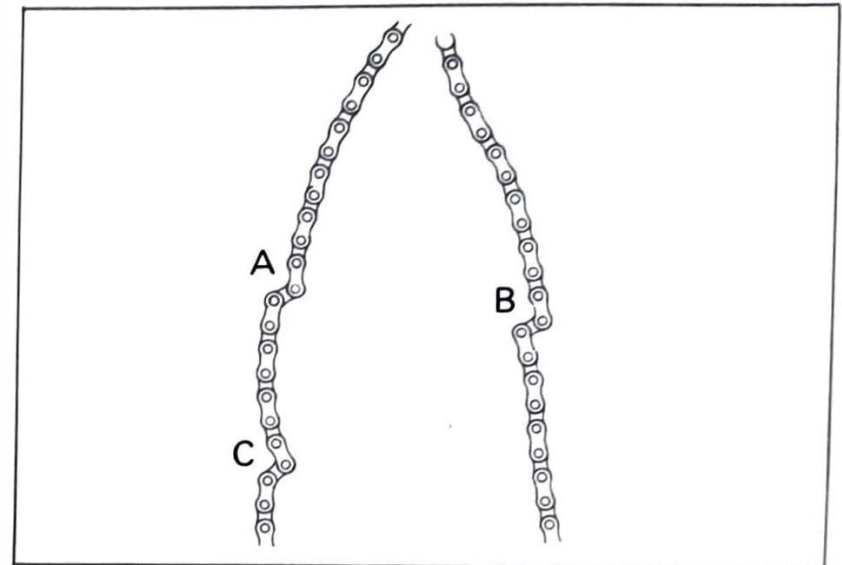



- c. Check the side plates for visible wear. Check to see if excessive play exists in pins and rollers. Check for damaged rollers. Replace as required.

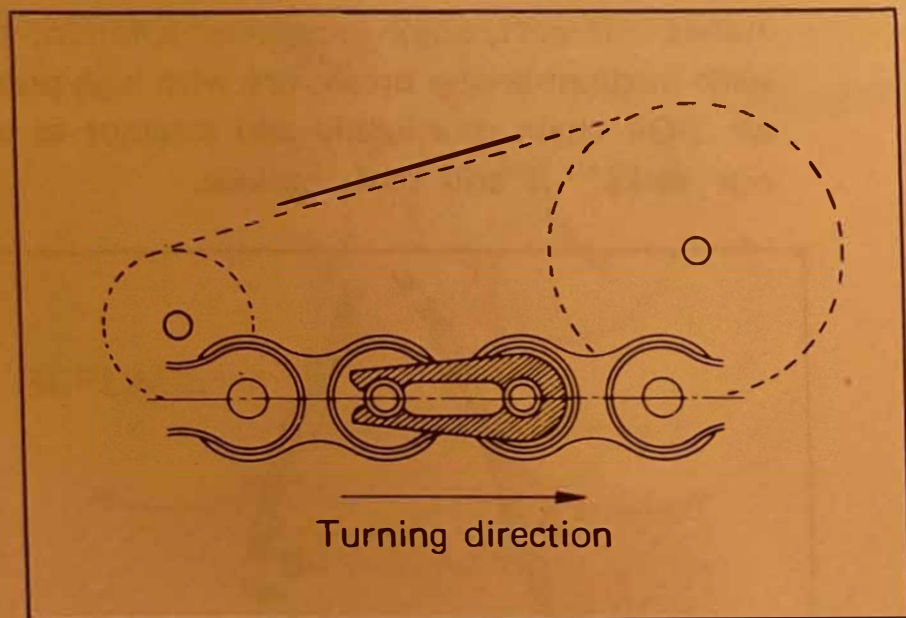

- d. During reassembly, the master link clip must be installed with the rounded end facing the direction of travel.

#### 4. TROUBLESHOOTING

With the chain installed on the machine, excessive wear may be roughly determined by attempting to pull the chain away from the rear sprocket. If the chain will lift away more than one-half the length of the sprocket teeth, remove and inspect.

If any portion of the chain shows signs of damage, or if either sprocket shows signs of excessive wear, remove and inspect.

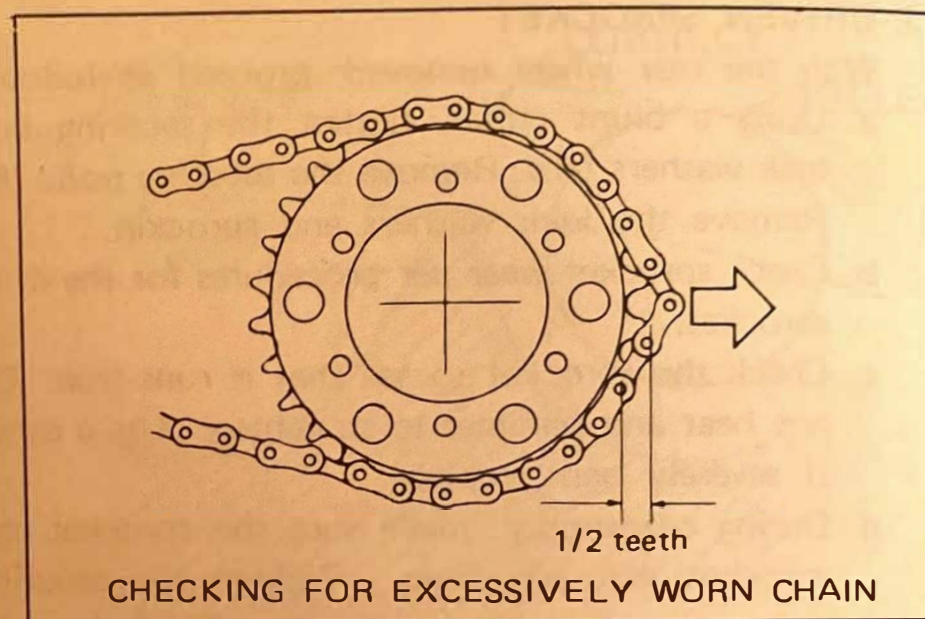

#### 5. MAINTENANCE

The chain should be lubricated per the recommendations given in the Maintenance and Lubrication Schedule Chart located in Chapter I. More often if possible. Preferably after every use.

- Wipe off dirt with shop rag. If accumulation is severe, use soft bristle brush, then rag.
- Apply lubricant between roller and side plates on both inside and outside of chain. Don't skip a portion as this will cause uneven wear. Apply thoroughly. Wipe off excess.

#### NOTE

Chain and lubricant should be at room temperature to assure penetration of lubricant into rollers.

Choice of lubricant is determined by use and terrain. SAE 20wt. or 30wt. may be used, but several specialty types by accessory manufacturers offer more penetration, corrosion resistance and shear strength for roller protection.

In certain areas, semi-drying lubricants are preferable. These will resist picking up sand particles, dust, etc. Consult your Authorized Yamaha Dealer.

- c. Periodically, remove the chain, wipe and/or brush excess dirt off. Blow off with high pressure air.
- d. Soak chain in solvent, brushing off remaining dirt. Dry with high pressure air. Lubricate thoroughly while off machine. Work each roller thoroughly to make sure lubricant penetrates. Wipe off excess. Re-install.

**NOTE**

See Maintenance and Lubrication Schedule Charts located in Chapter I for additional information.

## 6. CABLES

Cable maintenance is primarily concerned with preventing deterioration through rust and weathering; and providing for proper lubrication to allow the cable to move freely within its housing.

Cable removal is straight forward and uncomplicated. Removal will not be discussed within this section. For details, see the individual maintenance section for which the cable is an integral part.

## 7. MAINTENANCE

- a. Remove the cable.
- b. Check for free movement of the cable with its housing. If movement is obstructed, check for fraying of the cable strands. If fraying is evident replace the cable assembly.
- c. To lubricate cable, hold in vertical position. Apply lubricant to uppermost end of cable. Leave in vertical position until lubricant appears at bottom end. Allow excess to drain and reinstall.

**NOTE**

Choice of lubricant depends upon conditions and preference, However, a semi-drying, graphite-base lubricant will probably perform most adequately under most conditions.

Under certain conditions, a water displacing lubricant is more suitable. Check with the Authorized Yamaha Dealer in your area.

## CHAPTER VI. CHASSIS MAINTENANCE AND MINOR REPAIRS

### SECTION A. WHEELS AND TIRES

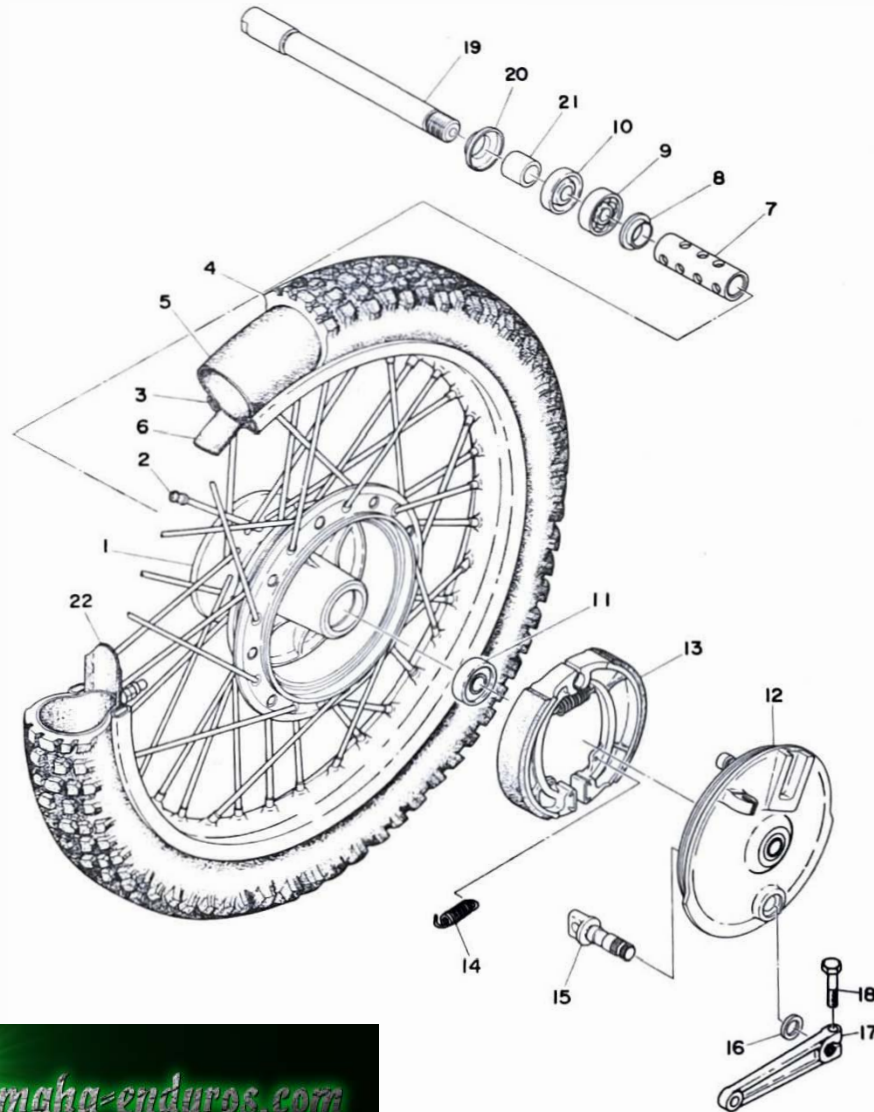

### FRONT WHEEL

1. HUB, front
2. SPOKE SET
3. RIM, front
4. TIRE, front
5. TUBE, front
6. BAND, rim
7. SPACER, bearing
8. FLANGE, spacer 2
9. BEARING
10. OIL SEAL
11. BEARING
12. PLATE, brake shoe
13. BRAKE SHOE COMP.
14. SPRING, brake shoe return
15. CAMSHAFT
16. SEAL, camshaft
17. LEVER, camshaft
18. BOLT
19. SHAFT, wheel
20. COVER, hub dust
21. COLLAR, wheel shaft
22. SPACER, bead

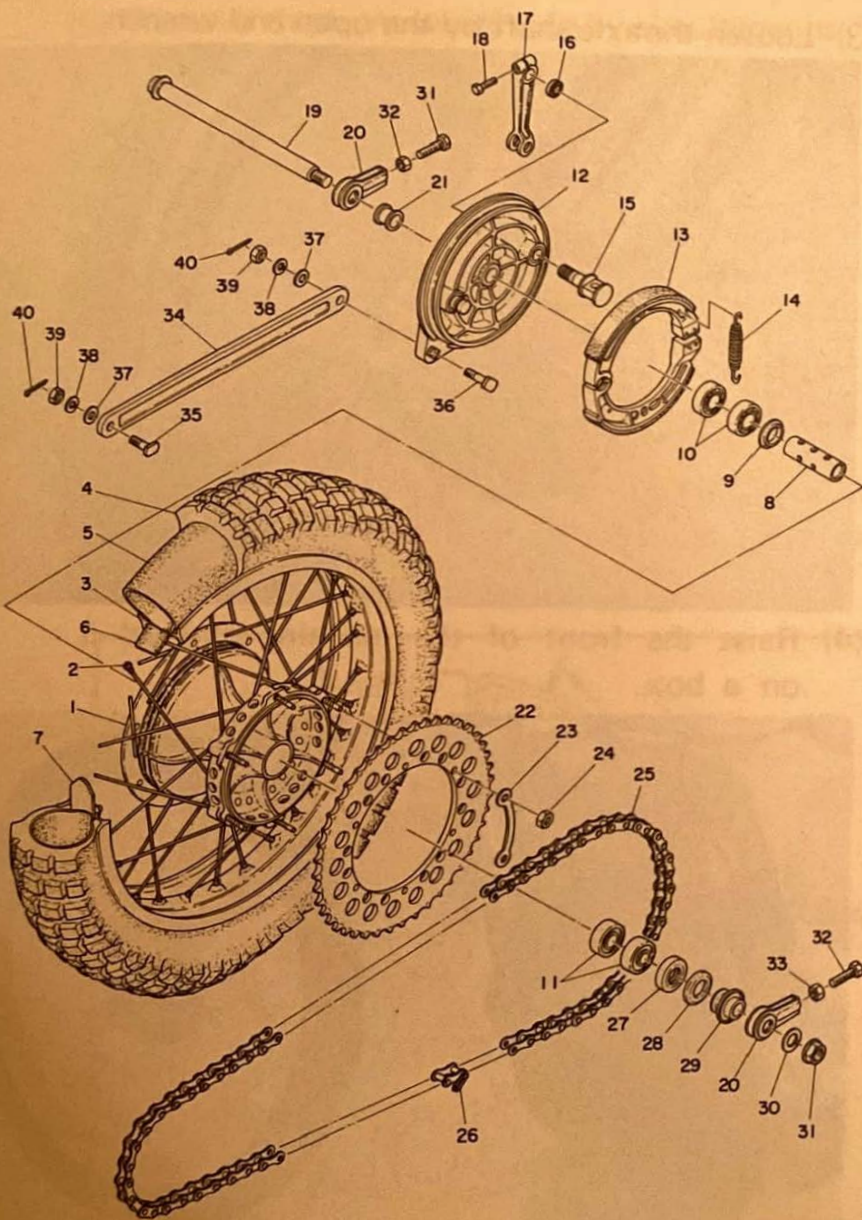

## REAR WHEEL

- |                          |                            |
|--------------------------|----------------------------|
| 1. HUB, rear             | 25. CHAIN                  |
| 2. SPOKE SET             | 26. JOINT, chain           |
| 3. RIM, rear             | 27. OIL SEAL               |
| 4. TIRE, rear            | 28. COVER, dust            |
| 5. TUBE, rear            | 29. COLLAR, sprocket shaft |
| 6. BAND, rim             | 30. WASHER, spring         |
| 7. SPACER, bead          | 31. NUT                    |
| 8. SPACER, bearing       | 32. BOLT, chain puller     |
| 9. FLANGE, spacer        | 33. NUT                    |
| 10. BEARING              | 34. BAR, tension           |
| 11. BEARING              | 35. BOLT                   |
| 12. PLATE, brake shoe    | 36. BOLT                   |
| 13. BRAKE SHOE COMP.     | 37. WASHER, plain          |
| 14. SPRING, tension      | 38. WASHER, spring         |
| 15. CAMSHAFT             | 39. NUT                    |
| 16. OIL SEAL             | 40. PIN, cotter            |
| 17. LEVER, camshaft      |                            |
| 18. BOLT                 |                            |
| 19. SHAFT, wheel         |                            |
| 20. PULLER, chain        |                            |
| 21. COLLAR               |                            |
| 22. GEAR, sprocket wheel |                            |
| 23. WASHER, lock         |                            |
| 24. NUT                  |                            |

## 1. FRONT WHEEL

### A. REMOVAL

- (1) Disconnect the brake cable at the front brake lever.
- (2) Loosen the axle shaft pinch bolt at the bottom of the left-hand fork leg.

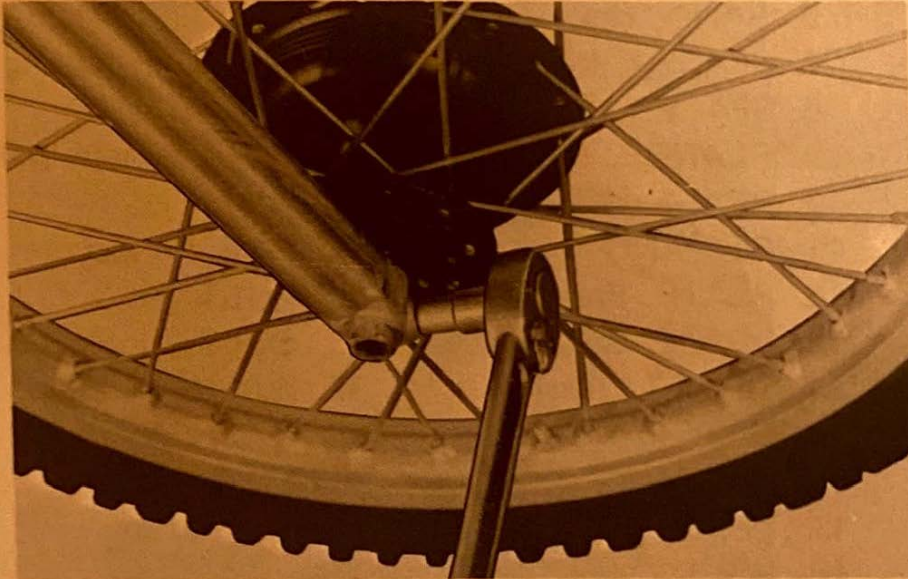

- (3) Loosen the axle shaft by the open end wrench.

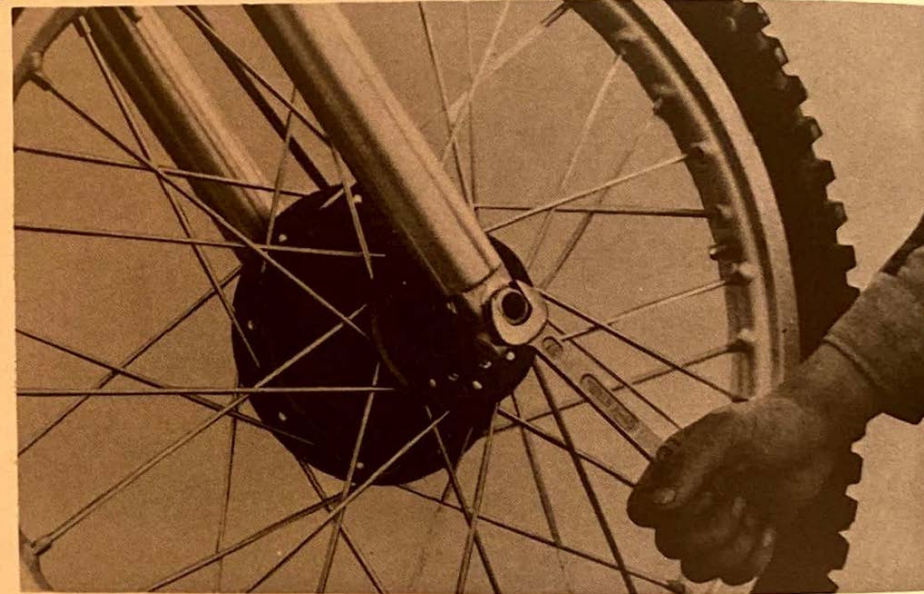

- (4) Raise the front of the machine and set it on a box.



[www.legends-yamaha-enduros.com](http://www.legends-yamaha-enduros.com)

- (5) Remove the front wheel axle by simultaneously twisting and pulling out on the axle. Then remove the wheel assembly.

**NOTE**

Raise the front of the machine by placing a suitable stand under the engine.

**B. CHECKING BRAKE SHOE WEAR**

Measure the outside diameter at the brake shoe with slide calipers. If it measures less than 5.039 ins. (128 mm.)

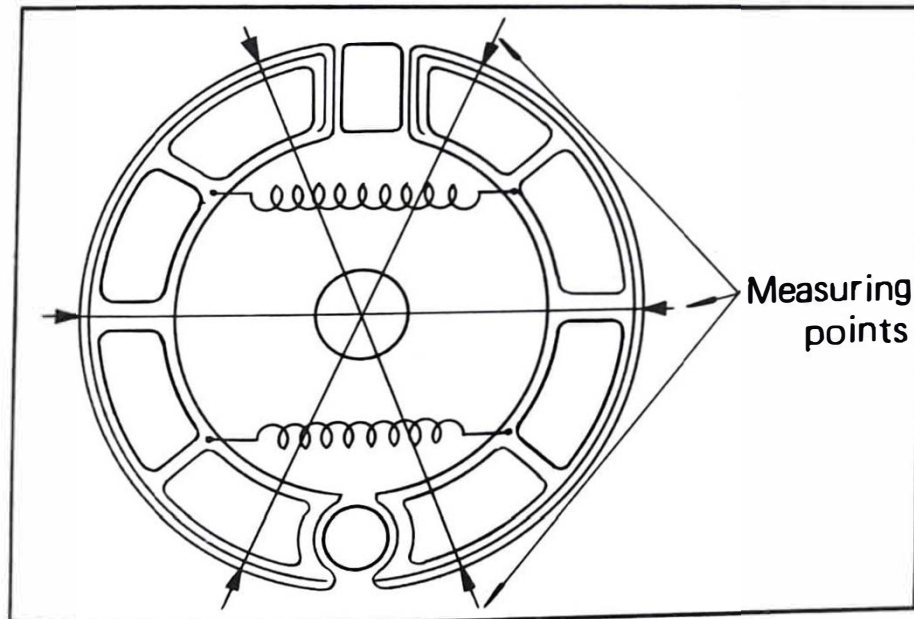

**FRONT BRAKE SHOE DIAMETER:**  
5.118 ins. (130 mm.)

**REPLACEMENT LIMIT:** 0.079 in. (2 mm.)

**C. BRAKE DRUM**

Oil or scratches on the inner surface of the brake drum will impair braking performance or result in abnormal noises. Remove oil by wiping with a rag soaked in lacquer thinner or solvent. Remove scratches by lightly and evenly rubbing with emery cloth.

**D. REPLACING WHEEL BEARINGS**

If the bearings allow excessive play in the wheel or if it does not turn smoothly, replace the bearing as follows.

- (1) First clean the outside of the wheel hub.
- (2) Insert the bent end of the special tool into the hole located in the center of the bearing spacer, and drive the spacer out from the hub by tapping the other end of the special tool with a hammer. (Both bearing spacer and space flange can easily be removed.)
- (3) Push out the bearing on the other side.
- (4) To install the wheel bearing, reverse the above

sequence. Be sure to grease the bearing before installation and use the bearing fitting tool (furnished by Yamaha).

- (5) Check the lips of the seals for damage or warpage. Replace if necessary.

## E. SPOKES

Check the spokes. If they are loose or bent, tighten or replace them. If the machine is ridden in rough country often, or raced, the spokes should be checked regularly.

## 2. REAR WHEEL

### A. REMOVAL

- (1) Remove the tension bar and brake rod from rear shoe plate.
- (2) Remove cotter pin from rear wheel shaft nut.
- (3) Remove the rear wheel shaft nut.
- (4) Pull out the rear wheel shaft by simultaneously twisting and pulling out.
- (5) Remove the rear brake shoe plate.
- (6) Lean the machine to the left and remove the rear wheel assembly.

### B. CHECKING BRAKE SHOE WEAR

Measure the outside diameter at the brake shoe with slide calipers. If it measures less than 6.220 ins. (158 mm.)

REAR BRAKE SHOE DIAMETER:

6.299 ins. (160 mm.)

REPLACEMENT LIMIT: 0.079 in. (2 mm.)

### C. BRAKE DRUM

Oil or scratches on the inner surface of the brake drum will impair braking performance or result in abnormal noises. Remove oil by wiping with a rag soaked in lacquer thinner or solvent. Remove scratches by lightly and evenly rubbing with emery cloth.

### D. REPLACING WHEEL BEARINGS

Refer to front wheel section.

### E. CHECKING RIMS AND SPOKES

(Front & Rear Wheels)

#### (1) Checking for loose spokes

Loose spokes can be checked by bracing the machine off the ground so that the front wheel can spin free. Slowly revolve the front wheel and at the same time let the metal shaft of a fairly heavy screwdriver bounce off each spoke. If all the spokes are tightened approximately the same then the sound given off by the screwdriver hitting the spokes should sound the same. If one spoke makes a dull flat sound, then check it for looseness.

(2) Smooth out a rough shoe surface with sandpaper or with a file.

(3) Checking rim "run-out"

While you have the machine up in the air, you should check that the front wheel does not have too much run-out. "Run-out" is the amount the front wheel deviates from a straight line as it spins. Secure the front forks to keep them from turning. Set up a dial indicator or solidly anchor a pointer about 0.12 in. (3 mm.) away from the side of the rim. As the wheel spins, the distance between the pointer and the rim should not change more than 0.079 in. (2 mm.) total. Any greater fluctuation means that you should remove this rim warpage by properly adjusting the spokes.

RUN-OUT LIMITS: 0.079 in. (2 mm.)

#### F. TIRE REMOVAL

- (1) Remove valve cap, valve core, valve stem lock nut, and rim lock nuts.
- (2) When all air is out of tube, separate tire bead from rim (both sides) by stepping on tire with your foot.
- (3) Use two tire removal irons (with rounded edges) and begin to work the tire bead over the edge of the rim, starting 180° opposite

the tube stem. Take care to avoid pinching the tube as you do this.

- (4) After you have worked one side of the tire completely off the rim, then you can slip the tube out. Be very careful not to damage the stem while pushing it back out to the rim hole.

#### NOTE

If you are changing the tire itself, then finish the removal by working the tire off the same rim edge.

#### G. INSTALLING TIRE

Re-installing the tire assembly can be accomplished by reversing the disassembly procedure. The only different in procedure would be right after the tube has been installed, but before the tire has been completely slipped onto the rim, inflate the tube. This removes any creases that might exist. Release the air and continue with reassembly. Also, right after the tire has been completely slipped onto the rim, check to make sure that the stem is squarely in the center of the hole in the rim.

#### TIRE PRESSURE FOR NORMAL RIDING:

Front - 13 lbs/in<sup>2</sup> (0.91 kgs/cm<sup>2</sup>)  
Rear - 15 lbs/in<sup>2</sup> (1.05 kgs/cm<sup>2</sup>)



## SECTION B. FRONT FORKS AND STEERING HEAD

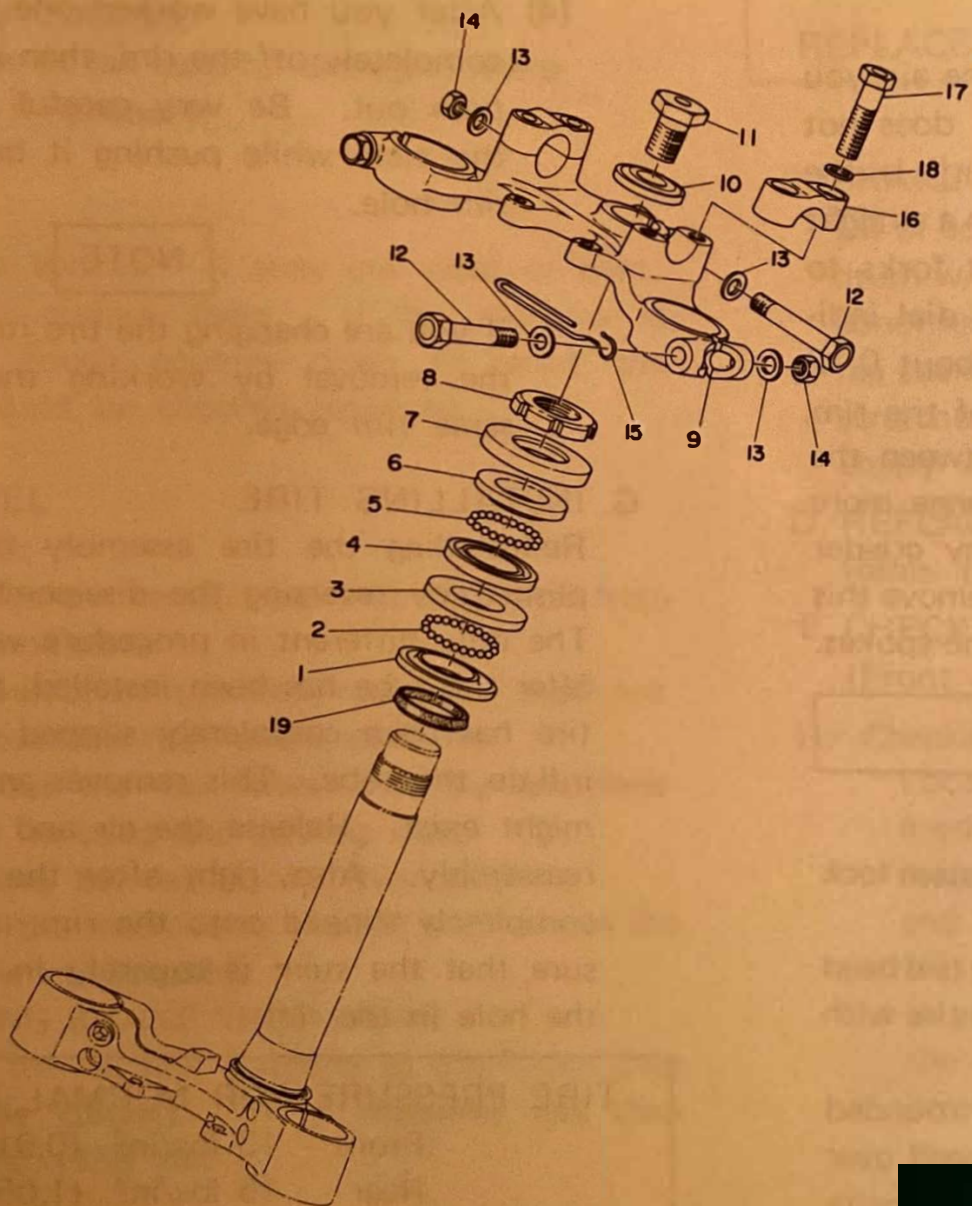

## STEERING

1. RACE, ball 1
2. BALL
3. RACE, ball 2
4. RACE, ball 2
5. BALL
6. RACE, ball 1
7. COVER, ball race
8. NUT, steering fitting
9. CROWN, handle
10. WASHER, crown
11. BOLT, steering fitting
12. BOLT, handle crown
13. WASHER, plate
14. NUT
15. HOLDER, wire
16. HOLDER, handle upper
17. BOLT, fitting
18. WASHER, spring
19. SEAL, dust

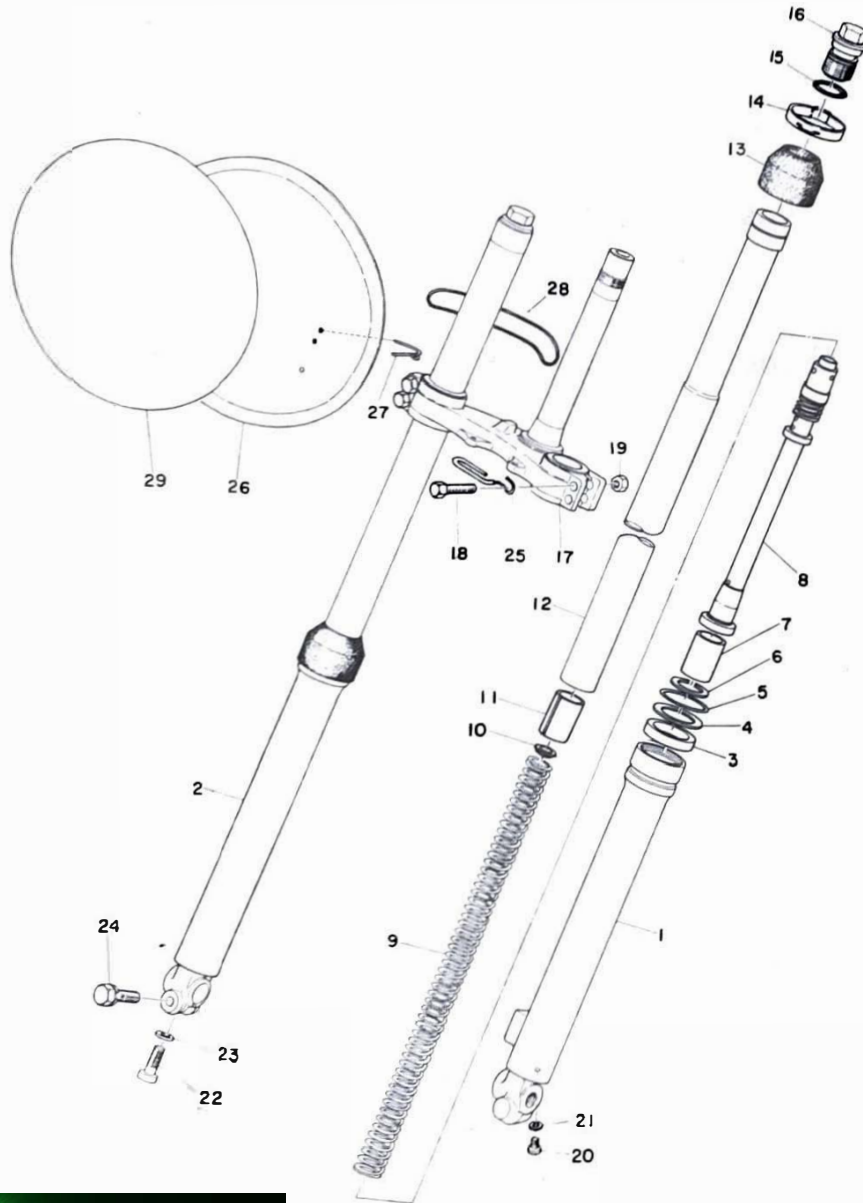

## FRONT FORK

1. TUBE, outer left
2. TUBE, outer right
3. OIL SEAL
4. WASHER, oil seal
5. CLIP, oil seal
6. CIRCLIP
7. PISTON
8. CYLINDER COMP.
9. SPRING, fork
10. SEAT, spring upper
11. SPACER
12. TUBE, inner
13. SEAL, dust
14. HOLDER, wire
15. O-RING
16. BOLT, cap
17. UNDER BRACKET COMP.
18. BOLT, under bracket
19. NUT
20. PLUG, drain
21. GASKET, drain plug
22. BOLT
23. PACKING
24. BOLT
25. HOLDER, wire
26. PLATE, number
27. STAY, number plate
28. O-RING
29. EMBLEM, number

## 1. GENERAL

The front forks on your machine utilize chrome plated tubular steel fork legs (inner tubes) and tubular aluminum sliders (outer tubes). The bearing surface is the entire inside surface of the aluminum outer tube.

The steering head pivot is supported by two sets of uncaged ball and race bearing assemblies.

## 2. FRONT FORK OIL CHANGE

- a. With the front wheel removed or raised off the floor with a suitable frame stand, remove cap bolts on inner fork tubes.

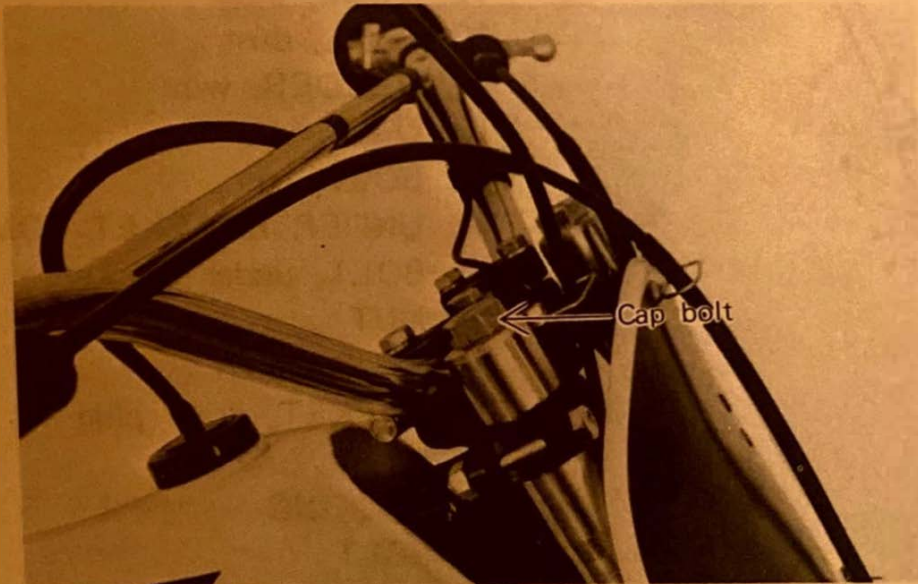

- b. Remove drain screw from each outer tube with open container under each drain hole.

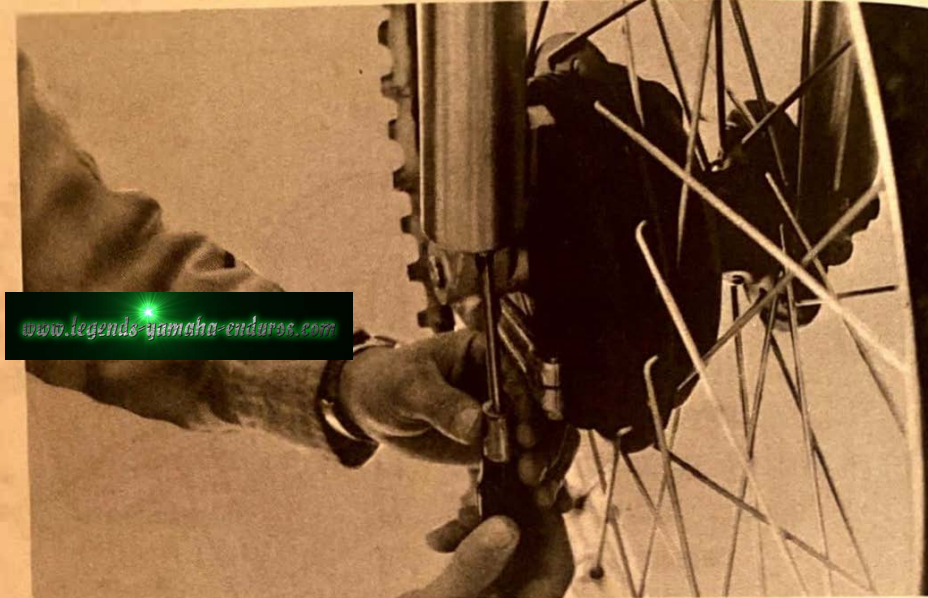

- c. After most of oil has drained, slowly raise and lower outer tubes to pump out remaining oil.
- d. Replace drain screws.

### NOTE

Check gaskets, replace if damaged.

- e. Measure correct amount of oil and pour into each leg.

RECOMMENDED OIL:	SAE10W/30
------------------	-----------

QUANTITY PER LEG:	6.2 oz. (184 c.c.)
-------------------	--------------------

NOTE

Select the weight oil that suits local conditions and your preference (lighter for less damping; heavier for more damping).

FORK CAP BOLT TORQUE:  
21.7 - 28.9 ft-lbs. (3.0 - 4.0 m-kgs.)

- f. After filling, slowly pump the outer tubes up and down to distribute the oil.
- g. Inspect O-ring on fork cap bolts and replace if damaged.
- h. Replace fork cap bolts and torque to specification.



### 3. STEERING HEAD ADJUSTMENT

a. With front wheel elevated, grasp bottoms of fork legs and gently push and pull to check steering head freeplay. There should be no noticeable freeplay.

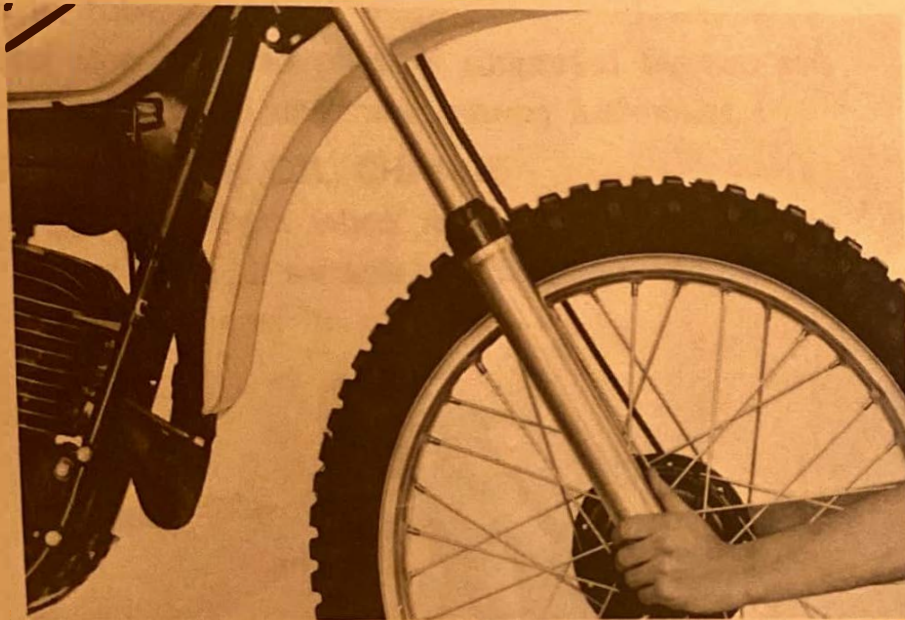

b. To adjust, first loosen upper stem pinch bolt.

c. Loosen stem bolt.

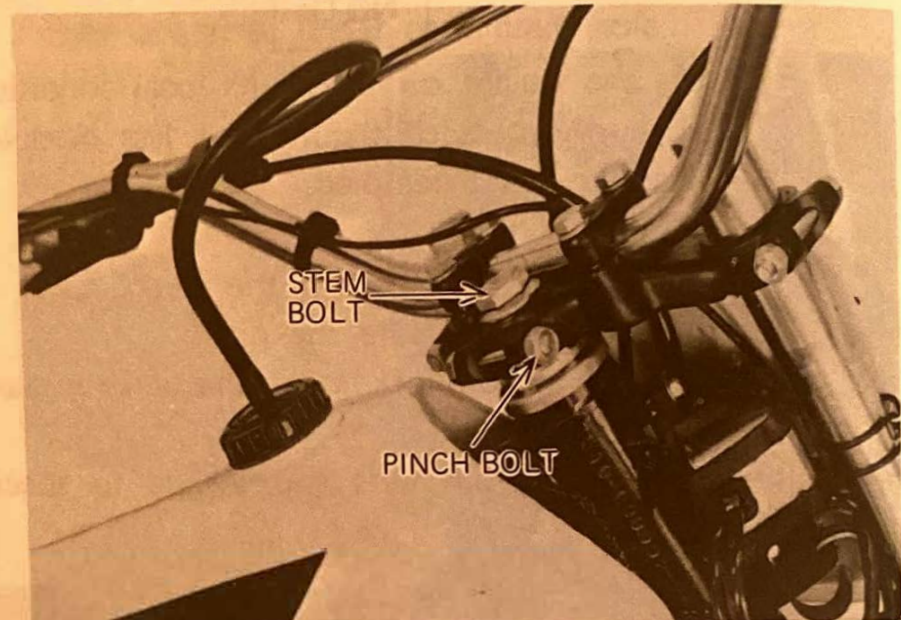

d. Use ring nut wrench to tighten adjust nut. Tighten until freeplay is eliminated.

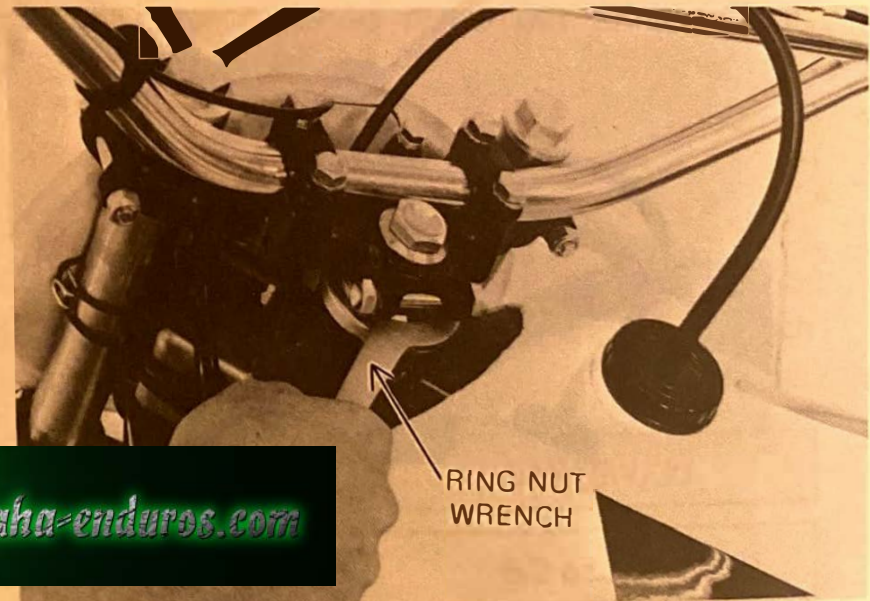

[www.legends-yamaha-enduros.com](http://www.legends-yamaha-enduros.com)

**–CAUTION–**

FORKS MUST SWING FROM LOCK TO LOCK WITHOUT BINDING OR CATCHING.

- e. Tighten stem bolt and torque to specification.

**STEM BOLT TORQUE:**

21.7 - 28.9 ft-lbs. (3.0 - 4.0 m-kgs.)

- f. Tighten pinch bolts at fork crown and torque to specification.

**STEM PINCH BOLT TORQUE:**

14.5 ft-lbs. (2.0 m-kgs.)

**NOTE**

For steering head disassembly – refer to DT250B/400B Service Manual for correct procedure.

**SECTION C. REAR SHOCK (MONOCROSS SUSPENSION) AND SWING ARM**

**–CAUTION–**

**READ INSTRUCTIONS BELOW**

1. Monocross Suspension Unit contains highly compressed nitrogen gas.
2. Use only nitrogen gas for refilling. Other gases may result in explosion.
3. Do not inclinerate.
4. Monocross Suspension Unit should be serviced only by Authorized Yamaha Dealer.

**NORMAL OPERATING PRESSURE:**

313 p.s.i. (22.03 kg/cm<sup>2</sup>)

**MAXIMUM PRESSURE:** 426 p.s.i. (30.0 kg/cm<sup>2</sup>)

**1. REAR SHOCK (MONOCROSS SUSPENSION) REMOVAL**

- a. Remove the two bolts securing the rider's seat, and remove the seat. Then remove nut securing the fuel tank (before this operation, the fuel petcock lever must be placed in OFF, and the fuel pipe must be removed at the carburetor side. The air vent pipe must also be removed). Lift up the rear of the fuel tank slightly, and pull it backward. The two rubber dampers (on both

sides of front bottom of the fuel tank) will come off the frame.

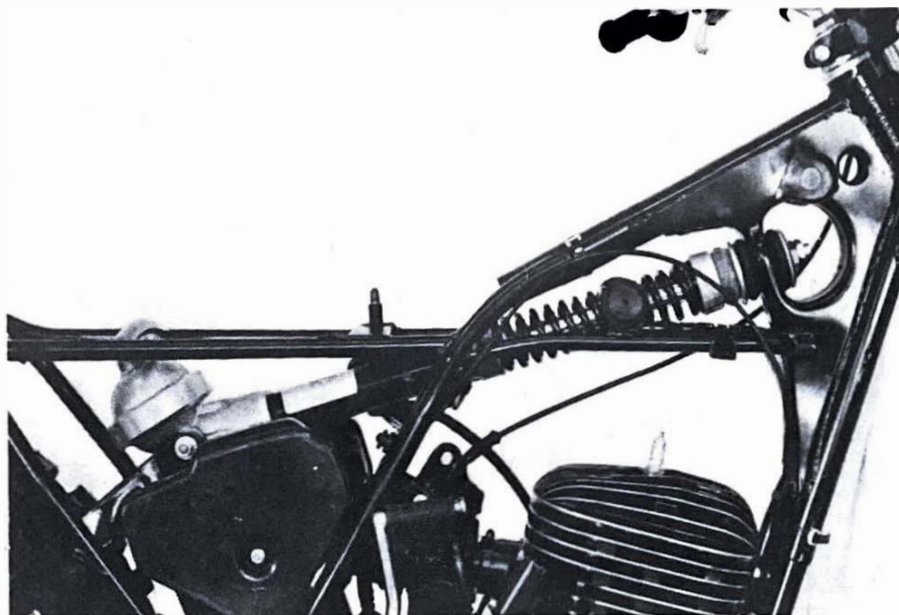

- b. Next, remove the two pivot shaft nuts on the front part of the rear shock (Monocross suspension), and remove the washer, and rubber.

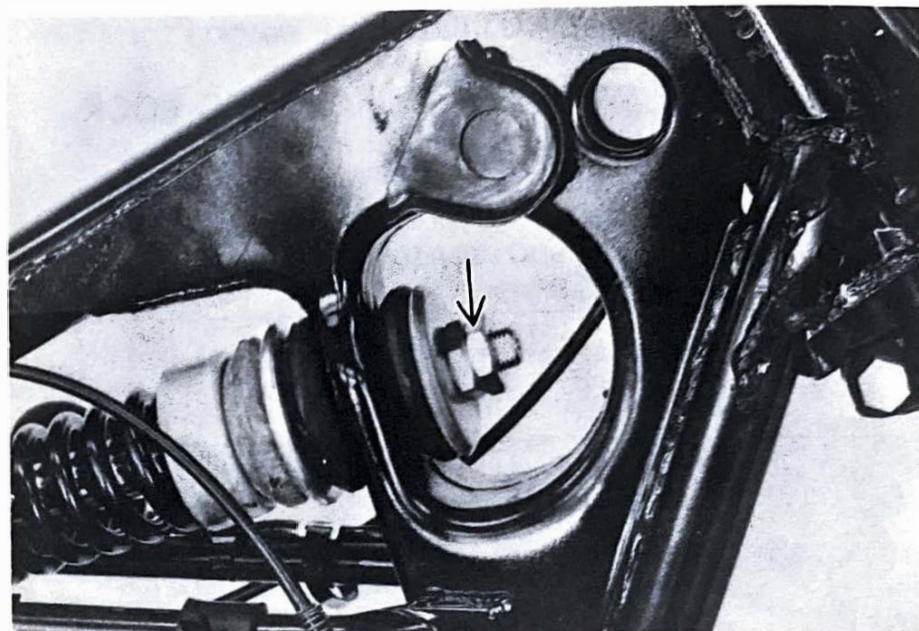

PIVOT SHAFT NUTS TORQUE:  
50.63 ft-lbs. (7 m-kgs.)

- c. Next, remove the bolt securing the membrane housing to the rear of the frame. The bolt is held by a stopper so it does not turn when the nut is screwed out. Loosen the nut first, and remove the bolt. Take care so the two washer are not lost.

MEMBRANE HOUSING INSTALL NUT TORQUE:  
14.47 ft-lbs. (2 m-kgs.)

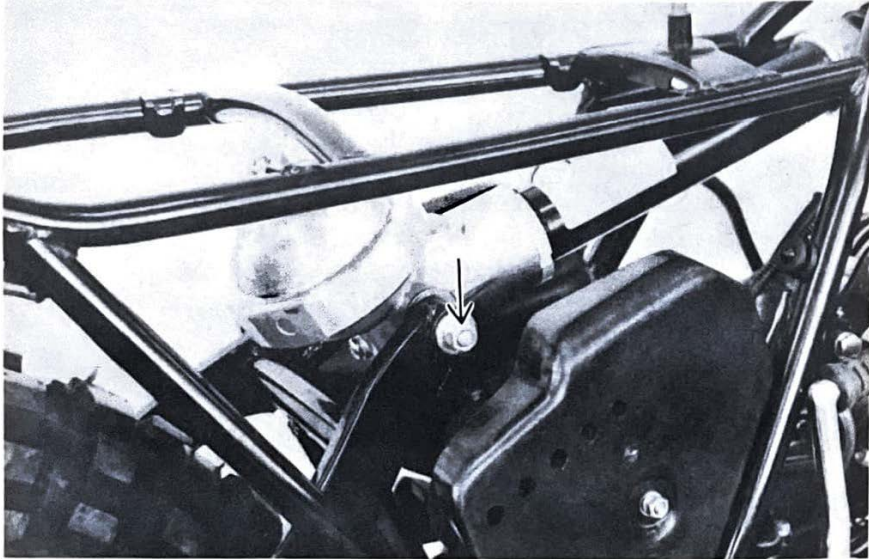

- d. Remove the rear shock from the frame. (To remove, pull the rear shock backward while lifting up the swing arm.)





## 2. REAR SHOCK SPRING REPLACEMENT

- a. Cover the bolt hole areas of the membrane housing with a rag or rubber tube, and grip it in a vise. Using a pipe wrench or a monkey wrench, remove the T-nut. If any nut is damaged, replace.

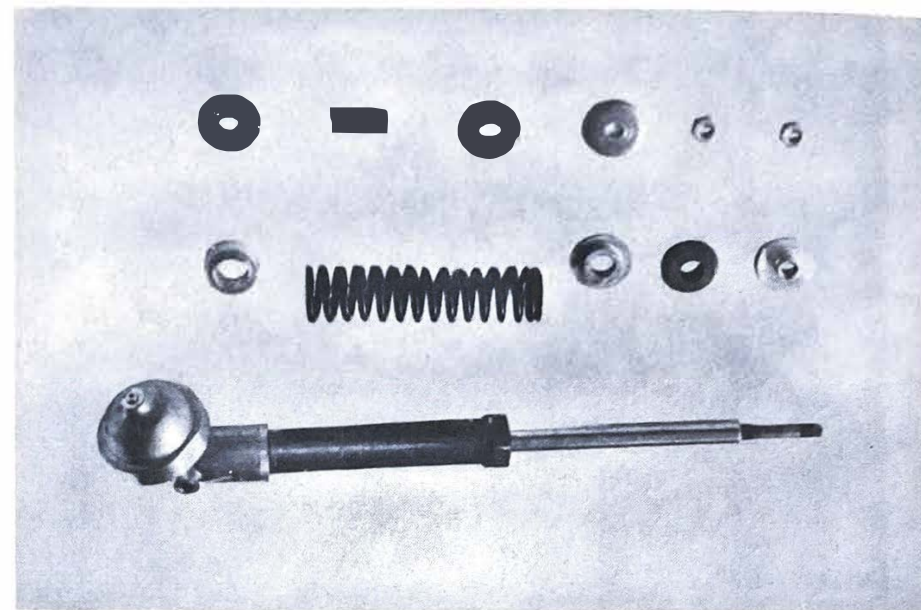
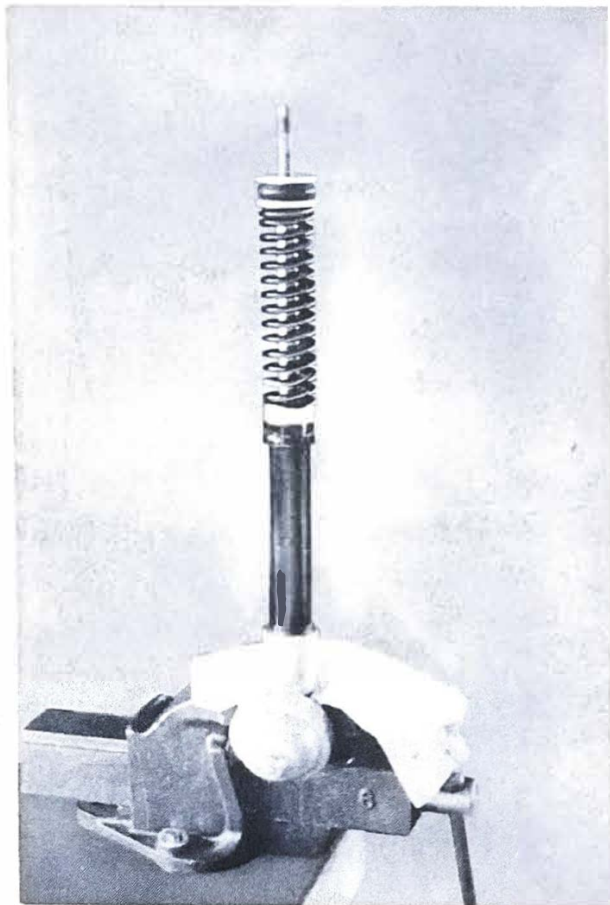

T-NUT TORQUE: 10.85 ft-lbs. (1.5 m-kgs.)

[www.legends-yamaha-enduros.com](http://www.legends-yamaha-enduros.com)

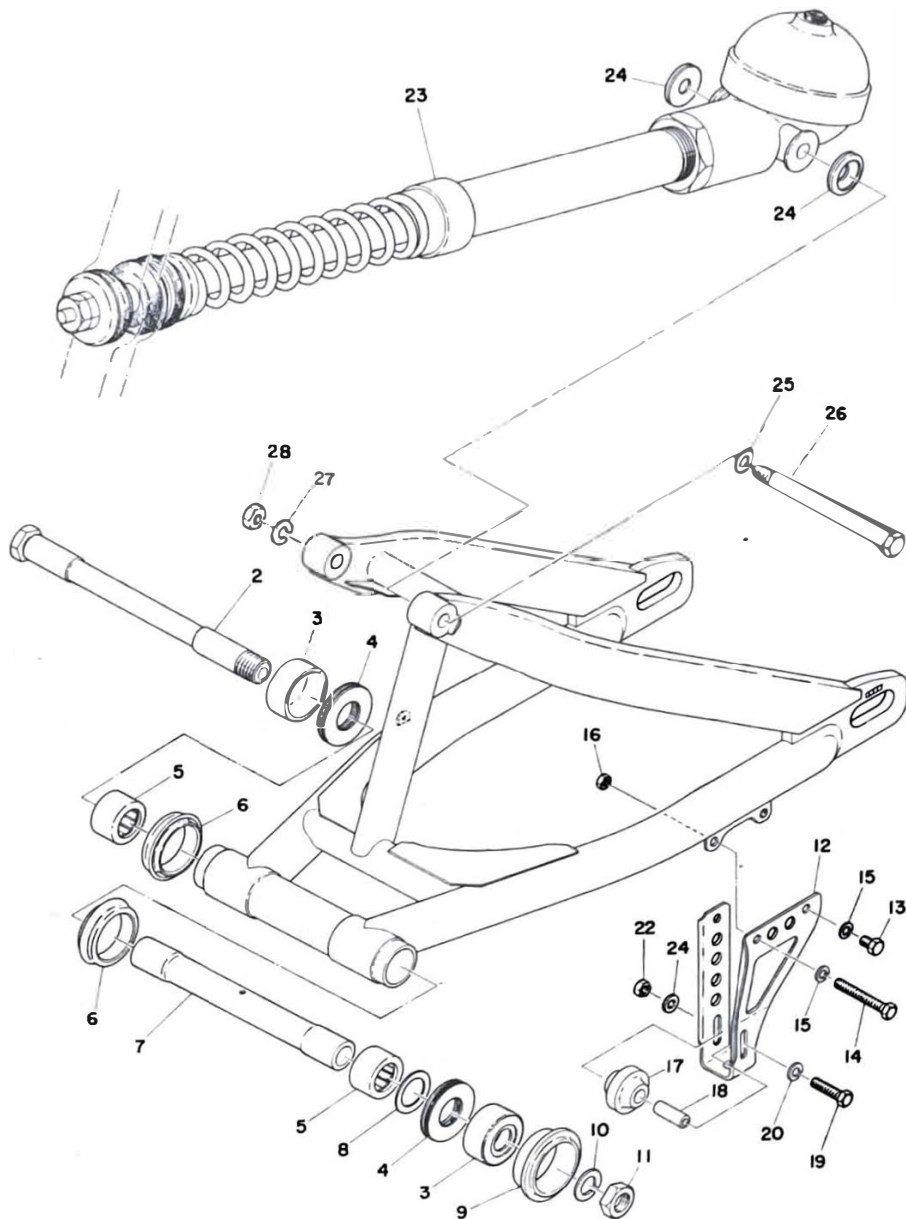

- REAR ARM - REAR SHOCK ABSORBER
- |                               |                    |
|-------------------------------|--------------------|
| 1. REAR ARM COMP.             | 25. WASHER         |
| 2. SHAFT, pivot               | 26. BOLT           |
| 3. COVER, thrust              | 27. WASHER, spring |
| 4. BEARING                    | 28. NUT            |
| 5. BEARING                    |                    |
| 6. OIL SEAL                   |                    |
| 7. BUSH 2                     |                    |
| 8. WASHER, plate              |                    |
| 9. SEAL, guard                |                    |
| 10. WASHER, spring            |                    |
| 11. NUT, hexagon              |                    |
| 12. GUARD, chain              |                    |
| 13. BOLT                      |                    |
| 14. BOLT                      |                    |
| 15. WASHER, spring            |                    |
| 16. NUT                       |                    |
| 17. TENSIONER                 |                    |
| 18. SPACER, chain guard       |                    |
| 19. BOLT                      |                    |
| 20. WASHER, plain             |                    |
| 21. WASHER, plain             |                    |
| 22. NUT                       |                    |
| 23. REAR SHOCK ABSORBER ASS'Y |                    |
| 24. COVER, thrust             |                    |

In addition to the standard type, two different type rear shock springs are sold. A proper type should be selected according to the conditions of a racing course or the weight of the rider.

Type	Part No.	Spring constant kg/mm	Color cords
Soft	90501-80240	3.8	Painted white
Standard	90501-80320	4.1	None painted
Hard	90501-80239	4.2	Painted Blue

NOTE

For assembly, the above mentioned procedure should be reversed.

- a. For adjustment or replacement of the nitrogen gas, or change of the shock absorber oil in the accumulator, or for disassembly of the accumulator, or for disassembly of the accumulator, consult your authorized Yamaha dealer.

**3. SWING ARM INSPECTION**

- a. With rear wheel and membrane housing bolt removed, grasp the ends of the arm and move from right to left to check for freeplay.

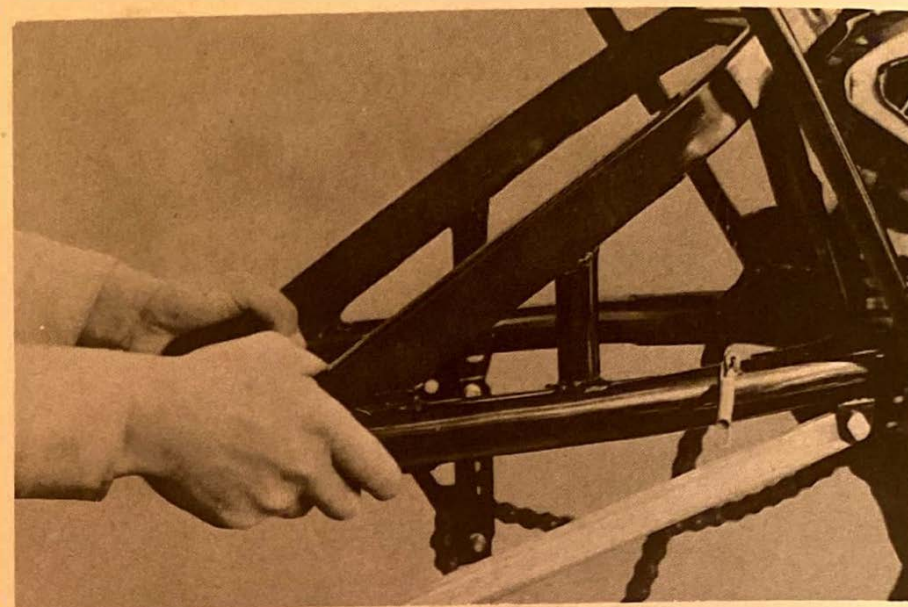

SWING ARM FREEPLAY:                      None

- b. If freeplay is excessive, remove swing arm and replace swing arm bushing.

**4. SWING ARM PIVOT LUBRICATION**

- a. The swing arm must be disassembled to lubricate.

RECOMMENDED LUBRICANT:            90wt.  
smooth lube grease

# CHAPTER VII. MISCELLANEOUS

## SECTION A. CONVERSION TABLES

Metric to Inch System

KNOWN	MULTIPLIER (Rounded off)	RESULT
<b>TORQUE</b>		
m-kg.	7.233	ft-lb.
m-kg.	86.80	in-lb.
cm-kg.	0.0723	ft-lb.
cm-kg.	0.8680	in-lb.
<b>WEIGHT</b>		
kg.	2.205	lb.
g.	0.03527	oz.
<b>FLOW/DISTANCE</b>		
km/lit.	2.352	m.p.g.
km/h.	0.6214	m.p.h.
km.	0.6214	mi.
m.	3.281	ft.
m.	1.094	yd.
cm.	0.3937	in.
mm.	0.03937	in.
<b>VOLUME/CAPACITY</b>		
c.c.	0.03382	oz. (U.S. liq.)
c.c.	0.06102	cu.in.
lit.	2.1134	pt. (U.S. liq.)
lit.	1.057	qt. (U.S. liq.)
lit.	0.2642	gal. (U.S. liq.)
<b>MISC.</b>		
kg/mm.	56.007	lb/in.
kg/cm. <sup>2</sup>	14.2233	psi. (lb/in. <sup>2</sup> )
Centigrade( °C)	9/5( °C) +32	Fahrenheit ( °F)

Inch to Metric System

KNOWN	MULTIPLIER (Rounded off)	RESULT
<b>TORQUE</b>		
ft-lb.	0.13826	m-kg.
ft-lb.	13.831	cm-kg.
in-lb.	0.01152	m-kg.
in-lb.	1.1521	cm-kg.
<b>WEIGHT</b>		
lb.	0.453	kg.
oz.	28.3	g.
<b>FLOW/DISTANCE</b>		
mi/gal.	0.4252	km/lit.
mi/h.	1.609	km/h.
mi.	1.609	km.
ft.	0.3048	m.
yd.	0.9141	m.
in.	2.54	cm.
in.	25.4	mm.
<b>VOLUME/CAPACITY</b>		
oz. (U.S.liq.)	29.57	c.c.
cu.in.	16.38	c.c.
pt. (U.S.liq.)	0.4732	lit.
qt. (U.S.liq.)	0.9461	lit.
gal. (U.S.liq.)	3.785	lit.
<b>MISC.</b>		
lb/in.	0.017855	kg/mm.
psi. (lb/in. <sup>2</sup> )	0.07031	kg/cm. <sup>2</sup>
Fahrenheit(°C)	5/9 (°F -32)	Centigrade(°C)

**DEFINITION OF TERMS:**

m-kg. - Meter-kilogram: Usually torque.  
 g. - Gram(s).  
 kg. - Kilogram(s): 1,000 grams.  
 km. - Kilometer(s).

lit. - Liter(s).  
 km/lit.- Kilometer(s) per liter: Mileage.  
 c.c. - Cubic centimeter(s)(cm<sup>3</sup>): Volume capacity.  
 kg/mm.- Kilogram(s) per millimeter: Usually spring compression rate.  
 kg/cm.<sup>2</sup>- Kilogram(s) per square centimeter: Pressure

## SECTION B. CLEANING AND STORAGE

### CLEANING

Frequent thorough cleaning of your motorcycle will not only enhance its appearance, but will improve general performance and extend the useful life of many components.

1. Before cleaning the machine:
  - a. Block off end of exhaust pipe to prevent water entry; a plastic bag and strong rubber band may be used.
  - b. Remove air cleaner or protect it from water with plastic covering.

#### NOTE

With air cleaner removed make sure no water enters intake.

- c. Make sure spark plug, gas cap, oil tank cap, transmission oil filler cap and battery caps are properly installed.
2. If engine case is excessively greasy, apply degreaser with a paint brush. Do not apply degreaser to chain, sprockets, or wheel axles.
  3. Rinse dirt and degreaser off with garden hose, using only enough hose pressure to do the job. Excessive hose pressure may cause water seepage and contamination of wheel bearings, front forks, brake drums,

and transmission seals. Many expensive repair bills have resulted from improper high-pressure detergent applications such as those available in coin-operated car washers.

4. Once the majority of dirt has been hosed off, wash all surfaces with warm water and mild, detergent-type soap. An old tooth brush or bottle brush is handy to reach those hard to get to places.
5. Rinse machine off immediately with clean water and dry all surfaces with a chamois skin, clean towel, or soft absorbent cloth.
6. Immediately after washing, remove excess moisture from chain and lubricate to prevent rust.
7. Chrome-plated parts such as handlebars, rims, spokes, forks, etc. may be further cleaned with automotive chrome cleaner.
8. Clean the seat with a vinyl upholstery cleaner to keep the cover pliable and glossy.
9. Automotive-type wax may be applied to all painted and chrome-plated surfaces. Avoid combination cleaner-waxes. Many contain abrasives which may mar paint or protective finish on fuel and oil tanks.
10. After finishing, start the engine immediately and allow to idle for several minutes.

## STORAGE

Long term storage (30 days or more) of your motorcycle will require some preventive procedures to insure against deterioration. After cleaning machine thoroughly, prepare for storage as follows:

1. Drain fuel tank, fuel lines, and carburetor float bowl(s).
2. Remove empty fuel tank, pour a cup of 10W to 30W oil in tank, shake tank to coat inner surfaces thoroughly and drain off excess oil. Re-install tank.
3. Remove spark plug, pour about one table-spoon of 10W to 30W oil in spark plug hole and reinstall spark plug. Kick engine over several times (with ignition off) to coat cylinder wall with oil.
4. Remove drive chain. Clean thoroughly with solvent and lubricate with graphite-base chain lubricant. Re-install chain or store in a plastic bag (tie to frame for safe-keeping).
5. Lubricate all control cables.
6. Block up frame to raise both wheels off ground. (Main stands can be used on machines so equipped).
7. Deflate tires to 11.5 lbs/in.<sup>2</sup> (0.85 kg/cm<sup>2</sup> )
8. Tie a plastic bag over exhaust pipe outlet to prevent moisture entering.
9. If storing in humid or salt-air atmosphere, coat all exposed metal surfaces with a light film of oil. Do not apply oil to rubber parts or seat cover.

## SECTION C. WARRANTY

The MX models have been designed expressly for competition. Many components have been extensively lightened. The power produced by the engines is considerably above that of a "stock" unit. In light of these facts, and considering the use to which the machines will be put, Yamaha provides no warranty – either express or implied – on any MX model motorcycle.

If any questions arise regarding your MX consult your Authorized Yamaha Dealer, or:

### U.S. DISTRIBUTOR

Yamaha International Corporation  
6600 Orangethorpe  
Buena Park, California 90620  
U.S.A.

YAMAHA MOTOR CANADA LTD.  
1350 Verdun Place  
Richmond, British Columbia  
CANADA

# SECTION D. MAINTENANCE RECORD

DATE	MILES	ITEM	REMARKS





[www.legends-yamaha-enduros.com](http://www.legends-yamaha-enduros.com)



SINCE 1887

**YAMAHA MOTOR CO., LTD.**

IWATA, JAPAN

Printed in Japan

74.10-3.0x1 ♻️

LIT-11625-10-00