



YAMAHA

NOTICE

MX100F/G

SUPPLEMENTARY ASSEMBLY MANUAL



LIT-11666-MX-01

www.legends-yamaha-enduros.com

FOREWORD

This supplementary Assembly Manual for MX100F has been published to supplement the Assembly Manual for DT100D. For complete information on assembly procedures, it is necessary to use this Supplementary Assembly Manual together with the Assembly Manual for the DT100D (90894-07620) (LIT-11666-00-36).

NOTICE

The service specifications given in this Assembly Manual are based on the model as manufactured. If the design of this model is modified, the service specifications may be subject to change in the future.

If any significant change is introduced into the specifications or service procedure, Yamaha dealers will be notified through technical service information to be published by Yamaha.

The assembly procedure is described in the order that the mechanic should follow, and the correct service tools should be used in the correct and professional manner. For this reason, this manual is directed only to trained and experienced Yamaha service personnel. Failure to correctly assemble and service this machine could lead to damage to the machine and possible injury to its operator.

**MX100F
SUPPLEMENTARY ASSEMBLY MANUAL
1st EDITION, OCTOBER 1978
OVERSEAS SERVICE DEPARTMENT
YAMAHA MOTOR CO., LTD.
IWATA, JAPAN
LIT-11666-01-63**

www.legends-yamaha-enduros.com

PARTS CHECK LIST

Parts List: Cardboard crate

No.	Part name	Q'ty
1	Seat	1
2	Front wheel assembly	1
3	Foot rest	1
4	Front fender	1
5	Carton box "A"	1

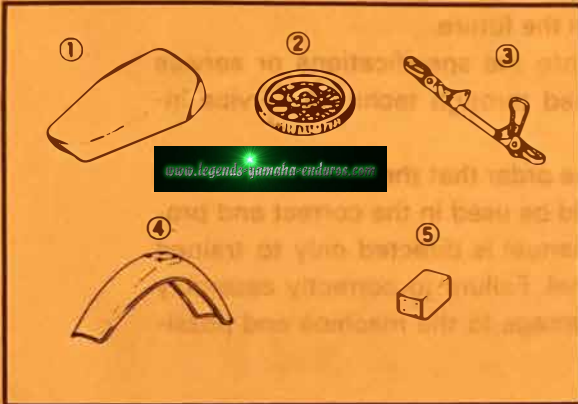

Parts List: Vinyl bag "A"

No.	Part name	Q'ty	Remarks
1	Plate washer	4	Front fender
2	Bolt with washer	4	
3	Nut	4	
4	Bolt with washer	2	Wire holder
5	Stopper	1	Seat
6	Clevis pin	1	
7	Bolt with washer	1	Front wheel
8	Cotter pin	1	
9	Clamp	2	Tank breather hose
10	Bolt	1	Foot rest
11	Bolt	1	

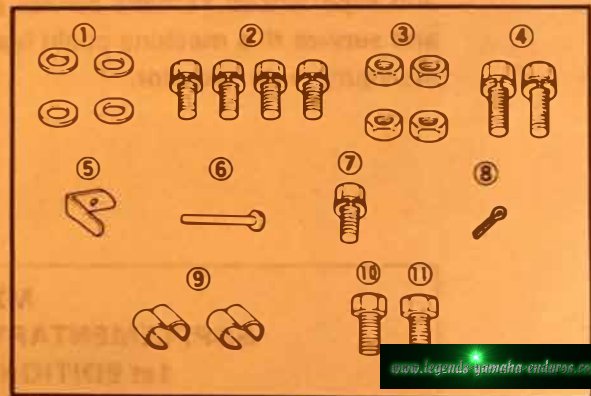

Parts List: Carton box "A"

No.	Part name	Q'ty
1	Owner's manual	1
2	Tool kit	1
3	Tool band	1
4	Tool cover	1
5	Tank breather hose	1
6	Wire holder	1
7	Switch cord band	2
8	Vinyl bag "A"	1

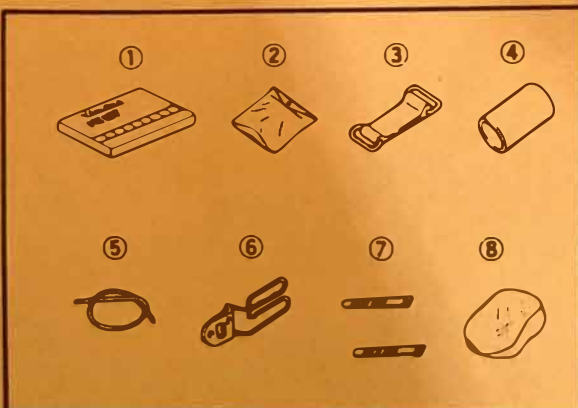

Parts List: Foam tray

No.	Part name	Q'ty
1	Brake shoe plate assembly	1
2	Brake cable assembly	1
3	Shift pedal	1
4	Handlebar assembly	1
5	Collar	1
6	Vinyl bag "B"	1

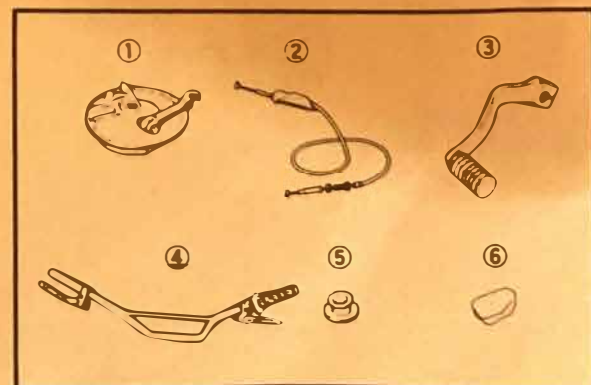

Parts List: Vinyl bag "B"

No.	Part name	Q'ty	Remarks
1	Bolt	1	Shift pedal
2	Handle upper holder	2	Handlebar
3	Flange bolt	4	

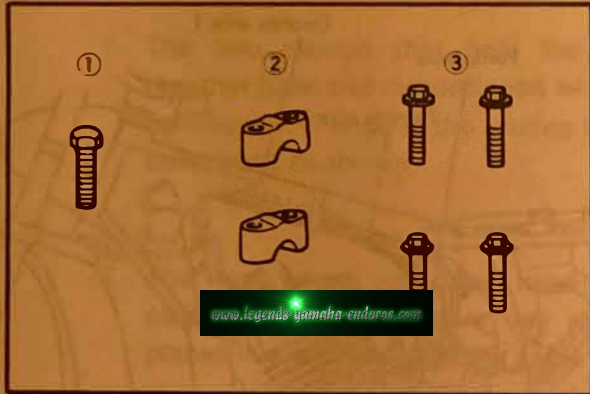

SET-UP PROCEDURES

NOTE:

This model is designed upon the DT100D but built as an off-road machine like the YZ series machine, so the headlight, speedometer, flasher lights, taillight, and battery are removed. When assembling this model, refer to the DT100D (90894-07620) (LIT-11666-00-36) Assembly Manual.

CABLE ROUTING DIAGRAM

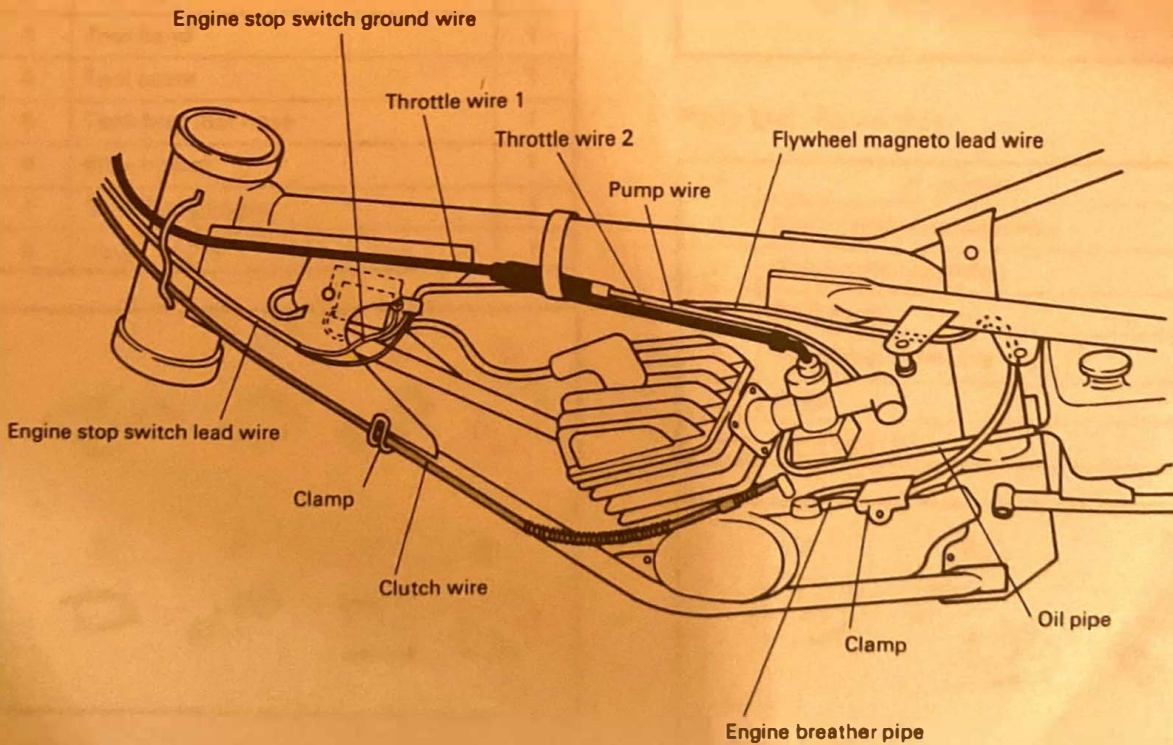
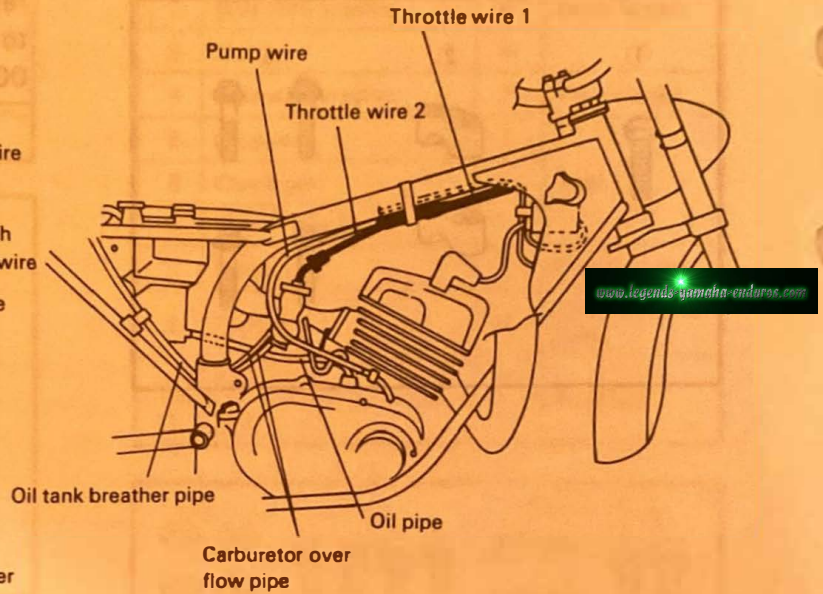
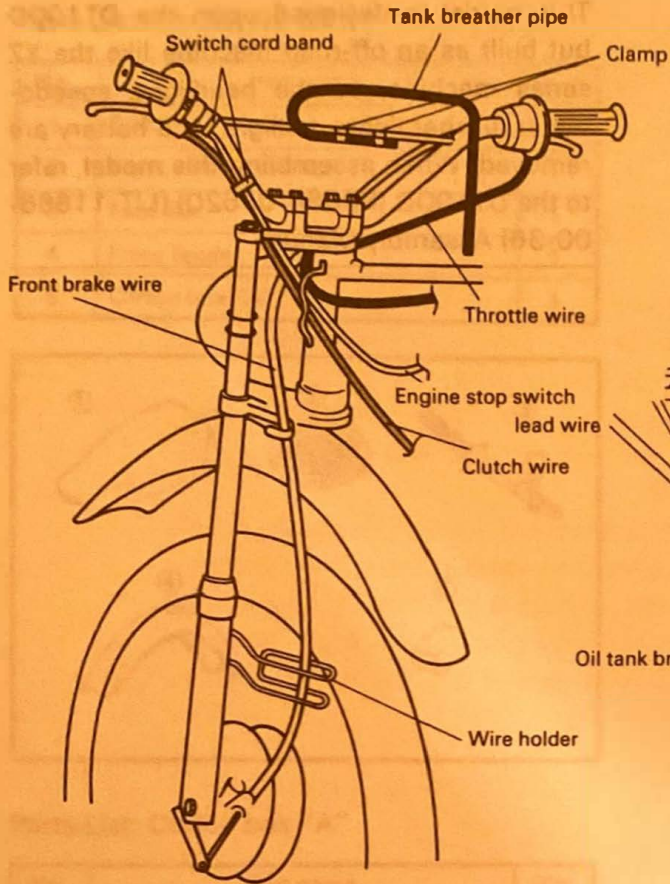

MX100G SUPPLEMENTARY ASSEMBLY MANUAL

There is no particular difference in assembly between the MX100G (90894-07914) (LIT-11666-01-70) and MX100F (90894-07841) (LIT-11666-01-63) except that the following three minor points are changed as opposed to the "F" model.

1. The two clamps that held the tank breather hose and discontinued with the consequent change in the routing of the same hose as shown.
2. The front wheel collar that used to be placed bare on the foam tray is now placed in a vinyl bag on the same base
3. Following the discontinuation of the tank breather pipe clamps as mentioned above and the adoption of the CDI magneto, the cable routing diagram is changed.

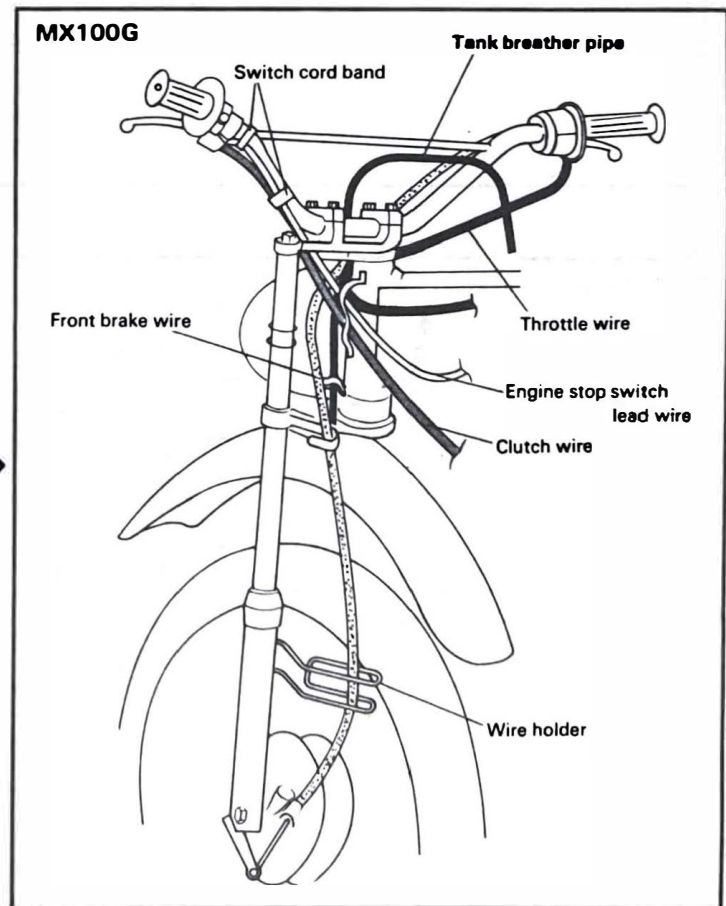
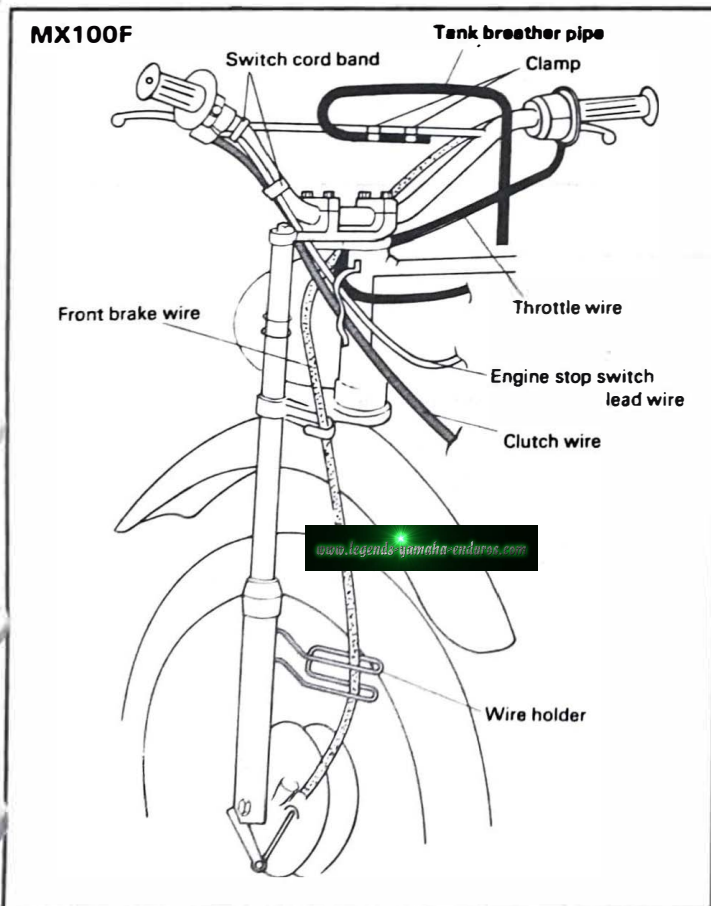
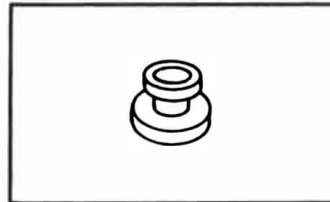
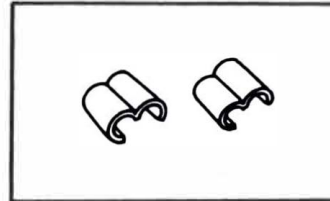

MX100F

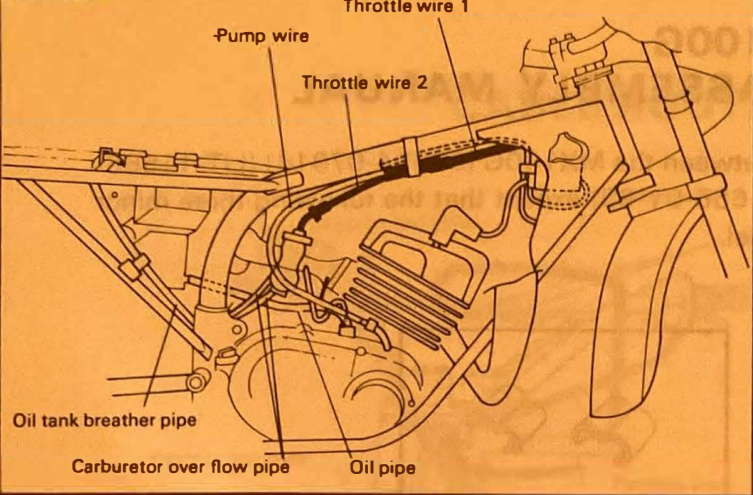

MX100G

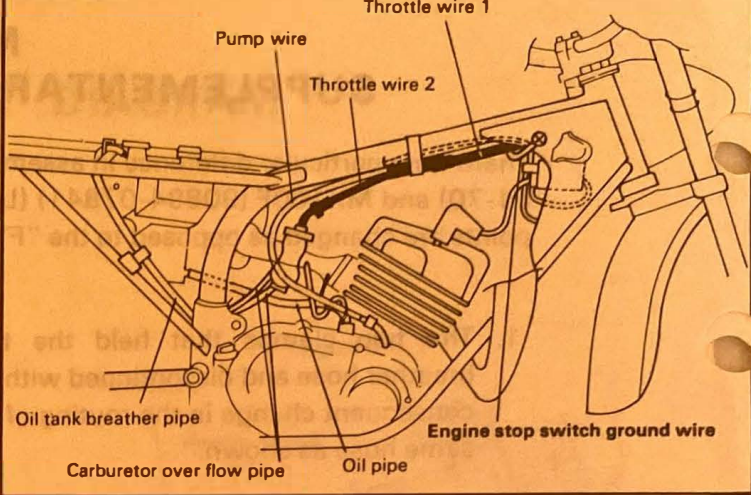

MX100F

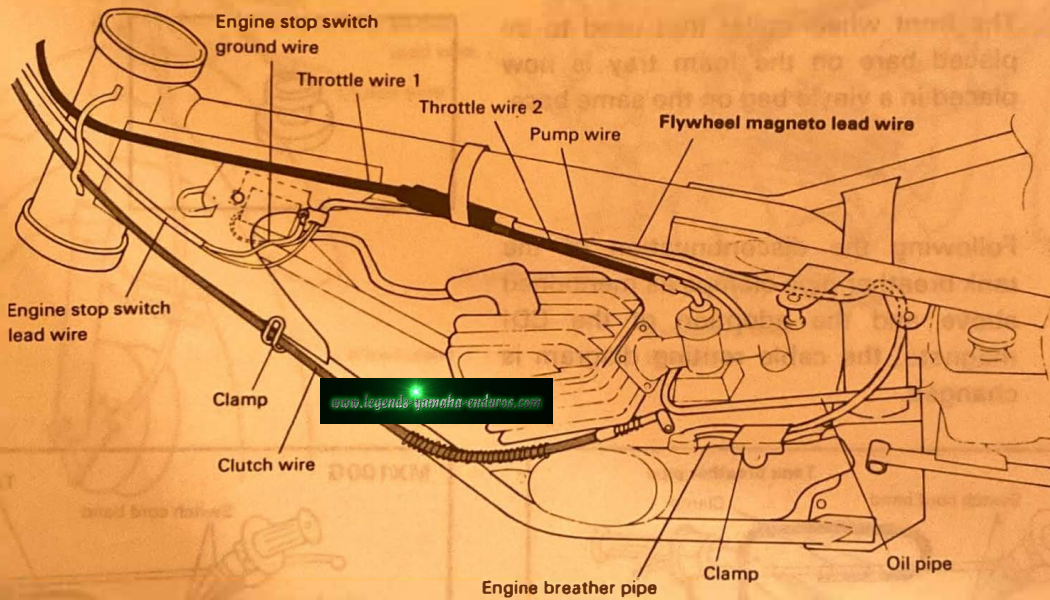

MX100G

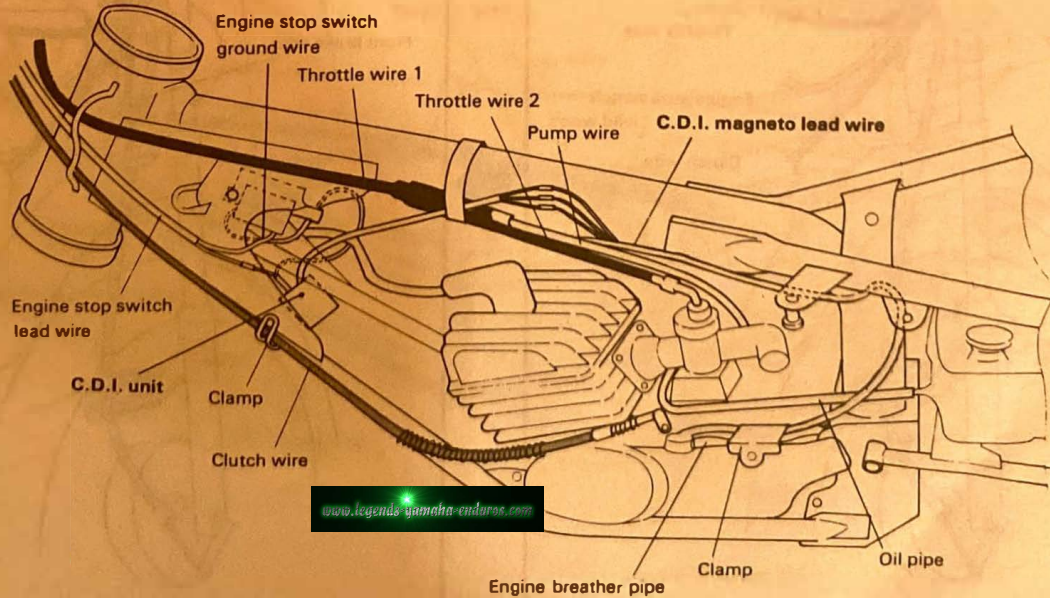

www.legends-yamaha-enduros.com



YAMAHA MOTOR CO.,LTD.