



YAMAHA

MX100J

OWNER'S SERVICE MANUAL

www.legends-yamaha-enduros.com

Particularly important information is distinguished in this manual by the following notations:

NOTE:

A NOTE provides key information to make procedures easier or clearer.

CAUTION:

A CAUTION indicates special procedures that must be followed to avoid damage to the machine.

WARNING:

A WARNING indicates special procedures that must be followed to avoid injury to a machine operator or person inspecting or repairing the machine.

MX100J

OWNER'S SERVICE MANUAL

© 1981 by Yamaha Motor Corporation, U.S.A.

1st. Edition, April 1981

**All rights reserved. Any reprinting or
unauthorized use without the written
permission of Yamaha Motor Corporation,
U.S.A., is expressly prohibited.**

Printed in Japan

P/LIT-11626-03-08

IMPORTANT NOTICE

THIS MOTORCYCLE IS DESIGNED STRICTLY FOR OFF-ROAD RIDING USE ONLY. IT IS ILLEGAL TO OPERATE THIS VEHICLE ON PUBLIC STREETS; ROADS; AND HIGHWAYS. PLEASE CHECK LOCAL RIDING LAWS AND REGULATIONS BEFORE OPERATING THIS VEHICLE.

SAFETY WARNINGS:

- 1. GASOLINE IS HIGHLY FLAMMABLE:**
 - *Always turn off the engine when refuelling.**
 - *Take care not to spill on the engine or exhaust pipe/muffler, when refuelling.**
 - *Never refuel while smoking or in the vicinity of an open flame.**
- 2. If you should swallow some gasoline or inhale a lot of gasoline vapor, or allow some gasoline to get in your eye(s), see your doctor immediately. If any gasoline spills on your skin or clothing, immediately wash it with soap and water, and change your clothes.**

- 3. Always turn off the engine before leaving the machine unattended. When parking the machine, not the following:**
 - *The engine and exhaust pipe/muffler may be hot. Park the machine in a place where pedestrians or children are not likely to touch the machine.**
 - *Do not park the machine on a slope or soft ground; the machine may overturn.**
- 4. When transporting the machine in another vehicle, be sure it is kept upright and that the fuel petcock is turned to the "OFF" position. If it should lean over, gasoline may leak out of the carburetor or fuel tank.**
- 5. Never start your engine or let it run for any length of time in a closed area. The exhaust fumes are poisonous and may cause loss of consciousness and death within a short time. Always operate your machine in an area with adequate ventilation.**
- 6. Always wear a helmet, gloves, boots, trousers, and jacket for moto cross riding.**

This Owner's Service Manual is included to provide basic information for operation and maintenance. Additional information regarding major repairs, such as crankcase disassembly, can be found within the DT100D Service Manual (1T9-28197-10) and various other information and training manuals available from your Authorized Yamaha.

INTRODUCTION

Congratulations on your purchase of the Yamaha MX100J. This model represents the product of many years of Yamaha experience in the production of fine sporting, touring, and pace-setting racing machines. You can now appreciate the high degrees of craftsmanship and reliability that have made Yamaha a leader in these fields.

PLEASE READ THIS MANUAL CAREFULLY AND COMPLETELY BEFORE OPERATING YOUR NEW MACHINE. This manual will provide you with a good basic understanding of the features, operation, and basic maintenance and inspection items of this vehicle. If you have any questions regarding the operation or maintenance of your machine, please consult your Yamaha dealer.

NOTICE:

Some data in this manual may become outdated due to improvements made to this model in the future. If you have any question regarding this manual or your machine, please consult your Yamaha dealer.

**SERVICE DEPT.
INTERNATIONAL DIVISION
YAMAHA MOTOR CO., LTD.**

CONTENTS

DESCRIPTION	1
MACHINE IDENTIFICATION	2
CONTROL FUNCTIONS	3
PRE-OPERATION CHECKS.....	7
OPERATION	9
PERIODIC MAINTENANCE AND ADJUSTMENTS	12
MINOR REPAIRS.....	30
CABLE ROUTING	51
CLEANING AND STORAGE	56
SPECIFICATIONS	59
WARRANTY INFORMATION.....	71

DESCRIPTION

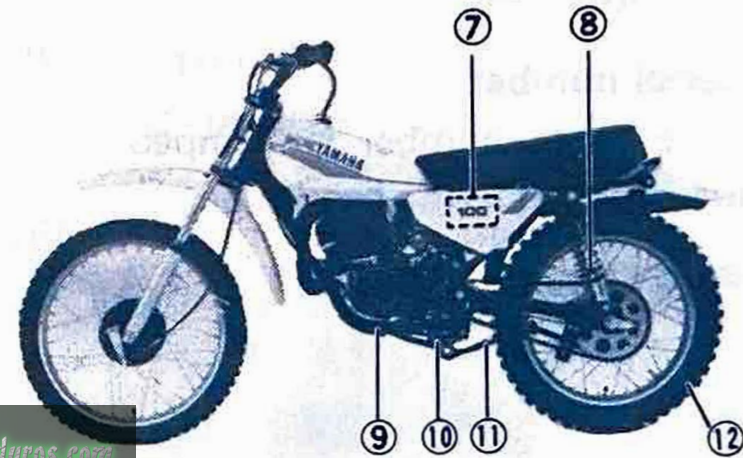
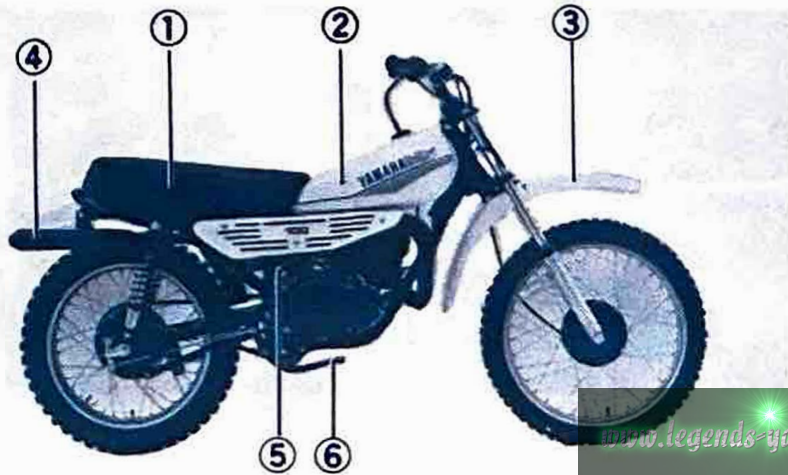

- | | |
|-----------------|------------------------|
| 1. Seat | 8. Rear shock absorber |
| 2. Fuel tank | 9. Change pedal |
| 3. Front fender | 10. Footrest |
| 4. Muffler | 11. Side stand |
| 5. Kick crank | 12. Rear wheel |
| 6. Brake pedal | 13. Clutch lever |
| 7. Oil tank | 14. Brake lever |
| | 15. Throttle grip |

MASCHINE IDENTIFICATION

Frame serial number

The frame serial number is stamped on the right side of the steering head pipe.

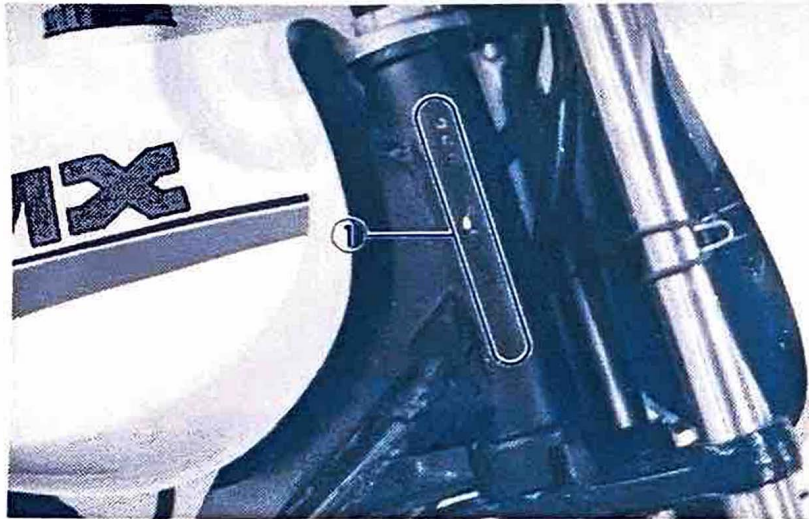

1. Frame serial number

Engine serial number

The engine serial number is stamped on the elevated part of the right rear section of the engine.

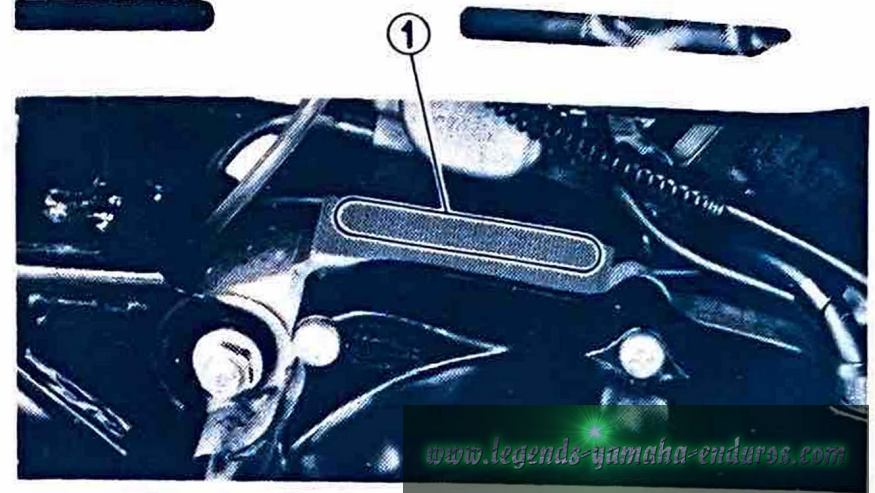

1. Engine serial number

NOTE: _____

The first three digits of these numbers are for model identification; the remaining digits are the unit production number.

Keep a record of these numbers for reference when ordering parts from your Yamaha dealer.

CONTROL FUNCTIONS

Engine stop button

The engine stop button is located on the left handlebar.

Push and hold to stop engine.

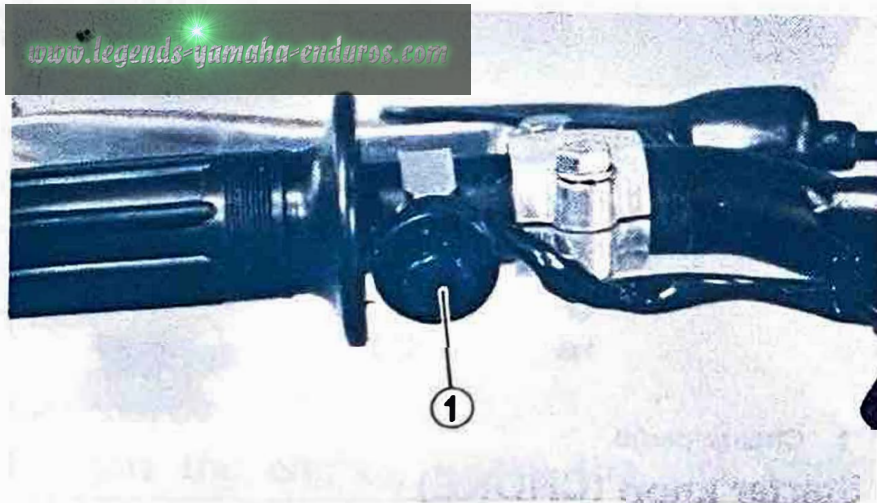

1. Engine stop button

Fuel petcock

The fuel petcock functions to supply fuel from the tank to the carburetor and also to filter the fuel.

The fuel petcock has the following three positions:

OFF: With the lever in this position fuel will not flow. Return the lever to this position when the engine is not running.

ON: With the lever in this position fuel flows to the carburetor. Normal riding is done with the lever in this position.

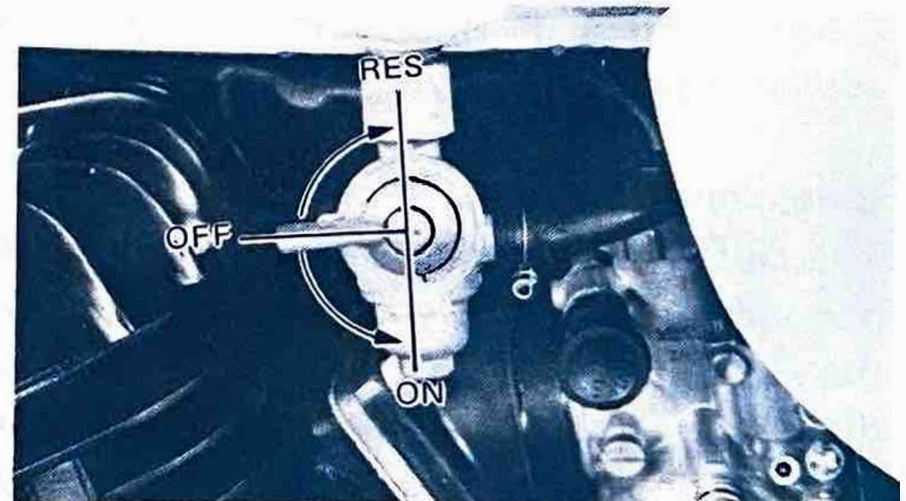

RES: This indicates "RESERVE". If you run out of fuel while riding, move the lever to this position. THEN, FILL THE TANK AT THE FIRST OPPORTUNITY.

Front brake lever

The front brake lever is located on the right handlebar, pull it toward the handlebar to activated the front brake.

Rear brake pedal

The rear brake pedal is on the right side of the machine. Press down on the brake pedal to activate the rear brake.

Clutch lever

The clutch lever is located on the left handlebar and disengages or engages the clutch. Pull the clutch lever to the handlebar to disengage the clutch and release the lever to engage the clutch. The lever should be pulled rapidly and released slowly for smooth starts.

Change pedal

The gear ratios of the constant mesh 5-speed transmission are ideally spaced. The gears can be shifted by using the change pedal on the left side of the engine.

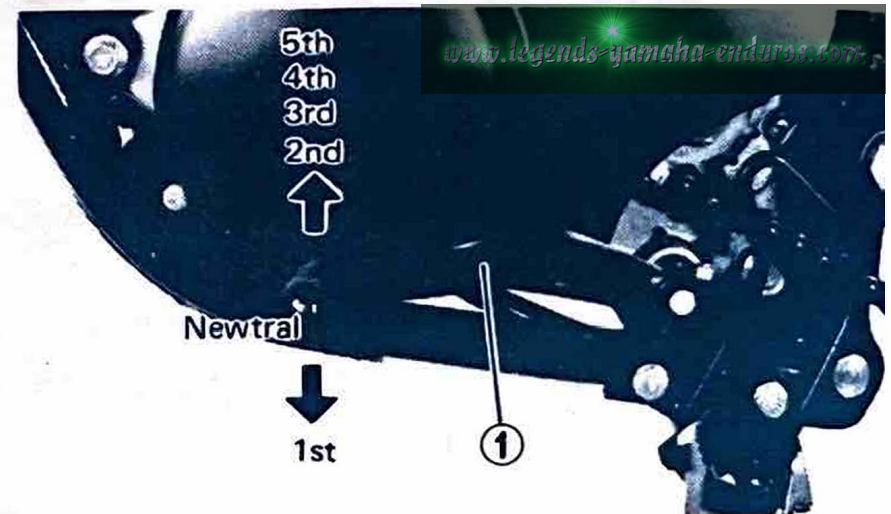

1. Change pedal

Starter knob (CHOKE)

When cold, the engine requires a richer fuel mixture for starting. A separate starter circuit, which is controlled by the starter knob, supplies this mixture.

Pull the knob out to open the circuit (for starting) and push the knob in to close the circuit before riding.

See "Starting Instructions" before attempting to start the engine.

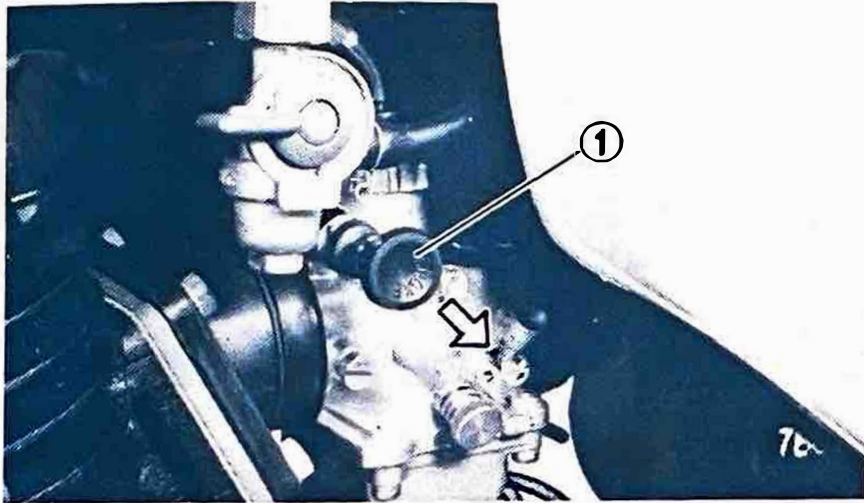

1. Starter knob

Kick starter

To start the engine, rotate the kick crank, push down lightly with foot until gears engage, and then kick with full strength. This model has the primary kick starter so the engine can be started in any gear if the clutch is disengaged. As normal practice, however, shift to neutral before starting.

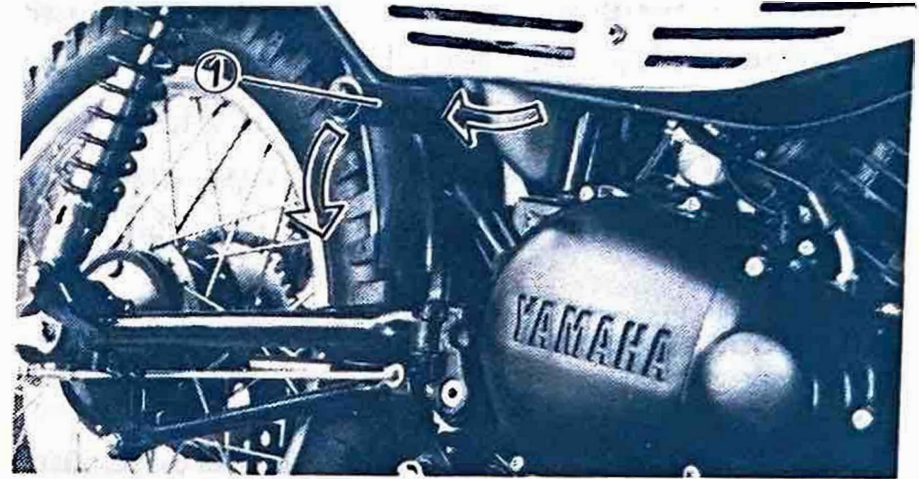

1. Kick crank

Seat latch

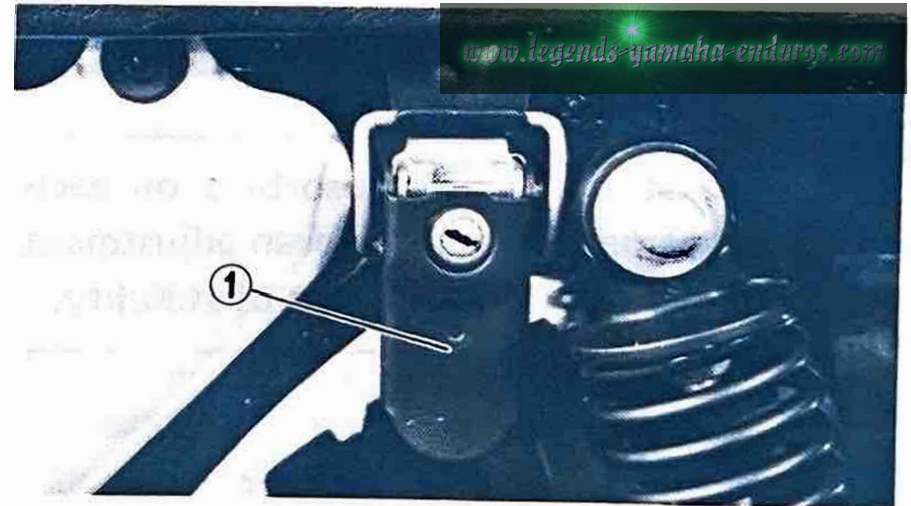

1. Seat latch

The seat is hinged to the frame on one side and secured by the seat latch on the other side. To add engine oil, or take out the service tools, pull the seat latch lever out, free the seat latch from the hook and lift the seat.

Rear shock absorber

The spring preload of the rear shock absorber can be adjusted to suit rider preference and riding conditions.

If the spring seat is raised, the spring becomes stiffer and if lowered the spring becomes softer.

WARNING:

Always adjust the shock absorbers on each side to the same position. Uneven adjustment can cause poor handling and loss of stability.

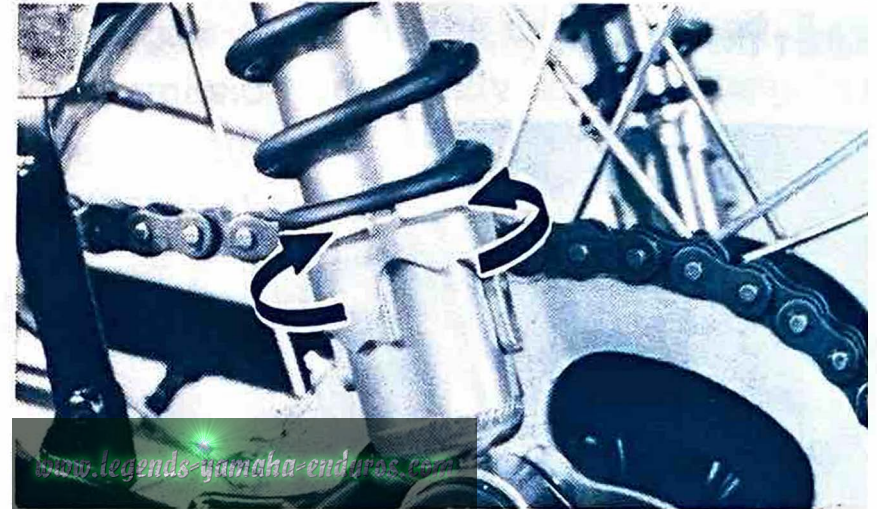

PRE-OPERATION CHECKS

Before using this motorcycle please check the following points:

Item	Routine	Page
Brakes	Check operation/adjustment	24, 25
Clutch	Check operation/lever adjustment	23, 24
Fuel tank	Check fuel level/top-up as required	8
Engine oil	Check oil level/top-up as required	16
Transmission oil	Check oil level/top-up as required	17
Drive chain	Check alignment/adjustment/lubrication	25 ~ 28
Spark plug	Check color/condition	18
Throttle	Check for proper throttle and Autolube cable operation	20
Air filter	Foam type – must be clean and damp with oil always	19, 20
Wheels and tires	Check tire pressure/wear	9, 47 ~ 49
Fittings/fasteners	Check all – tighten as necessary	—

NOTE:_____

Pre-operation checks should be made each time the machine is used. Such an inspection can be thoroughly accomplished in a very short time; and the added safety it assures is more than worth the time involved.

Brake (Front and Rear)

Check for correct play in the brake lever and pedal and make sure they are working properly. Check the brakes at low speed shortly after starting out. If the play is incorrect, make an adjustment.

Clutch

Check for correct play in the clutch lever and make sure the lever operates properly.

If the play is incorrect, make an adjustment.

Engine oil (oil tank)

Make sure there is sufficient engine oil in the oil tank. Add oil as necessary.

Recommended oil: (See page 16)
Yamalube 2-cycle oil or
air cooled 2-cycle engine oil
Oil tank capacity: 1.0 lit (1.1 US.gal)

Transmission oil

Make sure the transmission oil is at the specified level. Add oil as necessary.

Recommended oil: (See page 17)
Yamalube 4-cycle oil or
SAE 10W/30 type "SE" motor oil
Oil quantity:
650 ± 50 cc (0.7 ± 0.05 US.qt)

Fuel

Make sure there is sufficient fuel in the tank.

Recommended fuel: Regular gasoline
Fuel tank capacity: 4.5 lit (1.2 US.gal)

Tires

Check the tire pressure and check the tires for wear.

Tire pressure

Front	1.0 kg/cm ² (14 psi)
Rear	1.2 kg/cm ² (18 psi)

Throttle grip

Turn the throttle grip to see that it operates properly and that the play is normal. Make certain the throttle springs are closed when released. Adjust if necessary.

Engine stop switch

Start the engine and make sure the engine stop switch functions properly.

OPERATION AND IMPORTANT RIDING POINTS

CAUTION:

Before riding this motorcycle, become thoroughly familiar with all operating controls and their function. Consult your Yamaha dealer regarding any control or function you do not thoroughly understand.

NOTICE:

This model is not equipped with highway approved lighting. This model is designed solely for off-road riding use and should not be used on a street or highway at any time. In most instances, it is illegal to drive this model on any public street or highway.

Starting a cold engine

1. Turn the fuel petcock to "ON".
2. Operate the carburetor starter (choke) knob and completely close the throttle grip.
3. Kick the kick crank with full strength to start the engine.
4. After the engine starts, warm up for one or two minutes. Make sure the starter (choke) knob is returned to the original position before riding.

Starting a warm engine

To start warm engine, the starter knob is not required.

CAUTION:

See "Break-in Section" prior to operating engine for the first time.

WARNING:

Before starting out, always be sure the side stand is up. Failure to retract the side stand completely can result in a serious accident when you try to turn a corner.

Warming up

To get maximum engine life, always "warm-up" the engine before starting off. Never accelerate hard with a cold engine! To see whether or not the engine is warm, see if it responds to throttle normally with the starter (choke) turned off.

Engine break-in

There is never a more important period, in the life of your machine, than the period between zero and 20 hour.

For this reason we ask that you carefully read the following material. Because the engine is brand new, you must not put an excessive load on it for the first several hours of run-

ning. During the first 20 hour the various parts in the engine wear and polish themselves to the correct operating clearances. During this period prolonged full throttle operation, or any condition which might result in excessive heat of cylinder, must be avoided. However, momentary full throttle operation, under load (2 ~ 3 seconds maximum), does not harm the engine.

Each full throttle acceleration sequence should be followed with a substantial rest period for the engine by cruising at lower r.p.m.'s so the engine can rid itself of the temporary build up of heat.

If any abnormality is noticed during this period, ask your Yamaha dealer to check.

1. **Initial break-in:**
Avoid continuous operation above half throttle. Allow a cooling off period of five to ten minutes after every hour of operation. Vary the speed of machine from time to time. Do not operate it at one set, throttle position.
2. **Intermediate:**
Avoid prolonged operation above 3/4 throttle. Allow the machine to rev freely through the gears but do not use full throttle at any time.
3. **After break-in:**
Avoid prolonged full throttle operation. Vary speeds occasionally.

PERIODIC MAINTENANCE AND ADJUSTMENTS

Periodic inspection, adjustment and lubrication will keep your machine in the safest and most efficient condition possible. Safety is an obligation of the machine owner. The most important points of machine inspection, adjustment and lubrication and explained on the following pages.

CAUTION:

If the owner is not familiar with machine service, this work should be done by a Yamaha dealer.

Tool kit

The servicing information included in this manual is intended to provide you, the owner, with the necessary information for completing your own preventive maintenance and minor repairs. The tools provided in the owner's tool kit are sufficient for this purpose, except that a torque wrench is also necessary to properly tighten nuts and bolts.



1. Tool kit

Lubrication Intervals

www.legends-yamaha-enduros.com

Page	Item	Remarks	Type	Initial (hour)				Thereafter every (hour)		
				10	20	40	80	40	80	160
17	Transmission oil change	Warm engine before draining	No. 1		○	○			○	
25 ~ 28	Drive chain	Lube/Adjust as required	No. 2	See notes						
25 ~ 28	Drive chain	Remove/Clean/Lube/Adjust	No. 2			○		○		
20	Control cables	All-apply thoroughly	No. 2			○	○		○	
20	Throttle grip and housing	Light application	No. 3				○		○	
—	Brake pedal shaft	Light application	No. 3			○			○	
—	Change pedal shaft	Light application	No. 3			○			○	
—	Stand shaft pivot(s)	Light application	No. 3			○			○	
29, 30	Front forks	Drain completely	No. 5				○		○	
Dealer	Steering ball races	Inspect thoroughly/Pack	No. 4				○			○
49	Wheel bearings	Do not over-pack	No. 4				○		○	

Recommended lubricant type

1. Use Yamalube 4-cycle oil or SAE 10W/30 type "SE" motor oil.
2. Use Yamaha chain and cable lube or SAE 10W/30 motor oil. (If desired, specialty type lubricants of quality manufacture may be used.)
3. Use lithium base grease.
4. Medium-weight wheel bearing grease of quality manufacture—preferably waterproof.
5. Use Yamaha fork oil 10 wt or equivalent.

NOTE: _____
Drive chain must be lubricated every 0.5 ~ 1.0 hour. If unit is subjected to extremely hard use, chain must be inspected frequently and serviced as required.

www.legends-yamaha-enduros.com

Periodic Maintenance Intervals

Page	Item	Remarks	Initial (hour)				Thereafter every (hour)	
			10	20	40	80	40	80
24, 25	Brake system (complete)	Check/Adjust as required—repair as required		○	○		○	
23, 24	Clutch	Check/Adjust as required		○	○		○	
17, 18	Spark plug	Inspect/Clean or replace as required	○	○	○		○	
44 ~ 49	Wheels and tires	Pressure/Runout/Spoke—tension	○	○	○		○	
—	Fittings and fasteners	Tighten before each trip and/or	○	○	○		○	
25 ~ 28	Drive chain	Tension/Alignment (No. 1)	○	○	○		○	
19	Air filter	Wet type—clean/Replace as required (No. 2)		○	○	○	20	
22, 23	Fuel petcock	Clean/Flush tank as required	○		○		○	
19	Ignition timing	Clean or replace parts as required				○		○
30 ~ 34	Carburetor adjustment	Check operation/Timings		○	○	○		○
Dealer	Carburetor overhaul	Clean/Repair as required/Refit/Adjust						160
Dealer	Cylinder compression	Preventive maintenance check		○	○	○		○
—	Decarbonize engine	Includes exhaust system			○			○

SERVICE NOTES:

No. 1. **DRIVE CHAIN:** In addition to tension and alignment, chain must be lubricated every 0.5 ~ 1.0 hour. If unit is subjected to extremely hard usage and wet weather riding, chain must be checked constantly. See "Lubrication Intervals" for additional details.

No. 2. **AIR FILTER:** Remove and clean filter every 10 ~ 20 hours.

Engine oil (Autolube oil)

We recommended Yamalube 2-cycle oil (available at most Yamaha dealers) but, if other oils are used, use air cooled 2-stroke engine oil.

NOTE: _____

Oil viscosity increases in very cold weather [where the normal temperature is below 0°C (30° F)] and oil does not flow as well. In such areas, consult your Yamaha dealer.

Oil tank capacity: 1.0 lit (1.1 US.qt)



1. Oil tank filler cap

NOTE: _____

Install the oil tank filler cap and push it fully into the filler.

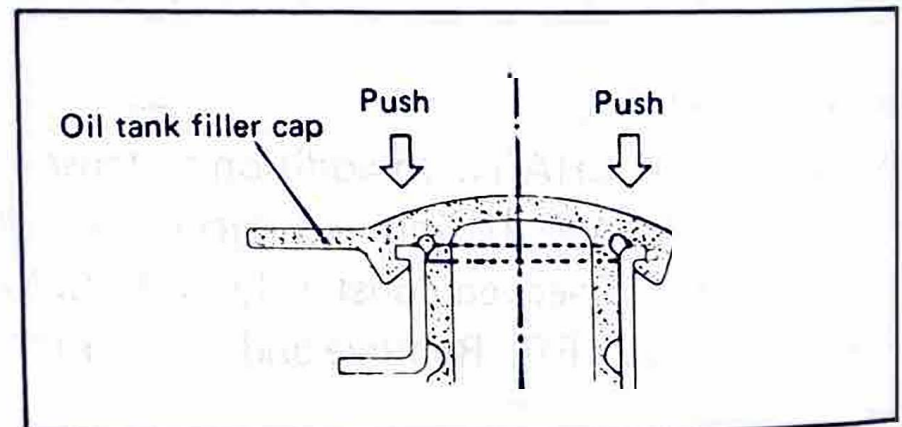

Transmission oil

Recommended oil:

Yamalube 4-cycle oil or
SAE 10W/30 "SE" motor oil

OIL LEVEL CHECK

To check, warm up the engine for 2 ~ 3 minutes. Place the machine upright and remove the dipstick completely and just reset the dipstick in the hole.

If the level is lower, add sufficient oil to raise it to proper level.

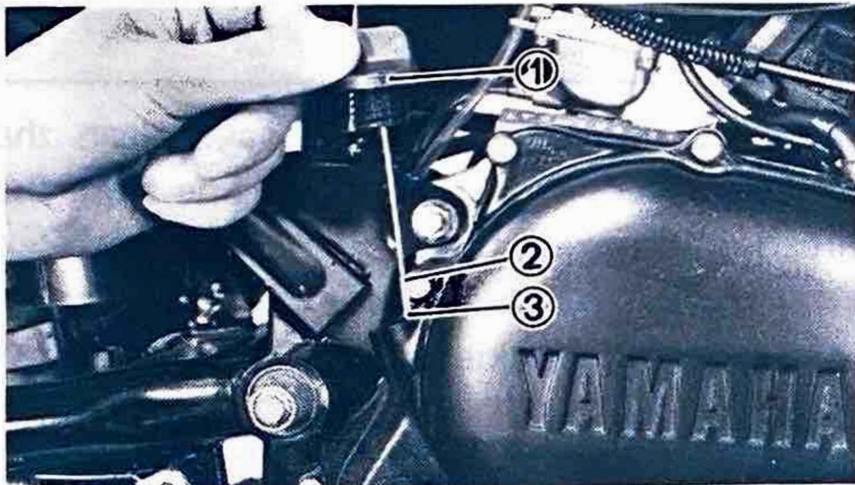

1. Dipstick 2. Maximum level 3. Minimum level

Transmission oil capacity:

650 ± 50 cc (0.7 ~ 0.05 US.qt)

OIL REPLACEMENT

To drain the oil, warm the engine up and remove the drain plug and drain all transmission oil. Reinstall the drain plug (make sure it is secure). Add oil through the dipstick hole.

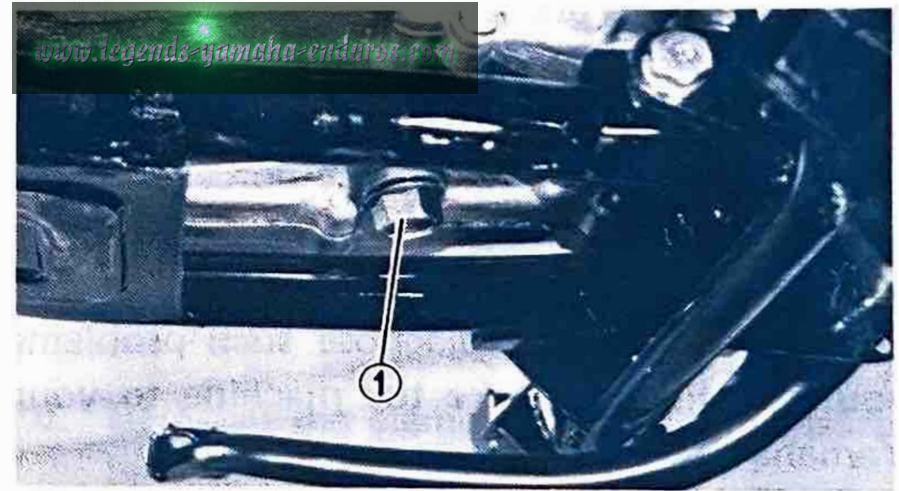

1. Drain plug

Spark plug inspection

The spark plug is an important engine component and is easy to inspect.

You should periodically remove and inspect the spark plug because heat and deposits will cause any spark plug to slowly break down and erode. If electrode erosion becomes excessive, or if carbon and other deposits are excessive, you should replace the spark plug with one of the proper type.

The condition of the spark plug reflects the running condition of the engine. For example, a very white center electrode porcelain color could indicate an intake tract air leak or carburetion problem.

Do not attempt to diagnose such problems yourself. Instead, take the machine to your Yamaha dealer.

Standard spark plug: B7ES (NGK)

Before installing any spark plug, measure the plug gap with a wire thickness gauge and adjust to specifications.

Spark plug gap:

0.5 ~ 0.6 mm (0.020 ~ 0.024 in)

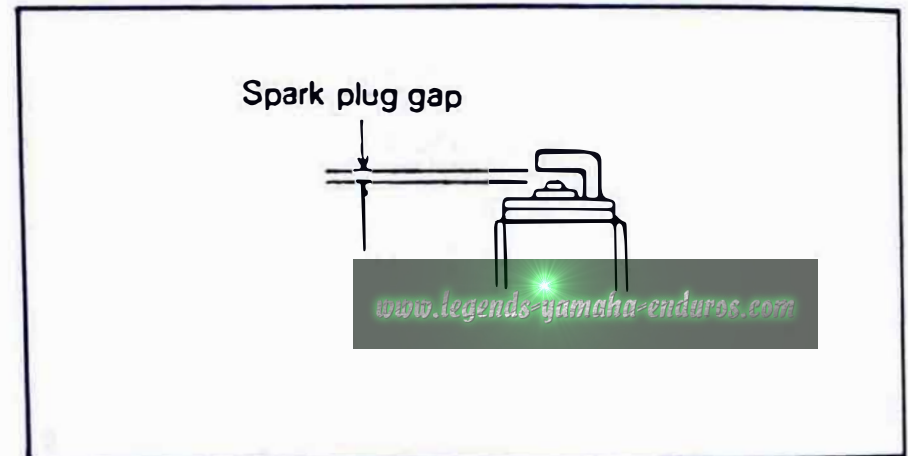

When installing the plug, always clean the gasket surface. Wipe off any grime from the threads and torque the spark plug properly.

Spark plug torque: 2.5 m·kg (18 ft·lb)

Ignition timing

This model uses the CDI system, and therefore no ignition timing adjustment is necessary. If any irregularity in the ignition system is found, refer to the "Troubleshooting" or consult your Yamaha dealer.

Air filter cleaning

1. Wash the element gently, but thoroughly, in solvent.
2. Squeeze the excess solvent out of the element and let dry.
3. Pour a small quantity of Yamalube 2-cycle oil onto the filter element and work thoroughly into the porous foam material.

NOTE: _____

In order to function properly, the element must be damp with oil at all times, but not dripping with oil.

4. Re-insert the filter element guide into the element.
5. Coat the sealing edges of the filter element with light grease. This will provide an air-tight seal between the filter case cover and filter seat.



6. Reinstall the element assembly and parts removed for access.

NOTE:

Each time filter element maintenance is performed, check the air inlet to the filter case for obstructions. Check the air cleaner joint rubber to the carburetor and manifold fittings for an air-tight seal. Tighten all fittings thoroughly to avoid the possibility of unfiltered air entering the engine.

CAUTION:

Never operate the engine with the air filter element removed. This will allow unfiltered air to enter, causing rapid wear and possible engine damage. Additionally, operation without the filter element will affect carburetor jetting with subsequent poor performance and possible engine overheating.

CARBURETOR

Throttle cable adjustment

Check play in turning direction of throttle grip. The play should be 5 ~ 7 mm (0.20 ~ 0.28 in) at grip flange, loosen the lock nut and turn the wire adjuster to make the necessary adjustment. Tighten the adjuster lock nut.

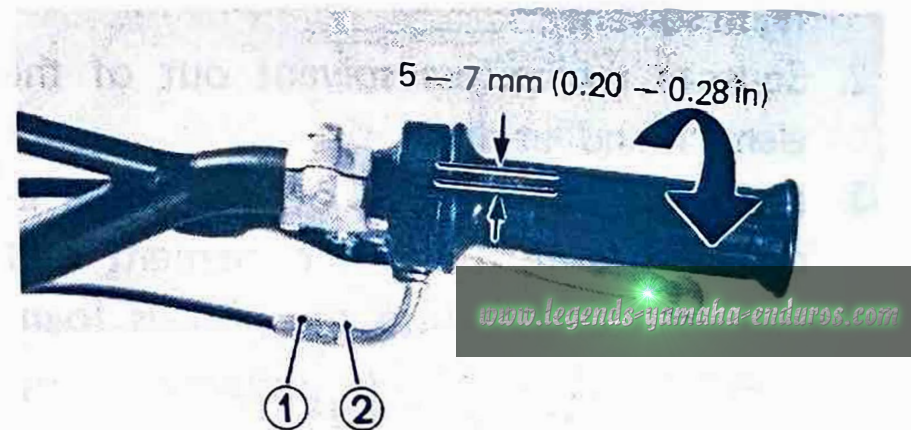

1. Adjuster 2. Lock nut

Idling speed adjustments

1. Turn pilot air screw in until lightly seated.

2. Back out 1 and 1/2 turns. Start the engine and warm it up.

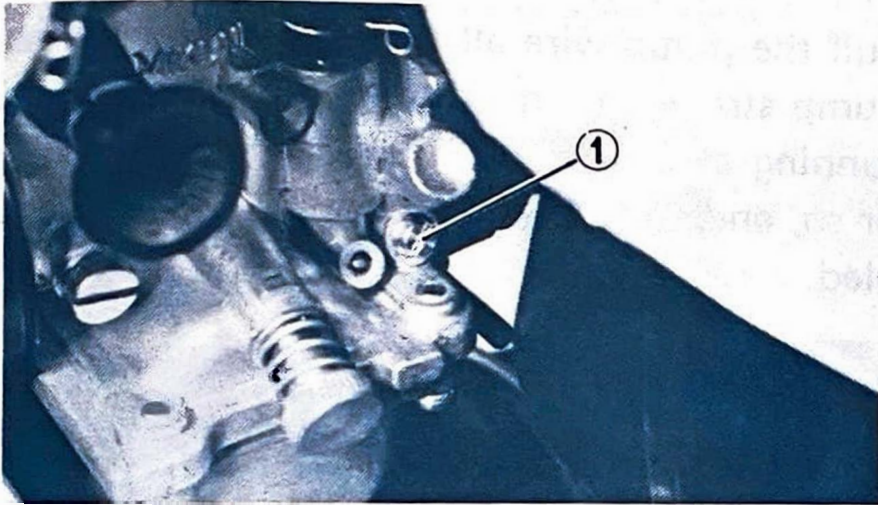

1. Pilot air screw

Pilot air screw: Back out 1 and 1/2 turns

3. Turn the throttle stop screw until idle is at desired r/min.
4. Turn the pilot air screw in or out until idle speed is at higher r/min.
5. Turn the throttle stop screw in or out until idle speed is at desired r/min.

Idle speed: As desired



1. Throttle stop screw

NOTE:

Pilot air and throttle stop screws should be adjusted so that engine response from idle position is rapid and without hesitation.

Autolube pump cable adjustment

Close the throttle grip completely, then twist it open until all cable slack is removed, but

stop before the slides start to lift.

Adjust the pump cable so the mark (▶) on the pump pulley lines up with the "adjust pulley guide pin". The Autolube cable adjuster is located at the bottom end of the cable, screwed into the top of the right case cover.

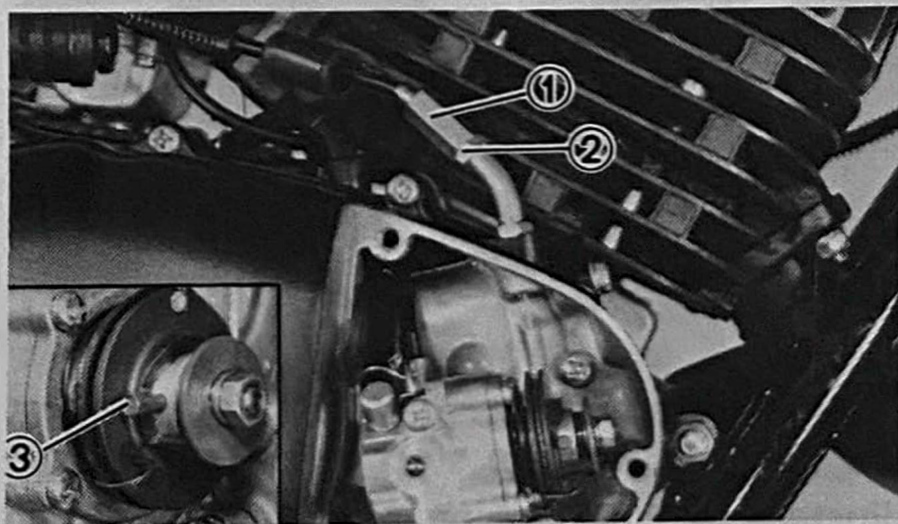

1. Adjuster 2. Lock nut 3. Guide pin

Bleeding the Autolube pump

If the pump runs out of oil, the pump must be bled to release air trapped in the pump.

Remove the bleed screw and keep the oil running out until air bubbles disappear.

Tighten the bleed screw. Start the engine and pull the pump wire all the way out to set the pump stroke to a maximum. Keep the engine running at about 2,000 r/min for 2 minutes or so, and Autolube pump can be completely bled.

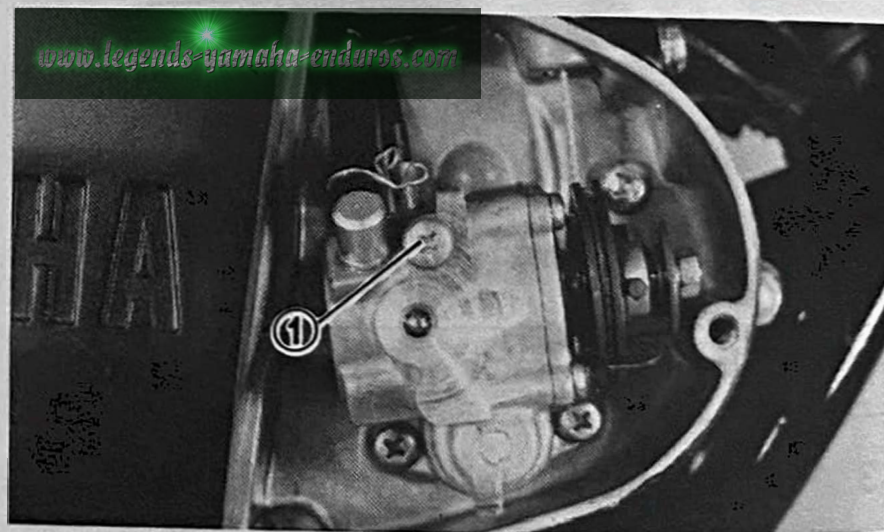

1. Bleed screw

Fuel petcock inspection and cleaning

The fuel petcock has a built-in to remove any particules before they reach the carburetor. If

the filter becomes blocked, the fuel cannot enter the carburetor. To prevent this, inspection and cleaning should be done at recommended intervals.

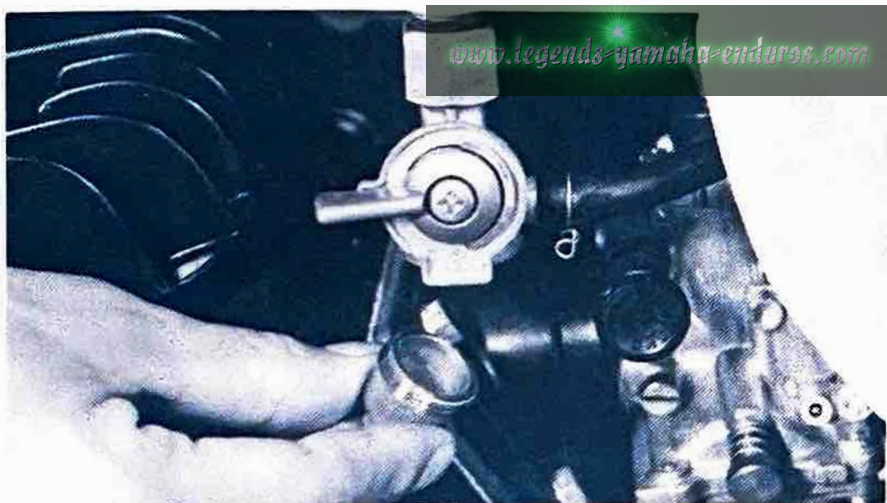

1. First, turn the petcock lever to the "OFF" position; then remove the filter cup and clean the bottom of the cup with solvent.
2. After removing the filter cup, remove and clean the filter screen. At the same time, you should examine the condition of the filter gasket. Replace if damaged.

3. When reassembling, be careful not to clamp the filter cup too tightly as this may cause the filter gasket to become unseated, resulting in fuel leakage.

Clutch adjustment

This model has two clutch cable length adjusters and an internal mechanism adjuster. Normally, once the mechanism is properly adjusted, the only adjustment required is maintenance of free play at the clutch handle lever.

1. **Free play adjustment**

Loosen either the handle lever adjuster lock nut or the cable in-line length adjuster lock nut. Next, turn the length adjuster either in or out until proper lever free play is achieved.

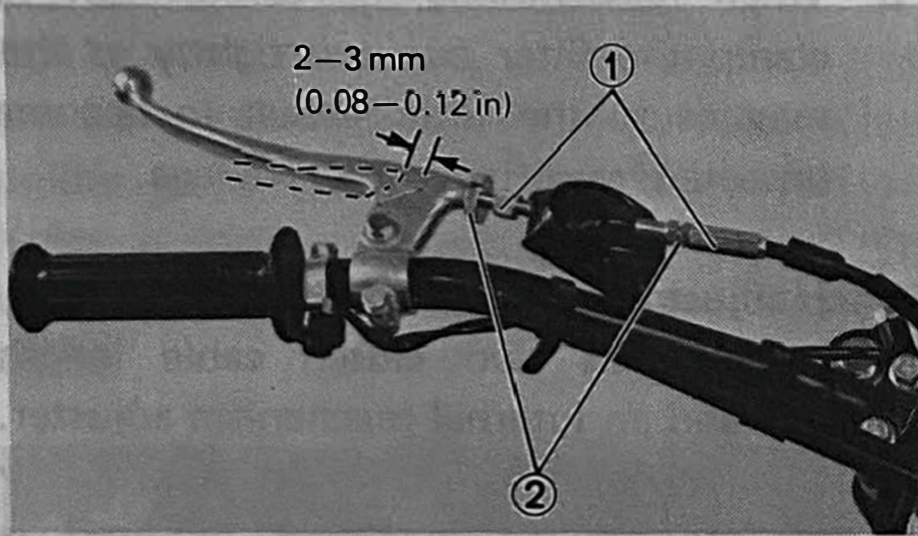

1. Adjuster 2. Lock nut

2. Mechanism adjustment

- a. Loosen the lock nut and fully tighten the adjuster.
- b. Remove left side crankcase cover and loosen adjuster lock nut.
- c. Slowly tighten the adjusting screw until resistance is felt. This means that the play of the push rod is removed. Then, back it off 1/4 turn. Tighten the lock nut.
- d. Adjust the lever free play.

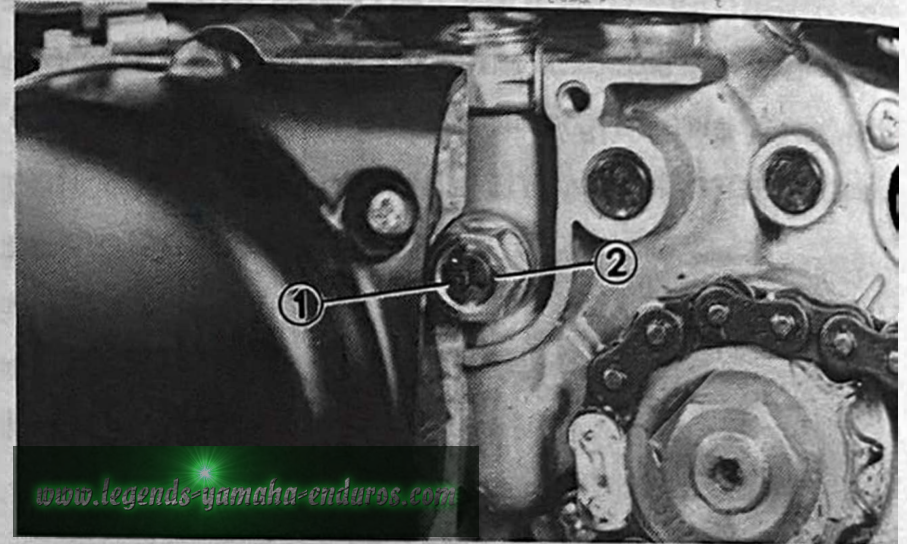

1. Adjuster 2. Lock nut

Front brake adjustment

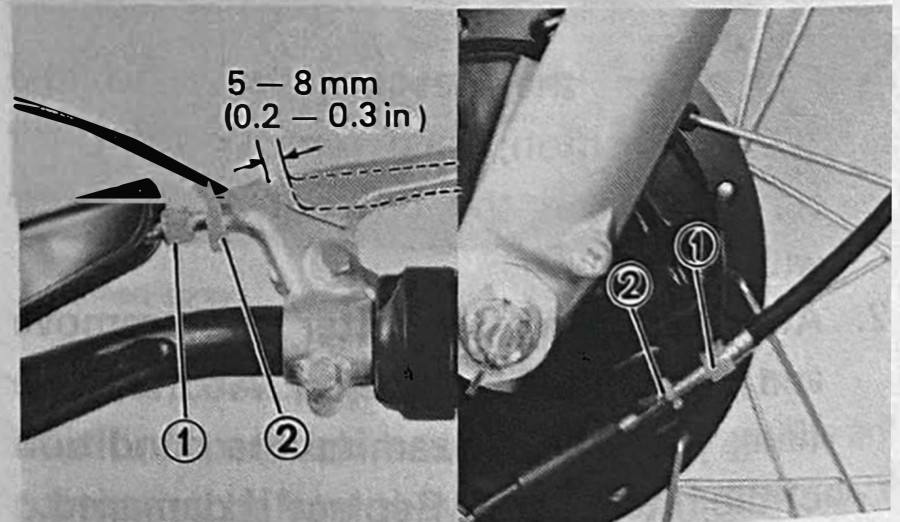

1. Adjuster 2. Lock nut

The front brake can be adjusted in two ways; (1) using the adjust screws at the front brake lever or (2) at the front brake shoe plate. Adjustment at the front brake lever is normally recommended. Loosen the lock nut and turn the adjuster to adjust the brake lever. As shown in the illustration, the clearance between the brake lever and the brake lever holder should be 5 ~ 8 mm (0.2 ~ 0.3 in). After adjusting, be sure the lock nut is tightened firmly. Ask a Yamaha dealer to make an adjustment at the brake shoe plate when all lever adjustment has been used.

Rear brake adjustment

The rear brake should be adjusted so the end of the brake pedal moves 20 ~ 30 mm (0.8 ~ 1.2 in). To adjust, turn the adjuster nut on the brake rod clockwise to reduce play; turn the nut counterclockwise to increase play.

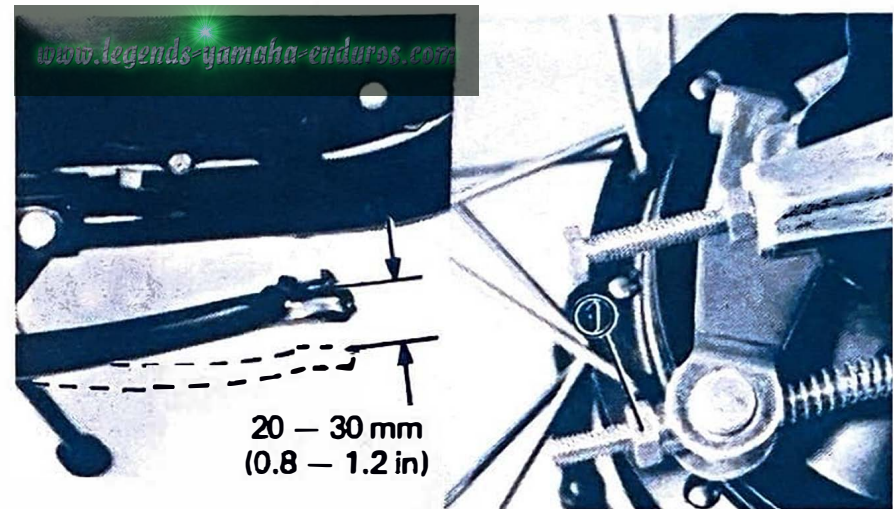

1. Adjuster

Drive chain tension check

To check the chain play, the machine must stand vertically with its both wheels on the ground and without passenger on it.

Then measure the play at the bottom of the chain at a point midway between the drive and driven sprockets.

The normal vertical deflection is approximately 20 ~ 30 mm (0.8 ~ 1.2 in). If the chain deflection is not as specified, adjust the chain tension.

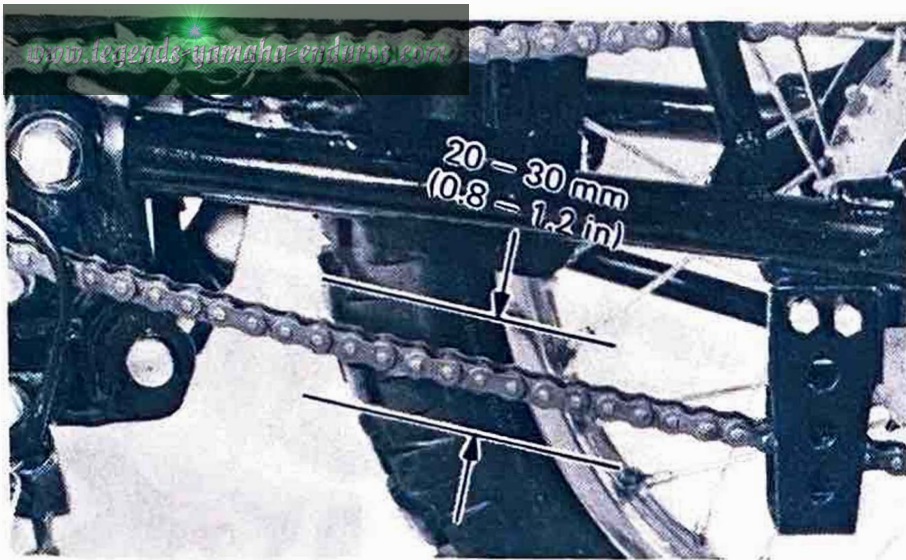

Drain chain tension adjustment

1. Loosen the rear brake rod adjuster.
2. Remove the cotter pin from the rear wheel axle nut with pliers.
3. Loosen the rear wheel axle nut and sprocket shaft nut.
4. Loosen the adjusting bolt lock nut. To tighten chain, turn chain puller adjusting bolt clockwise. To loosen chain, turn adjusting bolts counterclockwise and push wheel forward. Turn each bolt exactly the same amount to maintain correct axle alignment. (There are marks

on each side of rear arm and on each chain puller; use them to check for proper alignment.)

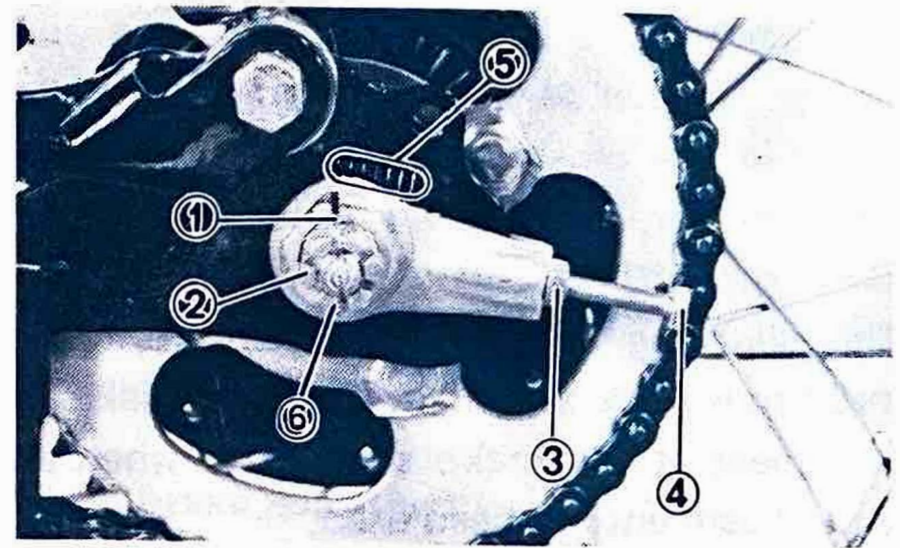

- | | |
|------------------------|------------------------|
| 1. Cotter pin | 4. Adjusting bolt |
| 2. Rear wheel axle nut | 5. Marks for alignment |
| 3. Lock nut | 6. Sprocket shaft nut |

NOTE: _____
 Before adjusting, rotate rear wheel through several revolutions and check tension several times to find the tightest point. Adjust chain tension with rear wheel in this "tight chain" position.

5. After adjusting, be sure to tighten the lock nut, sprocket shaft nut and rear wheel axle nut.

Tightening torque: 4.0 m-k (29 ft-lb)

Sprocket shaft nut:
11.0 m-k (80.0 ft-lb)

6. Also tighten the adjusting bolts against the rear arm (about 1/4 turn each).
7. Insert the cotter pin into the rear wheel axle nut and bend the cotter pin end as shown in the illustration (if the nut notch and the cotter pin hole do not match, tighten the nut slightly to match).

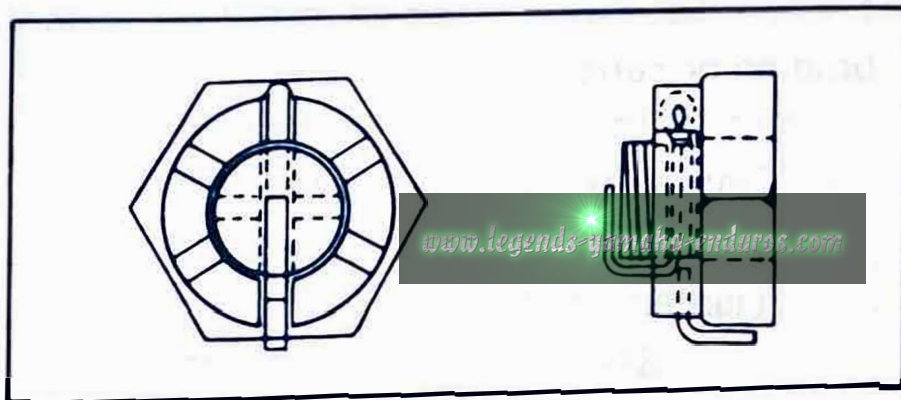

8. In the final step, adjust the play in the brake pedal.

CAUTION:

Excessive chain tension will overload the engine and other vital parts; keep the tension within the specified limits. Also, replace the rear axle cotter pin with a new one.

Drive chain lubrication

The chain consists of many parts which work against each other. If the chain is not maintained properly, it will wear out rapidly. Without lubrication the chain could wear out. This service is especially necessary when riding in dusty conditions.

1. Use any of the many brands of spray type chain lubricant. First, remove dirt and mud from the chain with a brush or cloth and then spray the lubricant between both rows of side plates and on all center rollers. This should be performed every 0.5 ~ 1.0 hour.
2. To clean the entire chain, first remove

the chain from the machine, dip it in solvent and clean out as much dirt as possible. Then take the chain out of the solvent and dry it. After drying, lubricate the chain to prevent the formation of rust.

Steering inspection

Periodically inspect the condition of the steering. Worn out or loose steering bearings may be dangerous.

Place a block under the engine to hold the front wheel of the motorcycle off the ground; then hold the lower end of the front fork and try to move forward and backward.



Steering adjustment

1. To adjust, loosen stem bolt.
2. Use ring nut wrench to tighten ring nut.

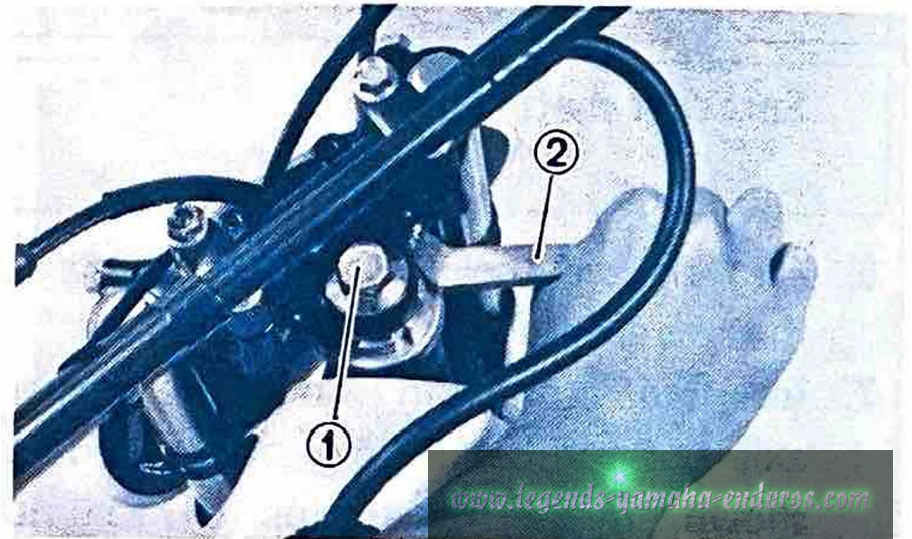

1. Stem bolt 2. Ring nut wrench

CAUTION:

Forks must swing from lock to lock without binding or catching.

3. Tighten stem bolt.

Tightening torque:

Stem bolt: 7.0 m-kp (50 ft-lb)

NOTE: _____
Steering head disassembly must be performed by your Yamaha dealer.

Front fork oil change

WARNING: _____

1. Fork oil leakage can cause loss of stability and safe handling. Have any problem corrected before operation the machine.
 2. Securely support the machine so there is no danger of it falling over.
-

1. Elevate front wheel by placing a suitable stand under the engine.
2. Loosen the pinch bolts and remove cap bolts from inner fork tubes.
3. Place container under each fork tube. Remove drain screw from each outer tube.

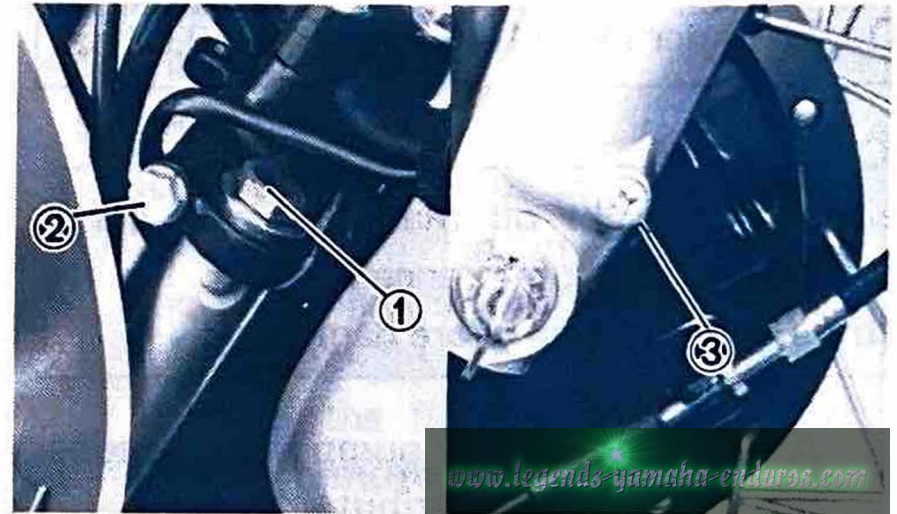

1. Cap bolt 2. Pinch bolt 3. Drain screw
4. After most of oil has drained, slowly raise and lower outer tubes to pump out remaining oil.
 5. Replace drain screw.

NOTE: _____
Check gasket, replace if damaged.

6. Measure correct amount of oil and pour into each leg.

Recommended oil:
Yamaha fork oil 10 wt or equivalent

Quantity per leg: 116 ± 2 cc (3.9 ± 0.07 oz)

NOTE: _____

Select the weight oil that suits local conditions and your preference (lighter for less damping; heavier for more damping).

7. After filling, slowly pump the fork tubes up and down to distribute the oil.

NOTE: _____

Adjust the oil levels in both right and left front forks so they are even.

8. Inspect O-ring on fork cap bolts and replace if damaged.
9. Tighten the fork cap bolts and pinch bolt.

Fork cap bolt torque: 2.0 m-kg (14.5 ft-lb)

Pinch bolt torque: 2.5 m-kg (18 ft-lb)

MINOR REPAIRS

CARBURETOR

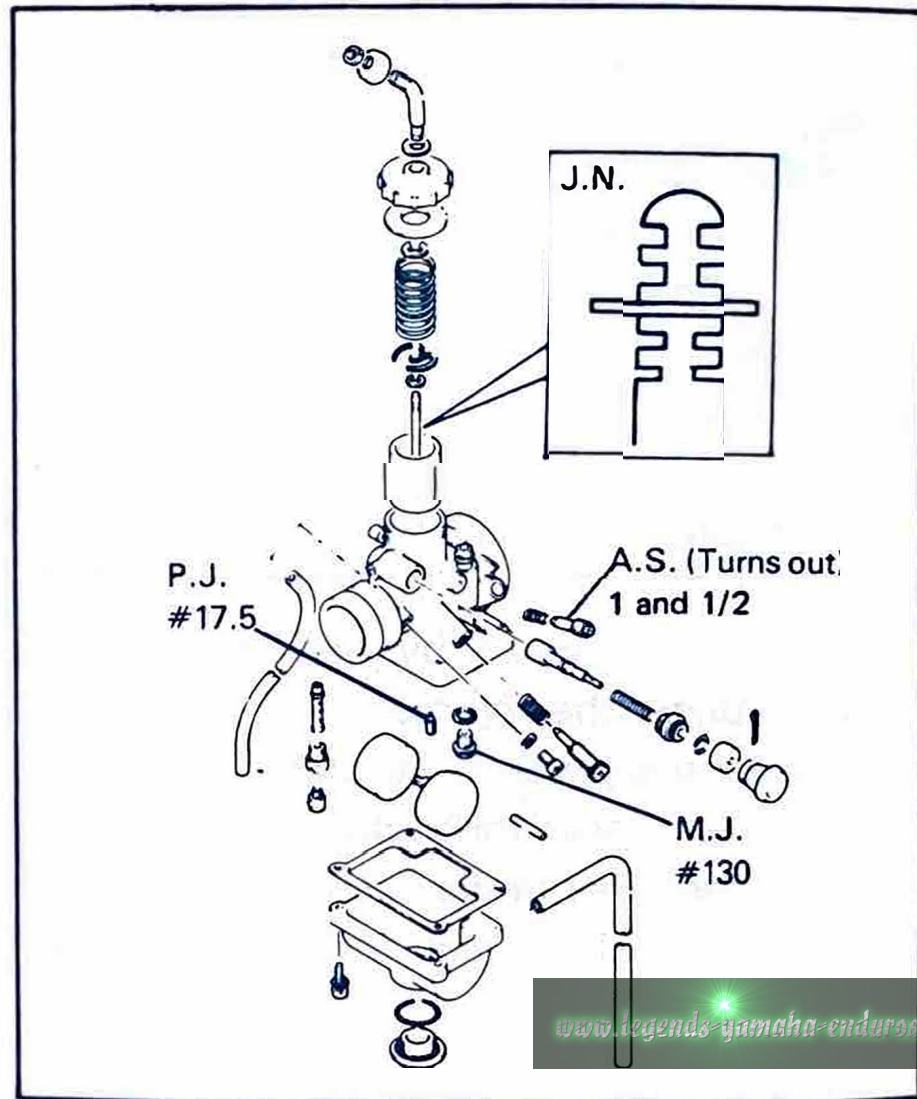

Inspection

1. Examine carburetor body and fuel passages. If contaminated, wash carburetor in petroleum based solvent. Do not use caustic carburetor cleaning solution. Blow out all passages and jets with compressed air.
2. Examine condition of floats. If floats are leaking or damaged, they should be replaced.
3. Inspect inlet needle valve and seat for wear or contamination. Replace these components as a set.

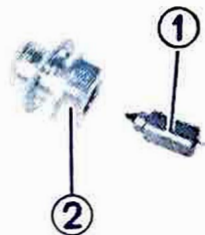

1. Needle

2. Valve seat

Adjustment

1. Float height
 - a. Checking

Hold the carburetor in an upside down position. While holding the float arm so the tang is just touching the float needle, measure the distance from the top of the float to the float bowl gasket surface (gasket removed). Both floats must be the same height.

Float height:

21.0 ± 1.5 mm (0.83 ± 0.06 in)

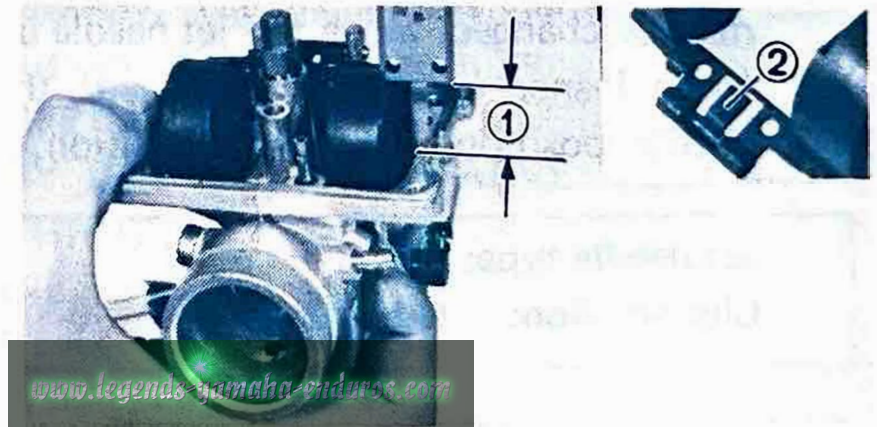

1. Float height

2. Tang

b. Adjustment

CAUTION:

Check the needle valve and valve seat for wear before adjustment.

Make the adjustment by bending the tang on the float arm.

2. Jet needle

The mid-range air/fuel supply is affected by the position of the needle in the needle jet. If it necessary to alter the mid-range air/fuel mixture characteristics of the machine, the jet needle position may be changed. Move the jet needle up for a leaner condition or toward the bottom position for a richer condition.

Jet needle type: 4L6-3

Clip position: No. 3 Groove

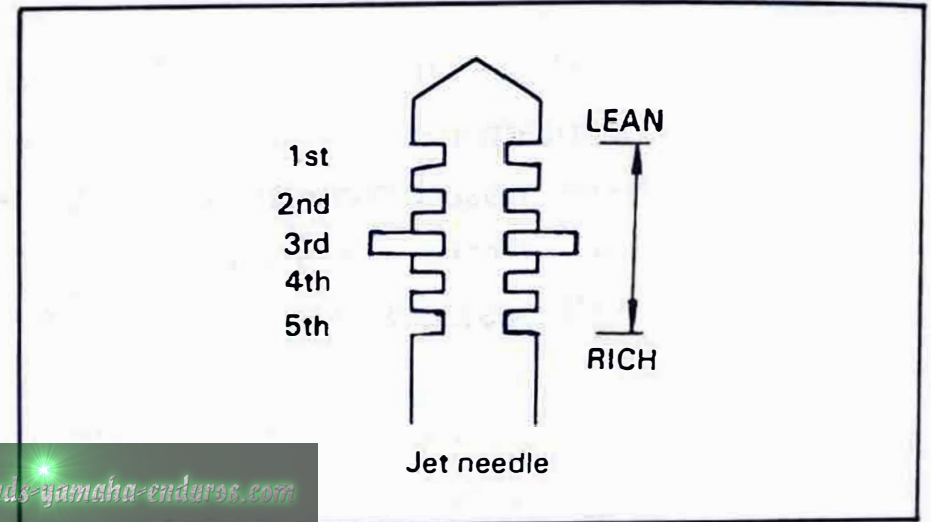

Troubleshooting

A motorcross machine requires immediate, predictable throttle response over a wide operating range. Cylinder porting, combustion chamber compression, ignition timing, muffler design, carburetor size and component selection are all balanced to achieve this goal. However, variations in temperature, humidity and altitude will affect carburetion and consequently, engine performance.

The following list gives each of the major components of the carburetor that can be

readily changed in order to modify performance if required. If you are unfamiliar with carburetor theory, we suggest you refrain from making changes. Quite often, a performance problem is caused by another related component, such as the exhaust system, ignition timing or combustion chamber compression.

NOTE: _____
See **MECHANICAL ADJUSTMENTS** for additional carburetor adjustments.

Pilot air screw:

Controls the ratio of air-to-fuel in the idle circuit. Turning the screw in decreases the air supply, giving a richer mixture.

OPERATING RANGE MOST AFFECTED BY THIS ADJUSTMENT: ZERO TO 1/8 THROTTLE.

Pilot jet:

Controls the ratio of fuel-to-air in the idle circuit. Changing the jet to one with a higher number supplies more fuel to the circuit giving a richer mixture.

OPERATING RANGE MOST AFFECTED BY THIS JET: ZERO TO 1/8 THROTTLE.

Throttle valve (slide):

The throttle valve (slide) has a portion of the base cutaway to control air flowing over the main nozzle. A wider angle (more "cutaway") will create a leaner mixture. Throttle valves are numbered according to the angle of the cutaway. The higher the number, the more cutaway, the leaner the mixture.

OPERATING RANGE MOST AFFECTED BY THE THROTTLE VALVE: 1/8 to 1/4 (+) THROTTLE.

Jet needle:

The jet needle is fitted within the throttle valve. The tapered end of the needle fits into the main nozzle outlet. Raising the needle allows more fuel to flow out of the needle. Moving the needle clip from the first, or top groove, through the fifth, or bottom groove, will give a correspondingly richer mixture.

OPERATING RANGEMOST AFFECTED BY THE JET NEEDLE: 1/4 to 3/4 (+) THROTTLE:

Main jet:

The main jet controls overall fuel flow through the main nozzle. Changing the jet to one with a higher number supplies more fuel to the main nozzle giving a richer mixture.

OPERATING RANGE MOST AFFECTED BY THE MAIN JET: 3/4 TO FULL THROTTLE:

NOTE:_____

Excessive changes in main jet size can affect performance at all throttle positions.

CAUTION:

The fuel/air mixture ratio is a governing factor upon engine operating temperature. Any carburetor changes, whatsoever, must be followed by a through spark plug test.

MINOR REPAIR FOR ENGINE

TOP END AND MUFFLER

With the carburetor removed, proceed as follows:

Muffler and cylinder head removal

1. Remove the nuts holding muffler to cylinder and remove the muffler mounting bolts.
2. Remove spark plug lead wire. Loosen, but do not remove spark plug.
3. Remove nuts securing cylinder and head (4 nuts).

Remove cylinder head and gasket.

NOTE:

Break each nut loose (1/4 turn) prior to removing.



CYLINDER HEAD AND CYLINDER

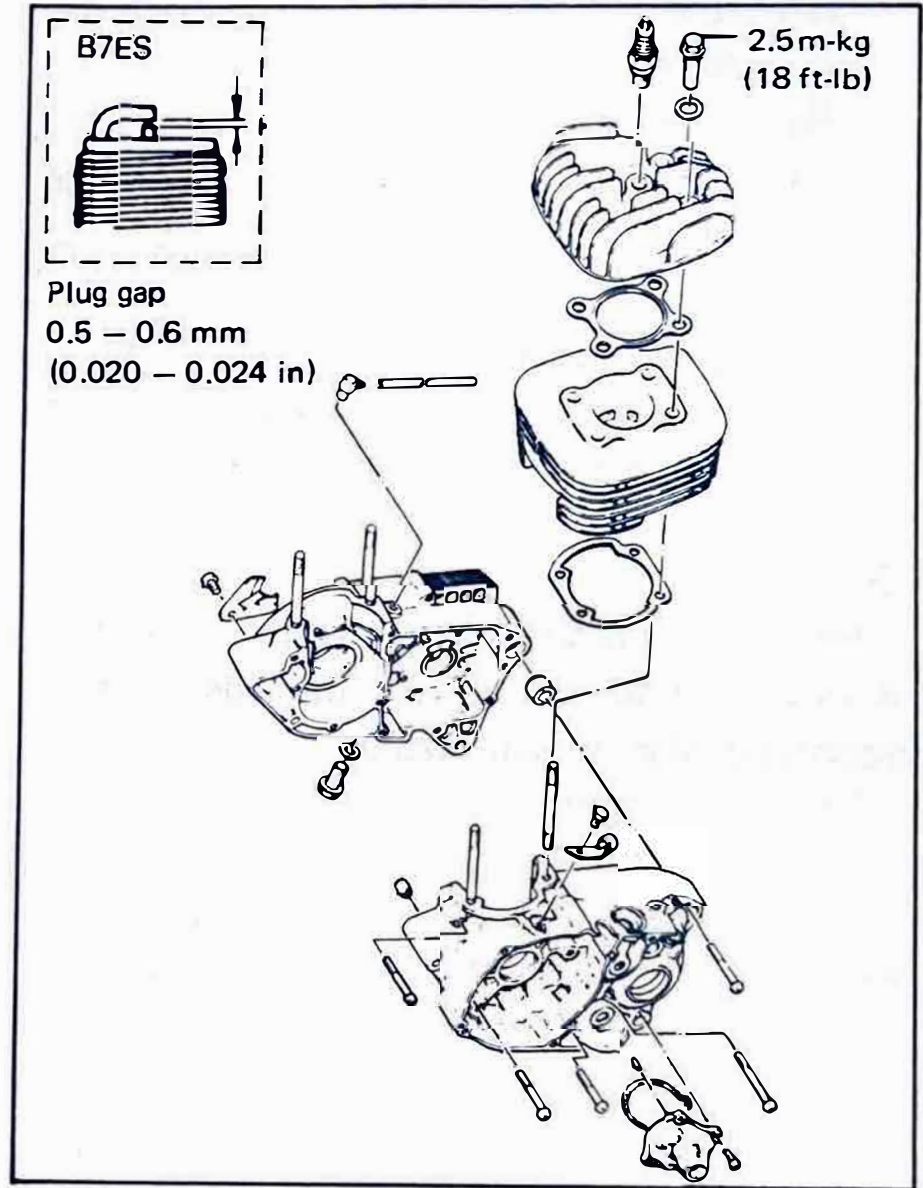

Cylinder removal

1. With the piston at top dead center, rise the cylinder until the cylinder skirts clear crankcase. Stuff a clean shop rag into crankcase cavity, around rod, to prevent dirt and other foreign particles from entering. Remove cylinder.
2. Remove the piston pin clip (1) from the piston. Push the piston pin out from opposite side. Remove the piston.

NOTE:

If the pin hangs up, use a piston pin puller. Do not hammer on pin as damage to rod, piston and bearing will result.



PISTON

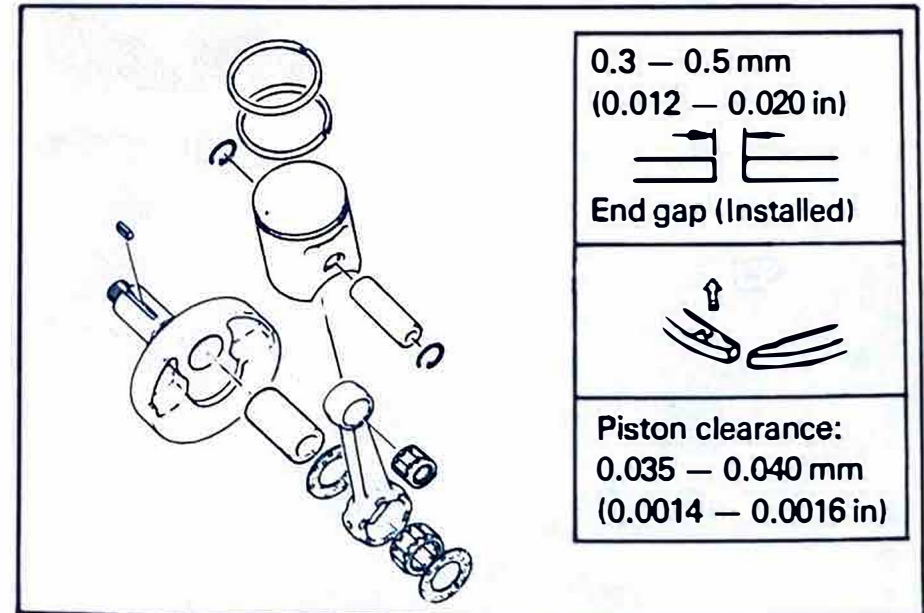

MAINTENANCE

Exhaust pipe

1. Using a rounded scraper, remove excess carbon deposits from manifold area of exhaust pipe. Check muffler gasket condition. The gasket seat is located around the cylinder exhaust port.
2. Carbon deposits within the silencer may be removed by lightly tapping the outer shell with a hammer and then blowing out with compressed air. Heavy wire, such as a coat hanger, may be inserted to break loose deposits. Use care.

Cylinder head

1. Remove spark plug.
2. Using a rounded scraper, remove carbon deposits from combustion chamber. Take care to avoid damaging the spark plug threads. Do not use a sharp instrument. Avoid scratching the metal surface.



3. Place the head on a surface plate. There should be no warpage. Correct by resurfacing. Place 400 ~ 600 grit wet emery sandpaper on surface plate and re-surface head using a figure-eight sanding pattern. Rotate head several times to avoid removing too much material from one side.
4. Clean the spark plug gasket mating surface thoroughly.

Cylinder

1. Remove reed valve assembly.
2. Using a rounded scraper, remove carbon deposits from exhaust port.



3. Remove cylinder base gasket and clean gasket seat on cylinder and crankcase thoroughly.
4. Check cylinder bore. Using a cylinder hone, remove any scoring. Hone lightly, using smooth stones. Hone no more than required to avoid excess piston clearance.

Piston

1. Using a rounded scraper, remove carbon deposits from piston crown.
2. Break a used piston ring two. File end square. De-burr edges to avoid scratching ring groove and clean carbon deposits from ring grooves.

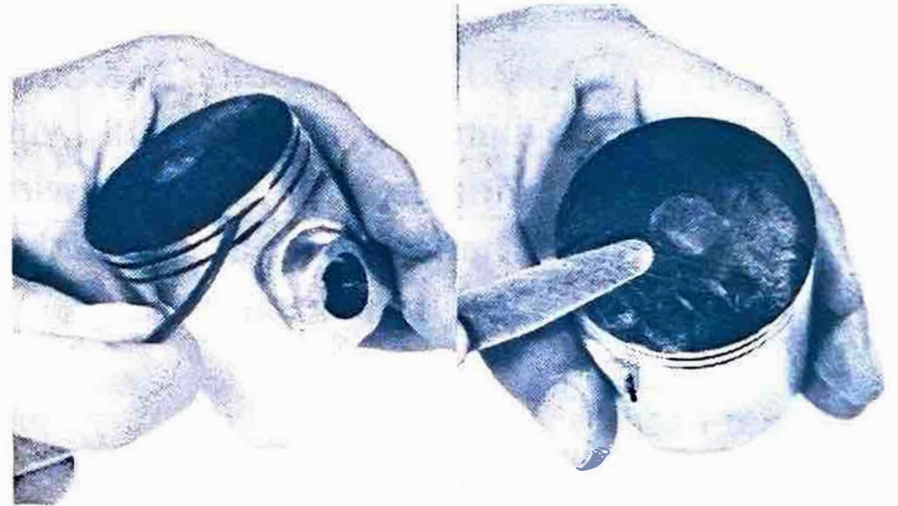

3. Using 400 ~ 600 grit wet sandpaper, lightly sand score marks and lacquer deposits from sides of piston. Sand in cross-hatch pattern. Do not sand excessively.



PISTON CLEARANCE

Cylinder bore measurement

Using a cylinder gauge set to standard bore size, measure the cylinder. Measure front-to-rear and side-to-side at top, center and bottom just above exhaust port. Compare minimum and maximum measurements. If over tolerance and not correctable by honing, rebore to next oversize.

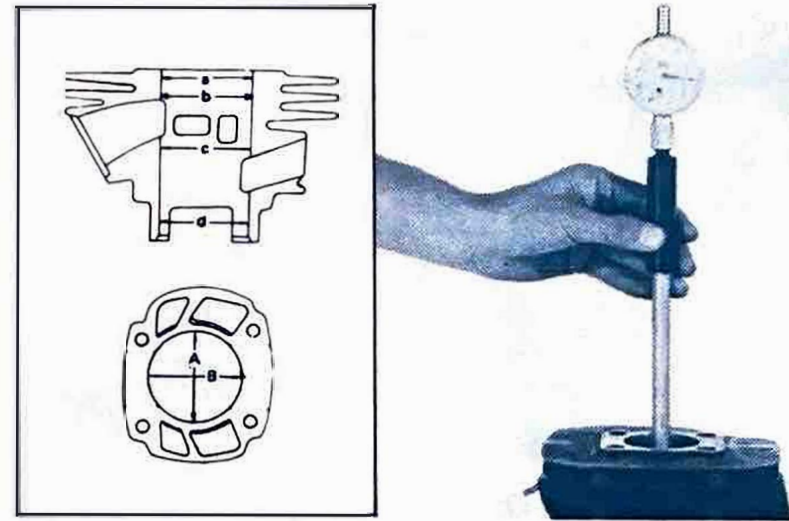

Piston outside diameter measurement

Using an outside micrometer, measure piston diameter. The measuring point is at right-angles to the piston pin holes, about 5 mm (0.2 in) from the bottom of the piston skirts.

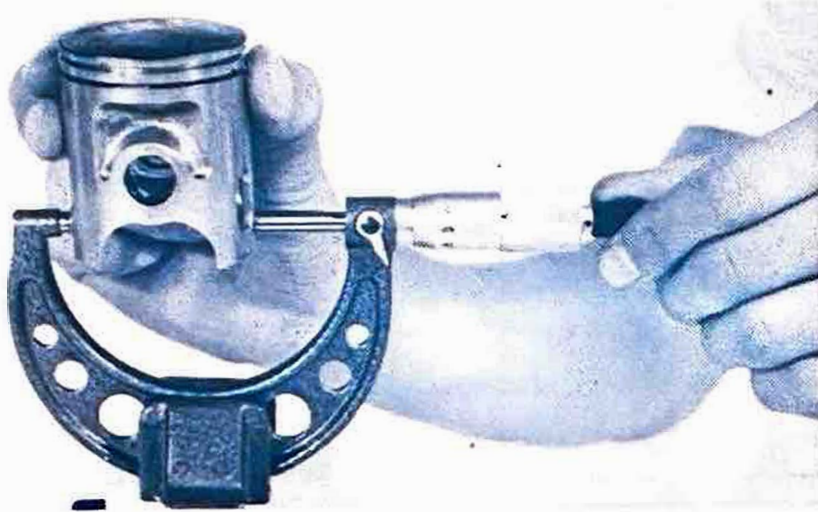

PISTON CLEARANCE

= Minimum Cylinder Diameter
– Maximum Piston Diameter

Example:

49.020 mm – 48.985 mm = 0.035 mm
(1.9299 in) – (1.9285 in) = (0.0014 in)

Nominal piston clearance:
0.035 mm ~ 0.040 mm
(0.014 in ~ 0.0016 in)

If beyond tolerance replace piston or rebore cylinder as required.

Piston rings

1. Remove ring from piston.
2. Insert ring into cylinder. Push down approximately 20 mm (0.79 in) using piston crown to maintain right-angle to bore. Measure installed end gap. If beyond tolerance, replace.

Ring end gap installed (top and 2nd):
0.3 ~ 0.5 mm (0.012 ~ 0.020 in)



3. Holding cylinder towards light, check for full seating of ring around bore. If not

fully seated, check cylinder. If cylinder is not out-of-round, replace piston ring.

4. During installation, make sure ring ends are properly fitted around ring locating pin in piston groove. Apply liberal coating of two-stroke oil to ring.

NOTE: _____
New rings require break-in. Follow first portion of new machine break-in procedure.

Piston pin, bearing and connecting rod

1. Check the pin for signs of wear. If any wear is evident, replace pin and bearing.
2. Check the pin and bearing for signs of heat discoloration. If excessive (heavily blued), replace both.
3. Check the bearing cage for excessive wear. Check the rollers for signs of flat spots. If found, replace pin and bearing.
4. Apply a light film of oil to pin and bearing surfaces. Install in connecting

rod small end. Check for play. There should be no noticeable vertical play. If play exists, check connecting rod small end diameter for wear. Replace pin and bearing or all as required.

5. Mount the dial gauge at right angles to connecting rod small end holding the bottom of rod toward the dial indicator, rock top of rod and measure axial play.

Connecting rod axial play:
0.8 ~ 2.0 mm (0.031 ~ 0.079 in)

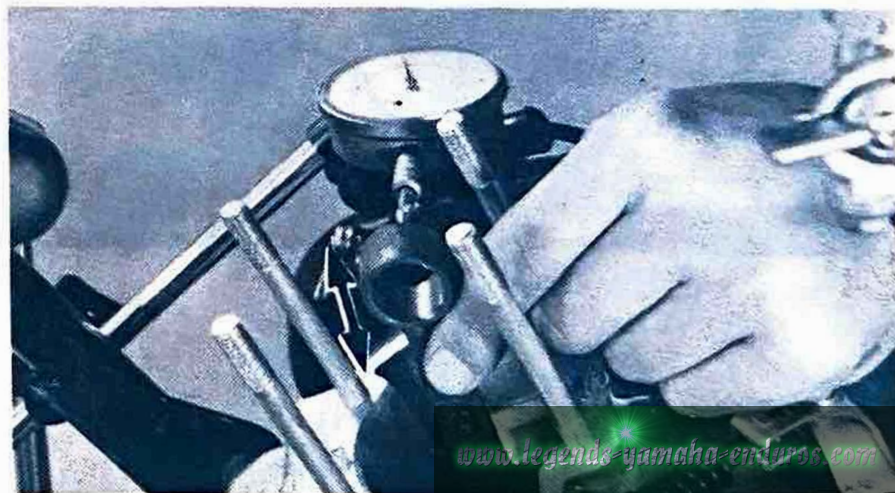

6. Remove the dial gauge and slide the connecting rod to one side. Insert a feeler gauge between the side of the crank wheel. Measure clearance.

Connecting rod/crank side clearance:
0.2 ~ 0.8 mm (0.008 ~ 0.031 in)

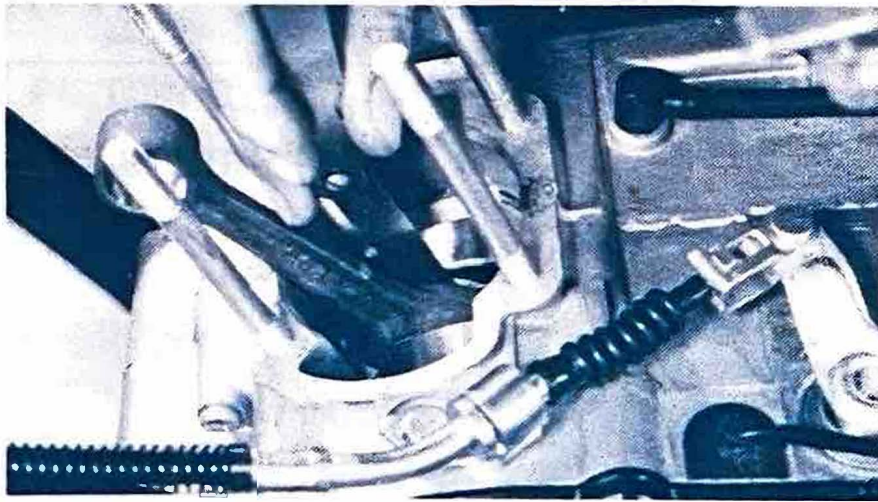

7. If any of the above measurements exceed tolerance, crankshaft repair is required. Take the machine to your authorized dealer.
8. During assembly apply a liberal coating of two-stroke oil to the piston pin and bearing. Apply several drops of oil to the connecting rod big end. Apply several drops of oil into each crankshaft bearing oil delivery hole.



REED VALVE

Removal

1. With carburetor, top end, and muffler removed, remove the four (4) bolts holding the intake manifold and reed valve assembly to the cylinder. Remove the assembly.

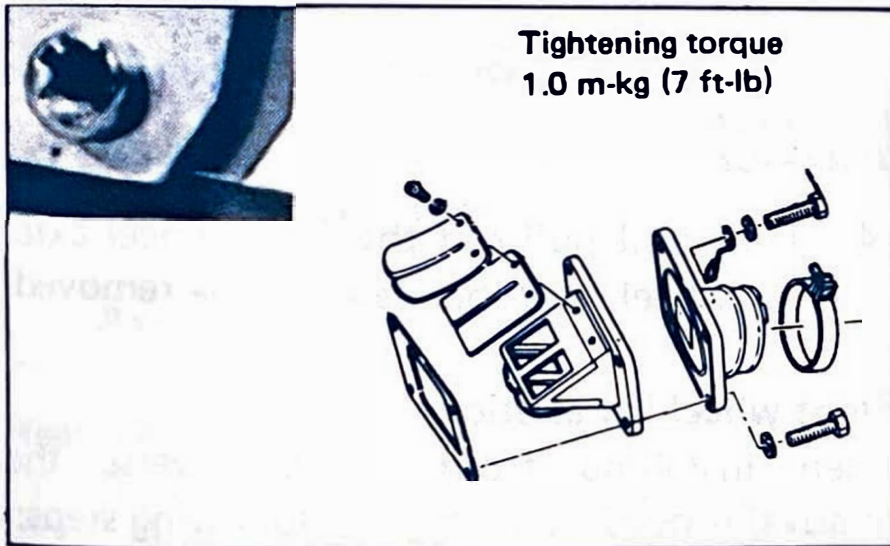

Inspection

1. Inspect rubber intake manifold for signs of weathering, cracking or other deterioration.

2. Inspect reed petals for signs of fatigue and cracks. Reed petals should fit flush or nearly flush against neoprene seats. If in doubt as to sealing ability, apply suction to carburetor side of assembly. Leakage should be slight to moderate.
3. The valve stopper controls the movement of the valve. Check clearance "a".

Standard value "a": 7 mm (0.28 in)

If it is 0.5 mm (0.02 in) more or less than specified, replace the valve stopper.



4. Check reed valve for bending. If beyond tolerance, replace reed valve.

Reed valve bending limit:
0.3 mm (0.012 in) or less

MINOR REPAIR FOR CHASSIS

Front wheel removal

1. Elevate the front wheel by placing a suitable stand under the engine.
2. Remove brake cable: Loosen all cable adjuster screws and remove cable from handle lever holder. Then remove cable from cam lever at front brake shoe plate.
3. Remove cotter pin from front wheel axle and remove axle nut.

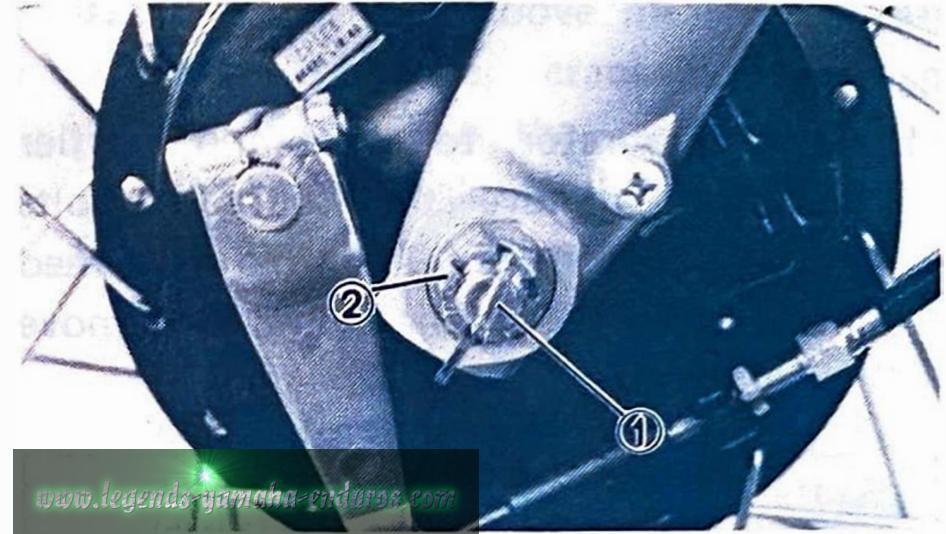

1. Cotter pin
2. Axle nut

4. Turn and pull out the front wheel axle; the wheel assembly can now be removed.

Front wheel installation

When installing front wheel, reverse the removal procedure taking the following steps:

1. Check for proper engagement of the boss on the outer fork tube with the locating slot on the brake shoe plate.



2. Always use a new cotter pin. Old pin should be discarded.

Axle nut torque: 4.5 m-kg (32 ft-lb)

Rear wheel removal

1. Remove the tension bar and the brake rod from the brake shoe plate. The tension bar can be removed by removing the cotter pin and nut from the tension bar bolt. The brake rod can be removed by removing the adjuster.

2. Loosen the lock nuts of the right and left chain pullers and loosen the adjuster bolts.
3. Remove the master link clip and master link and remove the chain from the rear sprocket.
4. Remove the cotter pin from the wheel axle and remove the rear wheel axle nut and sprocket shaft nut.

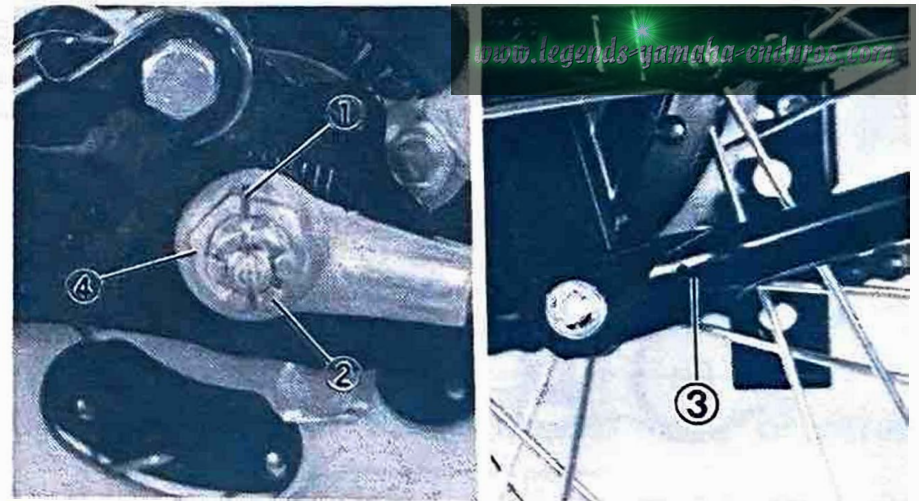

1. Cotter pin 2. Axle nut 3. Tension bar
4. Sprocket shaft nut

5. The rear wheel assembly, the collar, the chain puller(s), etc., can be removed

from the motorcycle by pulling the wheel axle.

Rear wheel installation

The rear wheel can be installed by reversing the removal procedure. Take the following steps.

1. When connecting the chain, make certain closed end of master link clip is facing direction of rotation.

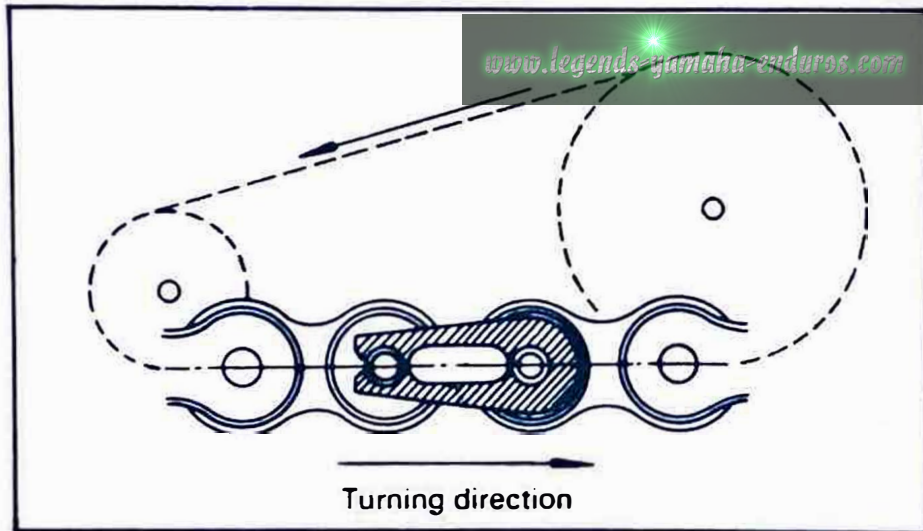

2. Be sure to adjust the tension of the chain. (Refer to "Drive chain tension adjustment".)

3. Always use a new cotter pin. Old pins should be discarded.

Tightening torque:

Sprocket shaft nut:

11.0 m-kg (80.0 ft-lb)

Axle nut: 4.0 m-kg (29.0 ft-lb)

Brake shoe inspection

Measure the outside diameter of the brake shoe set with slide calipers.

If they measure less than replacement limit, replace them. Smooth out any rough spots on shoe surface with sandpaper.

	Front	Rear
Brake shoe diameter	110 mm (4.33 in)	110 mm (4.33 in)
Replacement limit	106 mm (4.17 in)	106 mm (4.17 in)

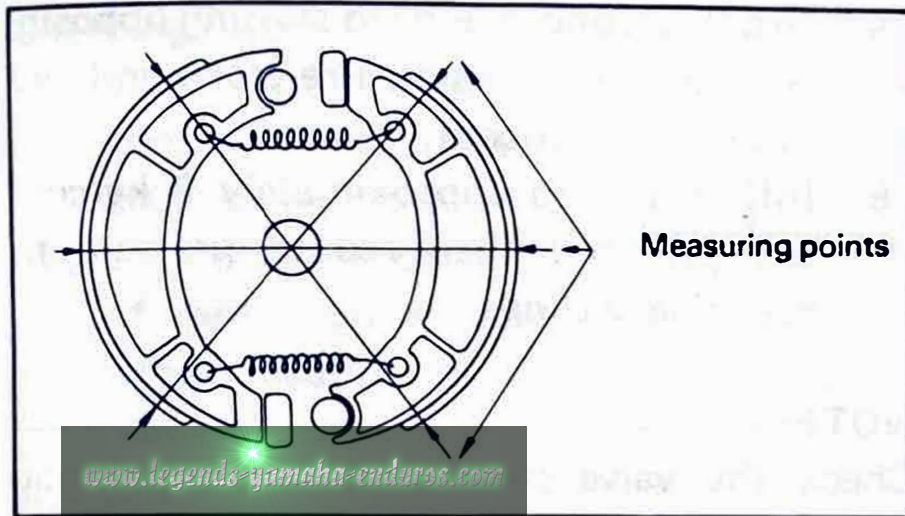

Brake drum inspection

Check the inner surface of the brake drum and remove any scratches with emery cloth. Remove any oil with a cloth dipped in solvent. If damage is more extensive, have a Yamaha dealer replace the wheel hub.

Tire removal and tire repair

1. Remove the wheel from the machine.
2. Remove lock nut from valve stem and release as much air as possible from the tire.

3. Push both tire beads away from the edges of the rim.
4. Starting opposite the valve stem on one side, use two round-ended tire irons to work the bead off the rim.

NOTE: _____

Use a tire removal lubricant and be careful not to pinch the tube with the tire irons.

5. Remove the valve stem from its hole and remove the tube.
6. If the tire is to be changed, remove the second bead from the rim using the tire irons and tire lubricant.

Inspection

1. Use a cloth to check for nails or other sharp objects in the tire.

CAUTION: _____

Always use a cloth to avoid cutting your hand.

2. Check for faults in the side wall. If there is any fault, the tire should be replaced as a damaged tire may burst at high speeds, which is extremely dangerous.
3. Inflate the tube with air and check the valve stem and the tube for damage and leakage replace as required. Some leaks can be patched in an emergency, but it is best to replace tube.

Reassembly

1. Install one tire bead on the rim using tire irons and lubricant and then install the tube.
2. Inflate tube with air to about one-third the specified pressure. Hit the outer circumference of the tire with a soft hammer to make certain the tube is not caught between tire and rim. Release air from tube.
3. Inspect rim band and replace if damaged.

4. Install second tire bead starting opposite the valve stem using tire irons and tire mounting lubricant.
5. Inflate tire to approximately 3 kg/cm² (42 psi) and then reduce pressure to specified setting.

NOTE: _____
Check the valve stem; it must be pointing directly at center of wheel hub. If angled in any direction, release air and adjust tube position.

www.legends-yamaha-enduros.com

Tire air pressure

Improper tire pressure affects the smoothness of the tire, traction, handling and the life of the tires. Always maintain the correct tire pressure.

Check the spokes

If they are loose or bent, tighten or replace them. The spokes should be checked before each use.

Checking rim

1. Check for cracks, bends or warpage of rim. If a rim is deformed or cracked, it must be replaced.
2. Check wheel run-out

If deflection exceeds tolerance, check wheel bearing or replace wheel as required.

Rim run-out limits:

Vertical – 2.0 mm (0.08 in)

Lateral – 2.0 mm (0.08 in)

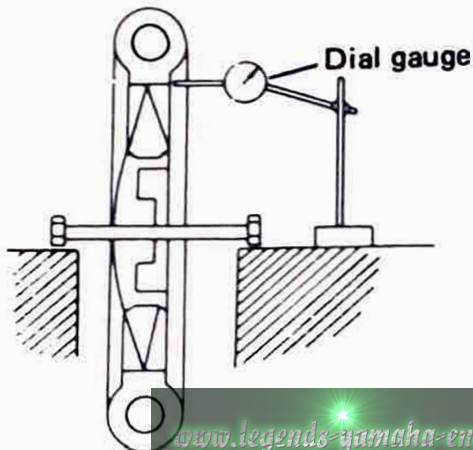

Replacing wheel bearings

If the bearings allow excessive play in the wheel or if it does not turn smoothly have your dealer replace the wheel bearings.

Swing arm inspection

1. With shock absorber removed, grasp the ends of the arm and move from right to left to check for free play.

Swing arm free play: None

Cable inspection and lubrication

WARNING:

Damage to the outer housing of the various cables may cause corrosion and often free movement will be obstructed. An unsafe condition may result so replace such cables as soon as possible.

1. Lubricate the inner cable and cable end. If they do not operate smoothly, ask your Yamaha dealer to replace them.

Recommended lubricant:

Yamaha chain and cable lube or
SAE 10W/30 motor oil

www.legends-yamaha-enduros.com

Throttle cable and grip lubrication

The throttle twist grip assembly should be greased at the time that the cable is lubricated, since the grip must be removed to get at the end of the throttle cable. Two screws clamp the throttle housing to the handlebar. Once these two are removed, the end of the cable can be held high to pour in several drops of lubricant. With the throttle grip disassembled, coat the metal surface of the grip assembly with a suitable all-purpose grease to cut down friction. (See lubrication chart.)

Lubrication of levers, pedals, etc.

1. Lubricate the pivoting parts of the brake and clutch levers with Yamaha chain and cable lube or SAE 10W/30 motor oil.
2. Lubricate the shaft of the brake pedal with lithium base grease.

CABLE ROUTING

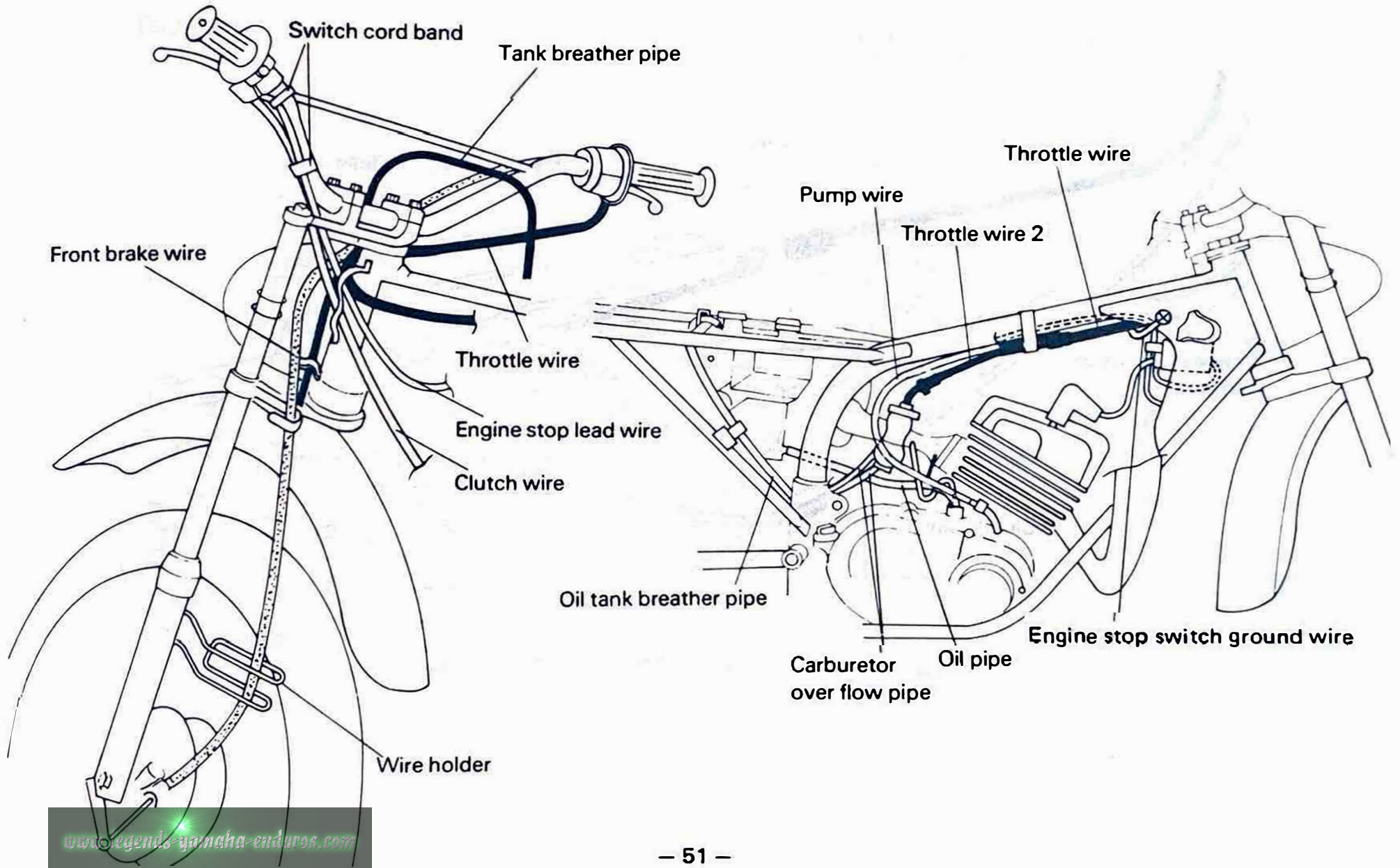

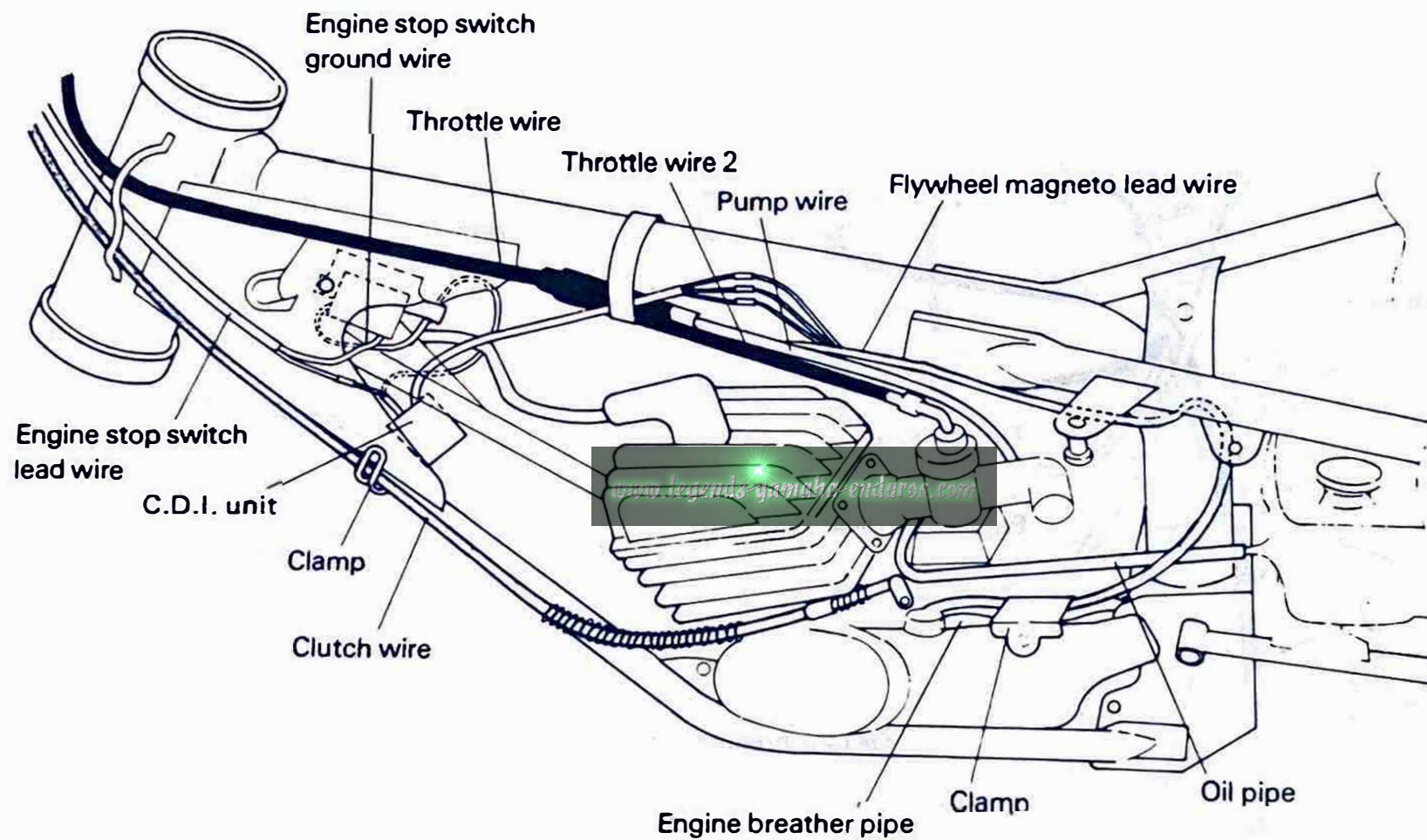

IGNITION

Wiring Diagram:

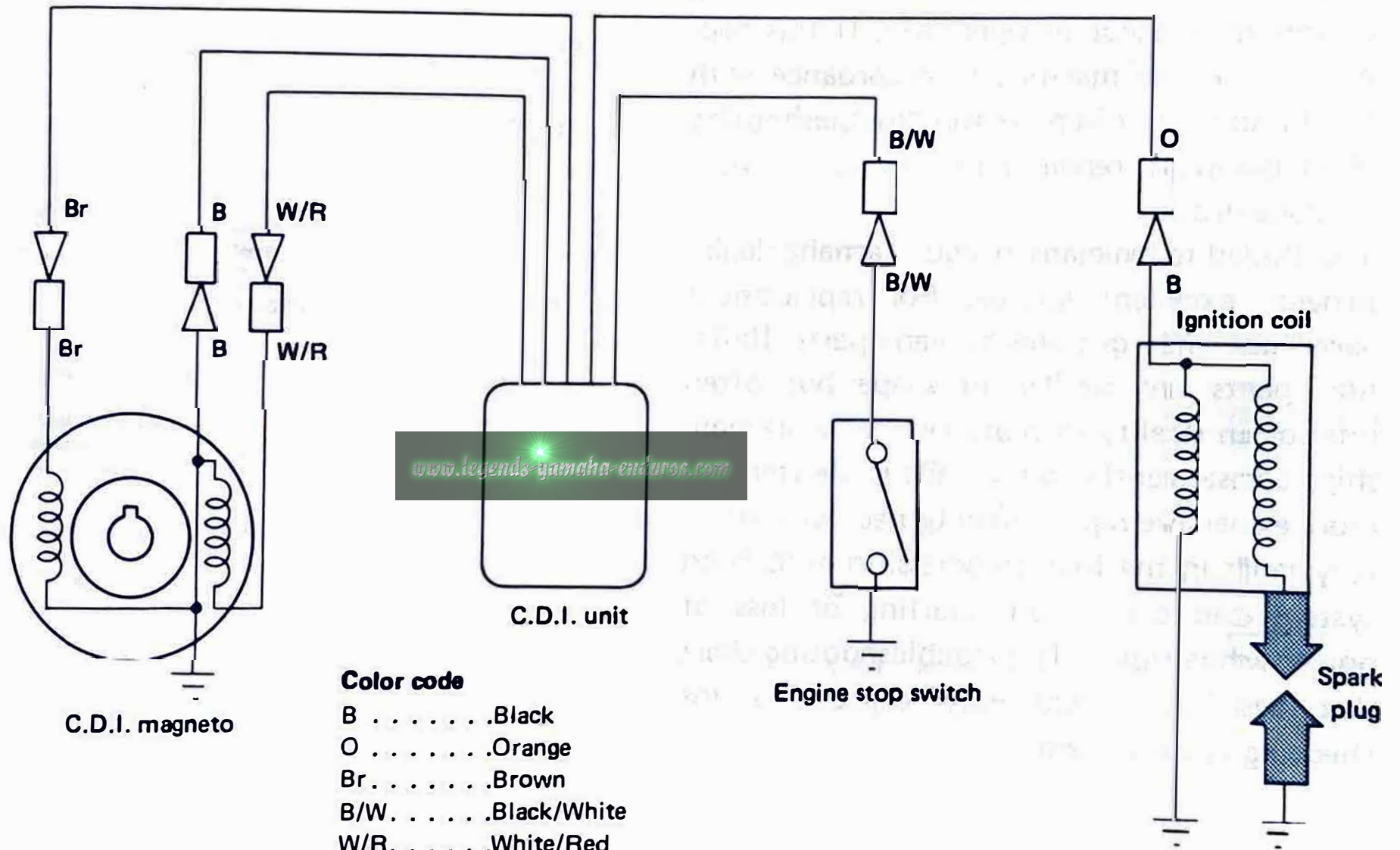

Troubleshooting

Although Yamaha machines are given a rigid inspection before shipment from the factory, trouble may occur in operation. If this happens check the machine in accordance with the procedures given in the troubleshooting chart below. If repair is necessary, ask your Yamaha dealer.

The skilled technicians at your Yamaha dealer provide excellent service. For replacement parts, use only genuine Yamaha parts. Imitation parts are similar in shape but often inferior in quality of materials and workmanship; consequently, service life is shorter and more expensive repairs may be necessitated.

Any fault in the fuel, compression or ignition system can cause poor starting or loss of power while riding. The troubleshooting chart describes quick and easy procedures for checking these systems.

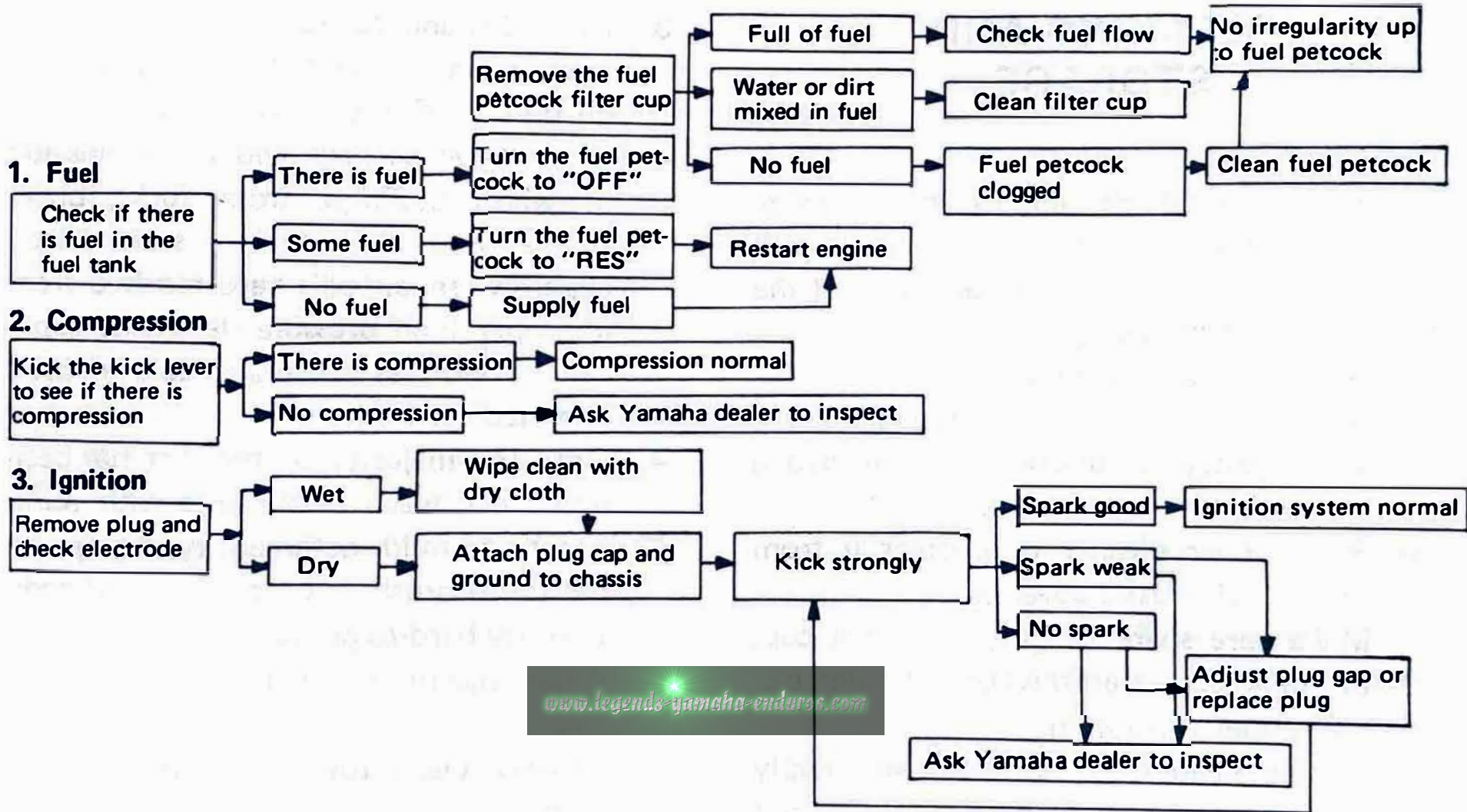

CLEANING AND STORAGE

A. CLEANING

Frequent thorough cleaning of your machine will not only enhance its appearance but will improve general performance and extend the useful life of many components.

1. Before cleaning the machine:
 - a. Block off end of exhaust pipe to prevent water entry; a plastic bag and strong rubber band may be used.
 - b. Remove air cleaner or protect it from water with plastic covering.
 - c. Make sure spark plug(s), fuel tank cap, oil tank cap, transmission oil filler cap are properly installed.
2. If engine case is excessively greasy, apply degreaser with a paint brush. Do not apply degreaser to chain, sprockets, or wheel axles.
3. Rinse dirt and degreaser off with garden hose, using only enough hose pressure to do the job. Excessive hose pressure may cause water seepage and contamination of wheel bearings, front forks, brake drums, and transmission seals. Many expensive repair bills have resulted from improper high pressure detergent applications such as those available in coin-operated car washers.
4. Once the majority of the dirt has been hosed off, wash all surfaces with warm water and mild, detergent-type soap. An old tooth brush or bottle brush is handy to reach hard-to-get-to places.
5. Rinse machine off immediately with clean water and dry all surfaces with a chamois, clean towel, or soft absorbent cloth.
6. Immediately after washing, remove excess moisture from chain and lubricate to prevent rust.

7. Chrome-plated parts such as handlebars, rims, spokes, forks, etc., may be further cleaned with automotive chrome cleaner.
8. Clean the seat with a vinyl upholstery cleaner to keep the cover pliable and glossy.
9. Automotive-type wax may be applied to all painted and chrome-plated surfaces. Avoid combination cleaner-waxes. Many contain abrasives which may mar paint or protective finish on fuel and oil tanks.
10. After finishing, start the engine immediately and allow to idle for several minutes.

B. STORAGE

Long term storage (60 days or more) of your machine will require some preventive procedures to insure against deterioration. After cleaning machine thoroughly, prepare for storage as follows:

1. Drain fuel tank, fuel lines, and carburetor float bowl(s).
2. Remove empty fuel tank, pour a cup of SAE 10W/30 oil in tank, shake tank to coat inner surfaces thoroughly and drain off excess oil. Re-install tank.
3. Remove spark plug(s), pour about one tablespoon of SAE 10W/30 oil in spark plug hole(s) and re-install spark plug. Kick engine over several times (with ignition off) to coat cylinder walls with oil.
4. Remove drive chain. Clean thoroughly with solvent and lubricate. Re-install chain or store in a plastic bag (tie to frame for safe-keeping).

5. Lubricate all control cables.
6. Block up frame to raise both wheels off ground.
7. Tie a plastic bag over exhaust pipe outlet(s) to prevent moisture from entering.
8. If storing in humid or salt-air atmosphere, coat all exposed metal surfaces with a light film of oil. Do not apply oil to rubber parts or seat cover.

NOTE: _____
Make any necessary repairs before storing the machine.

SPECIFICATIONS

A. General

Model: Model (I.B.M No.) Frame I.D. & Starting Number Engine I.D. & Starting Number	3T0 3T0-060101 3T0-060101
Dimension: Overall Length Overall Width (standard) Overall Height (standard) Seat Height Wheelbase Minimum Ground Clearance	1,795 mm (70.7 in) 800 mm (31.5 in) 960 mm (37.8 in) 730 mm (28.7 in) 1,190 mm (46.9 in) 200 mm (7.9 in)
Weight: Net Weight	77 kg (170 lb.)
Performance: Minimum Turning Radius	1,810 mm (71.3 in)

B. Engine

<p>Description:</p> <p>Engine Type Engine Model Displacement Bore x Stroke Compression Ratio Starting System Ignition System Lubrication System</p>	<p>Air cooled, 2-stroke gasoline, Torque induction 3T0 97 cc (5.92 cu.in) 52 x 45.6 mm (2.047 x 1.795 in) 6.7 : 1 Primary kick starter C.D.I. Separate lubrication (Yamaha Autolube)</p>
<p>Cylinder Head:</p> <p>Combustion Chamber Volume Combustion Chamber Type Head Gasket Thickness</p>	<p>12.4 cc (0.76 cu.in) Squish 0.7 mm (0.028 in)</p>
<p>Cylinder:</p> <p>Material Bore Size Taper Limit Out of Round Limit</p>	<p>Cast iron 52 mm (2.05 in) 0.05 mm (0.002 in) 0.01 mm (0.0004 in)</p>
<p>Piston:</p> <p>Piston Skirt Clearance Piston Over Size Piston Pin Outside Diameter x Length</p>	<p>0.035 ~ 0.040 mm (0.0014 ~ 0.0016 in) 52.25, 52.50, 52.75, 53.00 mm (2.06, 2.07, 2.08, 2.09 in) 14 x 41 mm (0.55 x 1.61 in)</p>

Piston Ring: Piston Ring Design (Top) Piston Ring Design (2nd) Ring End Gap (Installed) (Top) Ring End Gap (Installed) (2nd) Ring Groove Side Clearance (Top) Ring Groove Side Clearance (2nd)	Keystone Plane (with expander) 0.3 ~ 0.5 mm (0.012 ~ 0.020 in) 0.3 ~ 0.5 mm (0.012 ~ 0.020 in) 0.03 ~ 0.05 mm (0.001 ~ 0.0020 in) 0.03 ~ 0.07 mm (0.001 ~ 0.0027 in)
Small End Bearing: Type	Needle bearing
Big End Bearing: Type	Needle bearing
Crankshaft: Crankshaft Assembly Width (F) Crankshaft Deflection (A) Connecting Rod Big End Side Clearance (C) Connecting Rod Small End Deflection (S) Crank Pin Outside Diameter x Length Crank Pin Type Crank Bearing Type (Left) x Q'ty Crank Bearing Type (Right) x Q'ty Crank Oil Seal Type (Left) x Q'ty Crank Oil Seal Type (Right) x Q'ty	50 $\begin{matrix} -0.05 \\ -0.10 \end{matrix}$ mm (1.97 $\begin{matrix} -0.002 \\ -0.004 \end{matrix}$ in) 0.03 mm (0.001 in) 0.2 ~ 0.8 mm (0.008 ~ 0.031 in) 0.8 ~ 2.0 mm (0.031 ~ 0.079 in) 22 x 48.7 mm (0.87 ~ 1.92 in) Hollow type 6304 x 1 6304 x 1 SD-20-40-8 SW-28-40-8

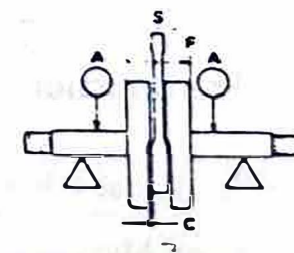

<p>Clutch:</p> <p>Clutch Type</p> <p>Clutch Operating Mechanism</p> <p>Primary Reduction Ratio & Method</p> <p>Friction Plate—Thickness/Quantity</p> <p>Friction Plate—Wear Limit</p> <p>Clutch Plate—Thickness/Quantity</p> <p>Clutch Plate—Warp Limit</p> <p>Clutch Spring—Free Length/Quantity</p> <p>Clutch Spring—Warp Limit</p> <p>Clutch Housing Axial Play (Wear Limit)</p> <p>Push Rod Bending Limit</p>	<p>Wet, multiple disc type</p> <p>Inner push type, Cam axle</p> <p>74/19 (3.895), Helical gear</p> <p>3.0 mm (0.12 in) x 5 pcs.</p> <p>2.7 mm (0.11 in)</p> <p>1.2 mm (0.047 in) x 4 pcs.</p> <p>0.05 mm (0.002 in)</p> <p>31.5 mm (1.24 in) x 5 pcs.</p> <p>0.05 mm (0.002 in)</p> <p>0.15 ~ 0.45 mm (0.006 ~ 0.018 in)</p> <p>0.15 mm (0.006 in)</p>
<p>Transmission:</p> <p>Type</p> <p>Gear Ratio 1st (Teeth) (Ratio)</p> <p>2nd</p> <p>3rd</p> <p>4th</p> <p>5th</p> <p>Transmission Gear Oil Quantity & Type</p> <p>Secondary Reduction Ratio & Method</p>	<p>www.legends-yamaha-enduros.com</p> <p>Constant mesh, 5-speed forward</p> <p>35/11 (3.181)</p> <p>30/15 (2.000)</p> <p>26/19 (1.368)</p> <p>23/23 (1.000)</p> <p>20/25 (0.800)</p> <p>650 ± 50 cc (0.7 ± 0.05 US.qt)</p> <p>(Yamalube 4-cycle or SAE 10W/30 "SE" motor oil)</p> <p>48/14 (3.429) Chain</p>
<p>Shifting Mechanism:</p> <p>Type</p>	<p>Guide bar, return type</p>

Kick Starter: Type	Kick-and-mesh
Intake: Air Cleaner—Type/Quantity —Oil Grade Induction System Reed Valve Type Bending Limit Valve Lift	Wet-foam rubber Yamalube 2-cycle oil Reed valve V type 0.3 mm (0.012 in) 7 mm (0.28 in)
Carburetor: Type/Manufacturer/Quantity I.D. Mark Main Jet (M.J.) Air Jet (A.J.) Jet Needle-clip Position (J.N.) Needle Jet (N.J.) Cutaway (C.A.) Pilot Jet (P.J.) Air Screw (turns out) (A.S.) Starter Jet (G.S.) Float height Engine Idling Speed	VM22SS/Mikuni/1 3M100 #130 2.5 4L6-3 0 - 6 2.0 #17.5 1-1/2 30 21.0 ± 1.5 mm (0.83 ± 0.06 in) 1,300 ~ 1,450 r/min

Lubrication: Autolube Pump—Color Code Autolube Pump—Minimum Stroke Autolube Pump—Maximum Stroke Autolube Pump—Reduction Ratio Autolube Pump—Minimum Output/200 strokes Autolube Pump—Maximum Output/200 strokes Throttle Position (Adjusting Mark) Oil Tank Capacity Oil Grade	Green 0.20 ~ 0.25 mm (0.008 ~ 0.010 in) 1.85 ~ 2.05 mm (0.073 ~ 0.081 in) 1/40 0.25 ~ 0.31 cc 2.32 ~ 2.57 cc ▲ 1.0 lit (1.1 US.qt) Yamalube 2-cycle oil or Air cooled 2-cycle engine oil
--	--

C. Chassis

Frame: Frame Design	Tubler, double cradle
Steering System: Caster Trail Number & Size of Balls in Steering Head Upper Race Lower Race Lock to Lock Angle	29° 103 mm (4.06 in) 3/16 in x 22 1/4 in x 19 47°

Front Suspension:	47°
Type Damper Type Front Fork Cushion Travel Front Fork Spring Free Length Wire Diameter x Winding Diameter Spring Constant Inner Tube Outside Diameter Oil Seal Type Front Fork Oil Quantity & Type	Telescopic fork Coil spring, oil damper 110 mm (4.33 in) 418.5 mm (16.48 in) 3 mm x 17.5 mm (0.12 x 0.69 in) 0.42 kg/mm, 0.57 kg/mm (23.5 lb/in), (31.9 lb/in) (0 ~ 70 mm) (70 ~ 110 mm) (0 ~ 2.8 in) (2.8 ~ 4.3 in) 27 mm PJ27-39-10.5 116 ± 2 cc (3.9 ± 0.07 oz), Yamaha fork oil 10 wt or equivalent
Rear Suspension: Type Damper Type Rear Shock Absorber Travel Rear Wheel Travel Swing Arm Free Play Pivot Shaft—Outside diameter Pivot Shaft—Type	Swing Arm Coil spring, Oil damper 75 mm (2.95 in) 84 mm (3.31 in) None 12 mm (0.47 in) Rubber bush
Fuel Tank: Capacity	4.5 lit (1.2 US.gal)

www.legends-yamaha-enduros.com

Fuel Grade	Regular gasoline
Wheel: Tire Size (Front) (Rear)	2.50-18-4PR 3.00-16-4PR
Tire Pressure (Front) (Rear) Rim Size (Front) (Rear) Rim Run out Limit (Front/Rear) Vertical Lateral Secondary Drive Chain Type Type Number of Links Chain Free Play	1.0 kg/cm ² (14 psi) 1.2 kg/cm ² (18 psi) 1.40 x 18 1.60 x 16 2 mm (0.08 in) 2 mm (0.08 in) RS420 103 link + Joint 20 ~ 30 mm (0.8 ~ 1.2 in)
Brake: Front Brake Type Drum Diameter (Limit) Shoe Diameter x Width Shoe Spring Free Length Lining Thickness (Wear Limit)	Leading, Trailing 110 mm 110 x 25 mm (4.33 x 0.98 in) 34.5 mm (1.36 in) 2 mm (0.08 in)

Rear Brake	
Type	Leading, Trailing
Drum Diameter	110 mm (4.33 in)
Shoe Diameter x Wider	109.8 x 25 mm (4.32 x 0.98 in)
Shoe Spring Free Length	34.5 mm (1.36 in)
Lining Thickness (Wear Limit)	2 mm (0.08 in)

D. Electrical

Ignition System:	
Type	C.D.I. magneto
Model/Manufacturer	F003T10461/Mitsubishi
Voltage	6V
Charge Coil Resistance	300Ω ± 10% (Brown)
Pulser Coil Resistance	10Ω ± 10% (White/Red)
Flywheel Puller Thread Size	27 mm (1.08 in)
Ignition Timing:	21° B.T.D.C. at 2,000 r/min [1.8 ± 0.15 mm (0.071 ± 0.006 in)]
Ignition Coil:	
Model/Manufacturer	F006T41674/Mitsubishi
Spark Gap	10 mm (0.39 in)
Primary Winding Resistance	1.0Ω ± 15% at 20°C
Secondary Winding Resistance	5.9kΩ ± 15% at 20°C

Spark Plug Type/Manufacture	B7ES/NGK
Spark Plug Gap	0.5 ~ 0.6 mm (0.020 ~ 0.024 in)
CDI Unit Type/Manufacture	F008T02473/Mitsubishi

www.legends-jancho-enduro.com

Front axle nut	4.5 m-kG (32 ft-lb)
Rear axle nut	4.0 m-kG (29 ft-lb)
Sprocket shaft nut	15 m-kG (108 ft-lb)
Drive sprocket bolt	2.0 m-kG (14 ft-lb)
Footrest bolt	2.0 m-kG (14 ft-lb)
Tensionbar (Brake plate)	2.0 m-kG (14 ft-lb)
(Rear arm)	2.0 m-kG (14 ft-lb)

www.legends-yamaha-enduros.com

WARRANTY INFORMATION

Please refer to your copy of the Yamaha Owner's Warranty Guide* for details of the warranty offered on your new Yamaha.

The Warranty Guide contains the warranty policy, an explanation of the warranty, and other important information. Becoming familiar with these policies will be to your advantage in making the best use of Yamaha's warranty programs.

There are certain requirements which you must meet in order to qualify for warranty coverage.

FIRST, your new Yamaha must be operated and maintained properly, as explained in this manual. If you have any questions about any procedure in this manual, please consult your dealer. **ABUSE AND NEGLECTED MAINTENANCE MAY LEAD TO MECHANICAL FAILURES WHICH CANNOT BE COVERED UNDER WARRANTY.**

SECOND, IF ANY PROBLEMS OCCUR WHICH YOU FEEL SHOULD BE COVERED UNDER WARRANTY, NOTIFY YOUR DEALER IMMEDIATELY. Don't delay, as small problems left unrepaired can become large problems which may not be covered under warranty.

We recommended that the Warranty Guide be used as a folder in which you may keep your registration and other important documents related to your new Yamaha.

* The Yamaha Owner's Warranty Guide is to be supplied by your Yamaha dealer at the time of purchase. If you did not receive one, or have lost yours, you may obtain extra copies upon request from your Yamaha dealer or by writing to:

YAMAHA MOTOR CORPORATION, USA
6555 Katella Ave.
P.O. Box 6555
Cypress, California 90630
Attn: Warranty Department

— MEMO —

.....

.....

.....

.....

.....

.....

.....

.....

.....

.....

.....

— MEMO —

.....

.....

.....

.....

.....

.....

.....

.....

.....

.....

.....

— MEMO —

.....

.....

.....

.....

.....

.....

.....

.....

.....

.....

.....

www.legends-yamaha-enduros.com



YAMAHA MOTOR CO.,LTD.

IWATA JAPAN

PRINTED IN JAPAN

81 · 4 · 1.6 x 1 CR

(英)