

YAMAHA ENDURO

175CT2

www.legends-yamaha-enduros.com

314-28199-10

Congratulations! You are now the owner of a new Yamaha 175 ENDURO CT2. The CT2 is a high-performance motorcycle manufactured by the leading manufacturer of motorcycles in Japan.

The CT2 is designed for competition and road use. It features a rugged, powerful, 2-stroke single cylinder engine, and Autolube, the revolutionary lubricating system developed by Yamaha Technical Research Laboratory and prove in all Yamaha models.

This manual explains some steps necessary for operating and caring for your new motorcycle. Please read it carefully to become thoroughly familiar with all the features and advantages built into your CT2.

www.legends-yamaha-enduros.com

CONTENTS

Information.....	1
Contents.....	2
I. Features and Specifications.....	3
I. Features.....	3
II. Yamaha Autolube.....	5
III. Nomenclature.....	6
IV. Basic Instructions.....	9
I. Gasoline and Oil.....	9
2. Familiarization of Equipment.....	10
3. Pre-operation Check.....	13
4. Operation.....	14
5. Break-in Procedure.....	18
V. Service Tools.....	20
VI. Inspection and Service.....	21
I. Inspection and Adjustment.....	23

www.legends-yamaha-enduros.com

I. Features and Specifications

1. Features

(1) Reed Valve employed in Inlet System

Another new type engine has made its debut! The reed valve has been adopted as a new inlet system to Yamaha's 175 ENDURO CT2. This, together with the 5-port cylinder, ensures excellence in steady engine performance from low to high speed running.

(2) Highly-dependable Yamaha Autolube

Yamaha Autolube provides superior engine lubrication that extends the service life of the engine.

(3) Easy Starting

The engine can be started by simply disengaging the clutch and kicking the kick pedal without shifting gears back to neutral. This is a valuable convenience to the rider.

(4) Powerful Brakes

Patented waterproof dustproof brake drums provide safe, fade-free braking on wet or dusty roads.

(5) Adjustable Rear Cushion

The rear cushions are adjustable to check positions. The rider can adjust spring tension to compensate for varying weights, speeds, and road conditions.

(6) Front Fork Design

The Yamaha 175 Enduro CT2 employs a front fork design well-known for its strength and superior handling characteristics. Its use assures the rider of the ultimate suspension for even the roughest terrain.

(7) Speedometer and Tachometer

A speedometer and tachometer are standard equipment. The individual units are separately mounted for maximum visibility. An additional feature of the speedometer is an odometer which can be reset by tenths to zero for trip or enduro purposes.

(8) Tires

The Yamaha CT2 is fitted with Dunlop Trials Universal tires as standard equipment. This particular tread is one of the most versatile available. It gives maximum trail traction, yet is compatible with road usage.

(9) Carburetor with built-in starter jet

Yamaha's carburetor is already well-known for providing easy starting. Equipped with this unique starter jet, the Yamaha CT2 is quick starting under all conditions.

II. Yamaha Autolube

What is Yamaha Autolube ?

Yamaha Autolube is an automatic lubrication system which obsoletes the conventional two-stroke pre-mixing system. Oil stored in the oil tank is metered automatically to the engine, by an oil pump, with the quantity varying according to engine speed and load.

The heart of the system is the compact, precision-built oil pump. Driven off the engine crankshaft through reduction gears, the varying oil needs are regulated by the pump which feeds the oil directly to the engine. Regulation is controlled through engine rpm's and throttle setting.

Features :

Yamaha Autolube eliminates the lubrication problems peculiar to two-stroke engines with the conventional "pre-mixing" system. Oil is never contaminated by gasoline prior to delivery to the engine, nor is it subject to de-naturing through storage in the gas tank.

1. The Autolube system results in:

- Oil consumption up to $\frac{1}{3}$ LESS than that of previous lubrication systems.
- Greatly reduced carbon build-up.
- Reduced exhaust emission.

2. The Autolube system provides:

- Fresh oil supply
- Complete lubrication due to large oil particles
- No worries about the compatibility of oil and oil-fuel mixing ratios

3. The Autolube system means:

- Fuel-"straight" gasoline only
- No pre-mixing of oil and gasoline

III. Nomenclature

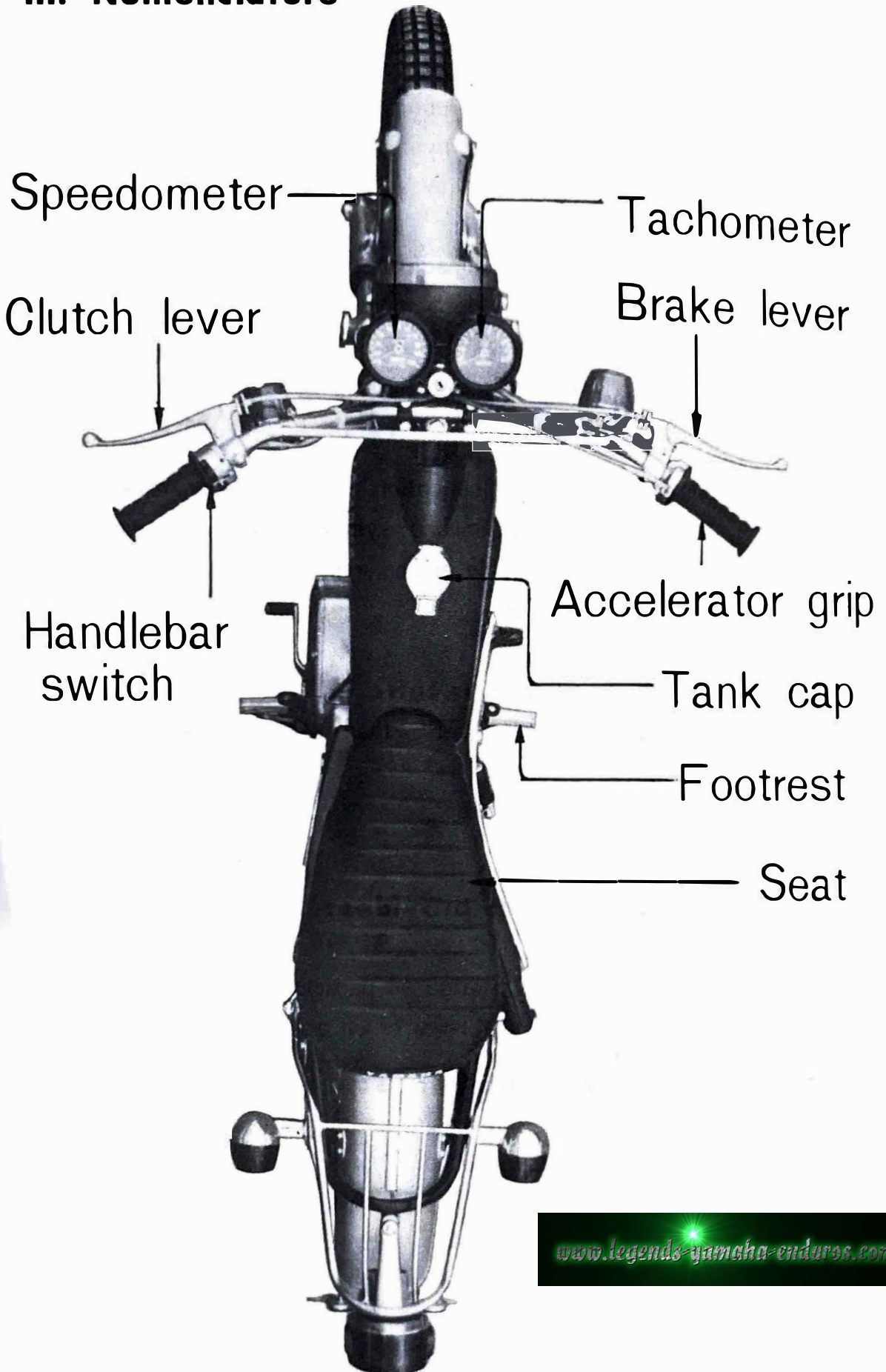

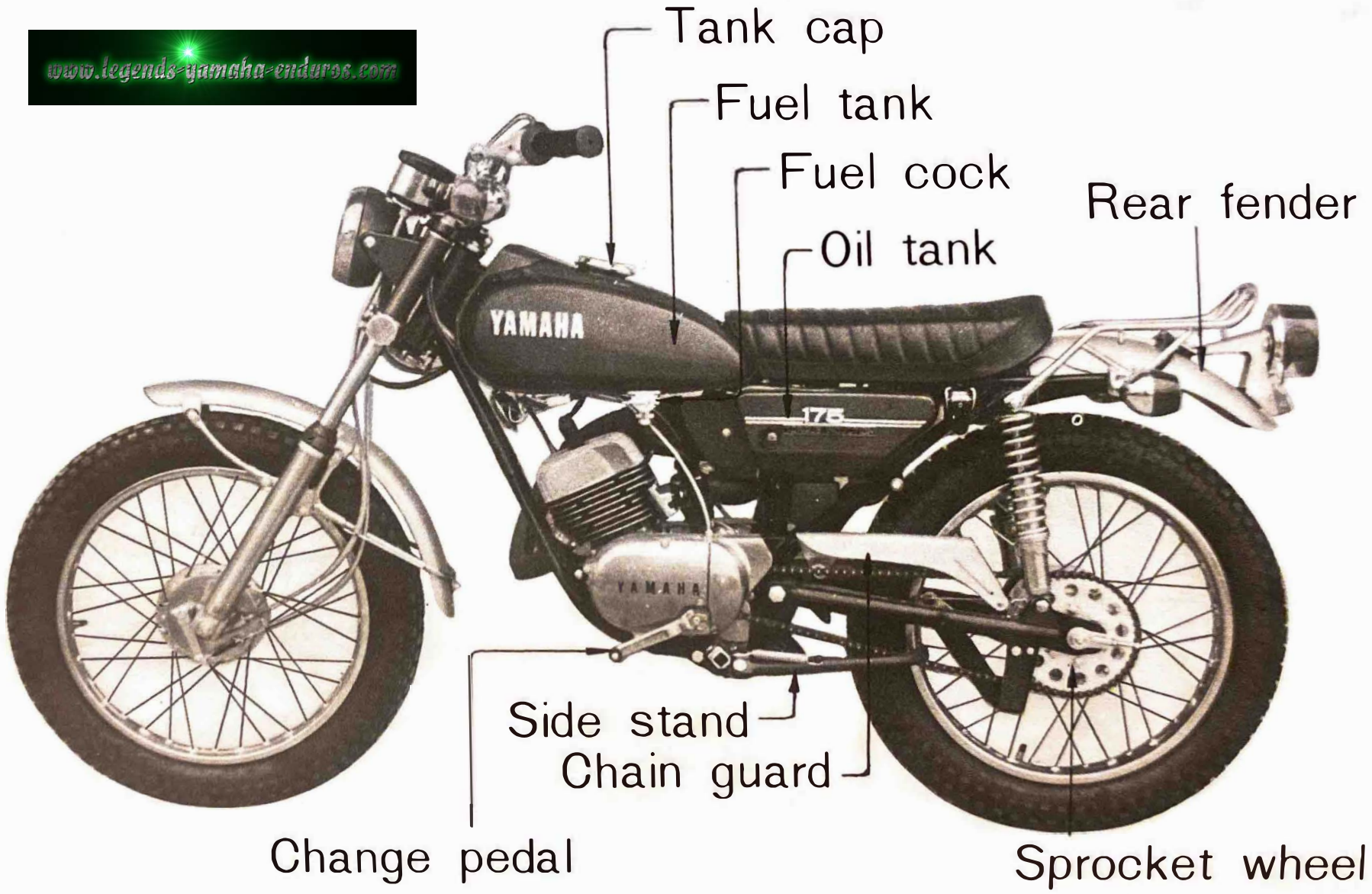

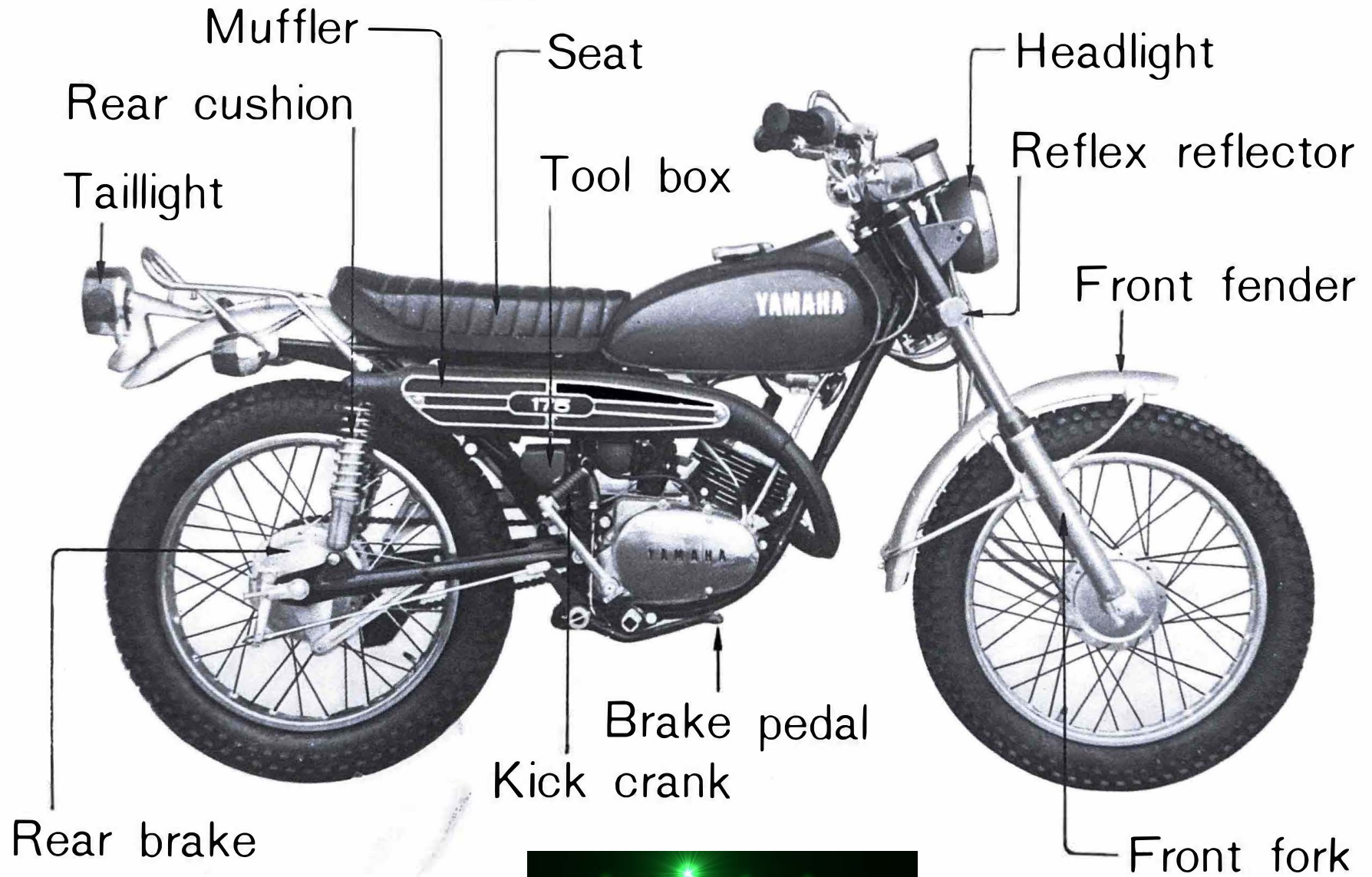

IV. Basic Instructions

1. Gasoline and Oil

The Yamaha Enduro 175 CT2 equipped with the Yamaha Autolube system, uses straight gasoline as fuel.

Gasoline: Use gasoline of 90 octane rating or more.

Use fuel with an octane rating of 90+. Some regular fuels and most mid-range have 90+ octane ratings. Ethyl grade fuels usually have octane ratings in excess of 100. In addition, they have considerable tetra-ethyl lead added which can cause spark plug problems. Whenever possible, use fresh, name-brand, gasoline.

Oil:

We recommend that your first choice be YAMALUBE, which can be purchased from any Yamaha dealer. If for any reason you use another type of oil, choose from the following list, which is in descending order of preference.

- 1) Another brand of 30 wt. two-stroke oil designed for air cooled engines.
- 2) A 30 wt. two-stroke oil designed for water cooled engines.
- 3) Any 30 wt., detergent type, automotive oil.

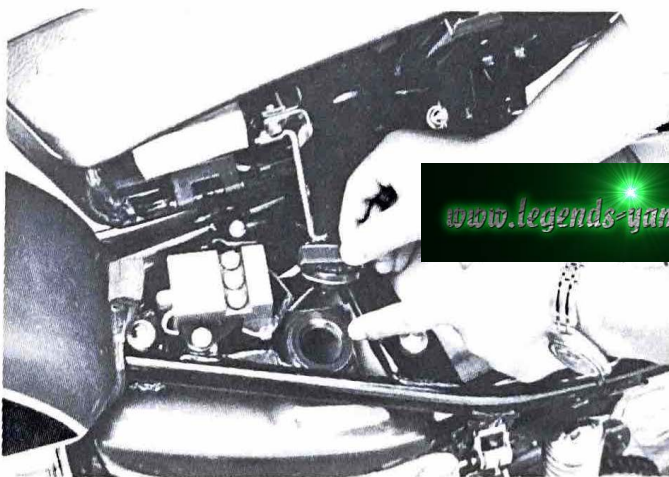

2. Familiarization of Equipment

(1) Main Switch

The main switch has three key positions, OFF, Ignition, and Ignition + Lights.

The following chart shows the key positions at which the various system are switched on or off. (The circle (○) denotes "Switch on".)

	OFF	I	II	Instructions
Engine		○	○	To start the engine, kick the kick pedal.
Neutrallight		○	○	The change pedal is in neutral.
Meterlight			○	The engine is running.
Headlight			○	The engine is running.
Taillight			○	
Stoptlight		○	○	The brake is applied.
Horn		○	○	The horn button is depressed.
Flasherlight		○	○	Turn on left handlebar switch.

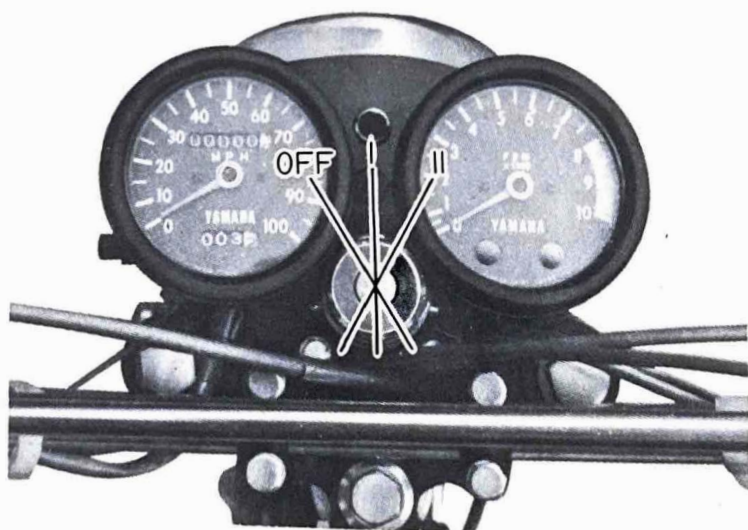

(2) Fuel Petcock

To allow the fuel to flow into the carburetor, turn the fuel petcock lever to ON. Should you run low of fuel while driving, turn it to RESERVE. The reserve gasoline will enable you to drive approximately 25 miles (40 km). When parking, the lever should be turned to STOP.

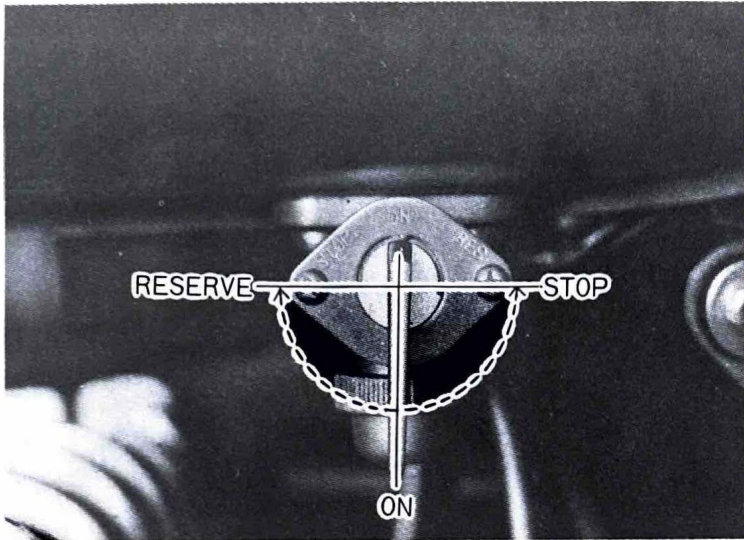

(3) Handlebar Switches

- To sound the horn, depress the horn button.
- To raise the headlight beam, pull the switch toward. To lower the beam, push the switch toward the front.
- To activate the flasherlight, move the turn signal switch on the left handlebar.

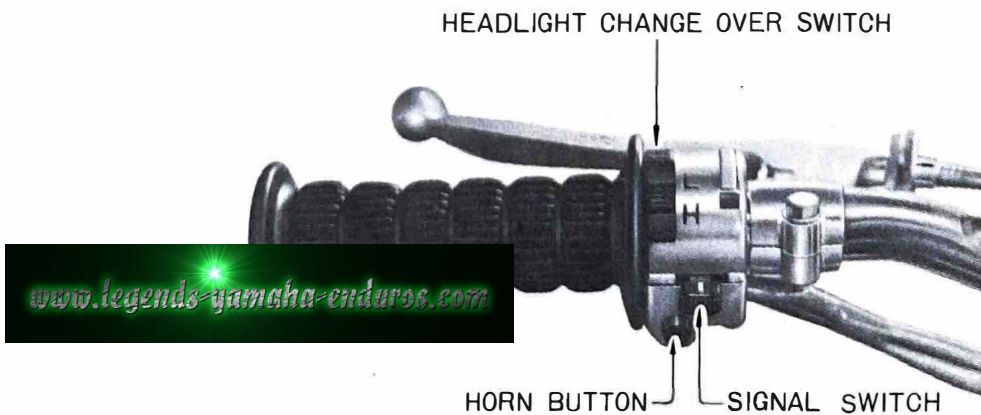

(4) Trip Total Meter

A trip total meter is built in the speedometer. It is designed to show the total mileage of each trip. Before starting a trip, set the trip total meter to the zero position.

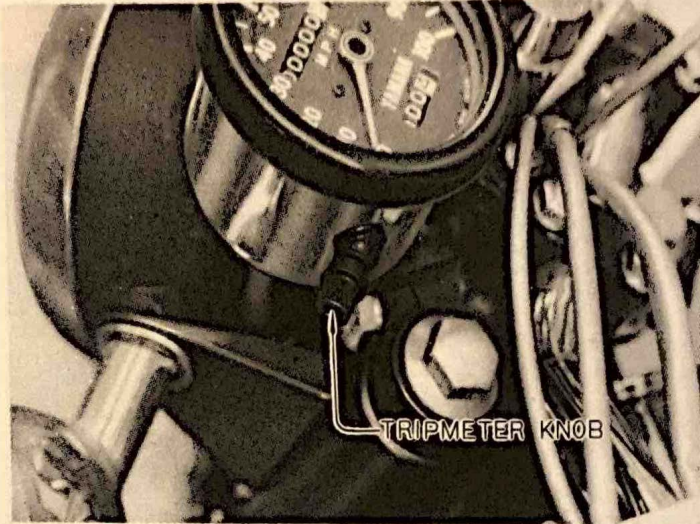

(5) Rear Cushions

The rear cushions can be adjusted according to load, road conditions, and rider preference.

- To adjust the rear cushion insert the screwdriver (service tool) buttend of the blade into the adjusting hole and then turn it in order to change the position of the toothed notch.

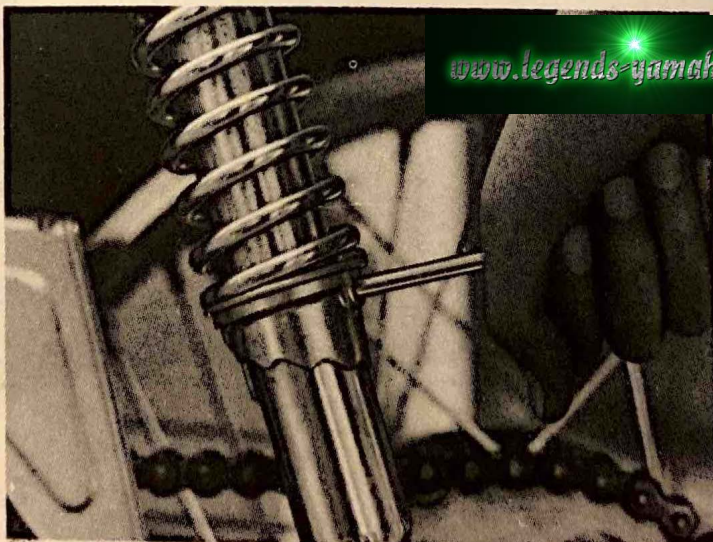

(6) How to Read the Tachometer

A tachometer is provided so that the rider can easily maintain engine RPM sufficient to keep the engine within the power curve.

The standard Yamaha CT2 is designed to run best in the power range between 3,000 rpm and 7,000 rpm.

Never lug your engine! It is recommended not to use red-zone 8,000 ~ 10,000 r.p.m.

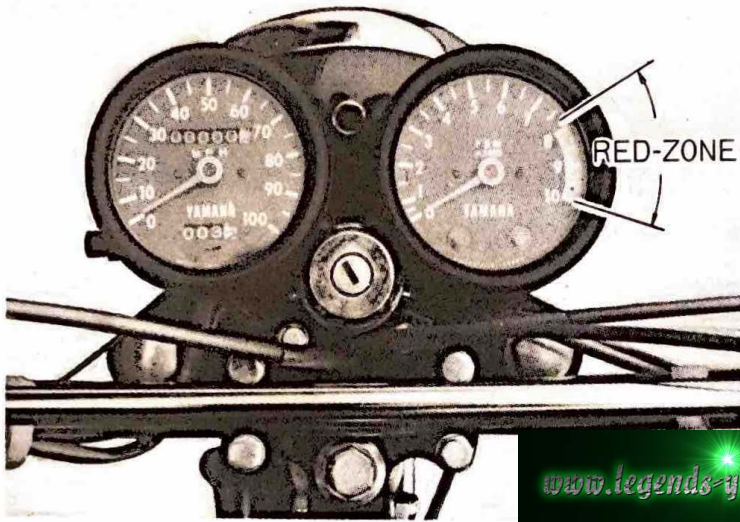

3. Pre-operation Check

You should check the following points before each usage.

(1) Is there sufficient fuel?

Make sure that there is sufficient fuel for your driving plan. Fill the fuel tank with gasoline only.

(2) Is there sufficient oil?

If the oil is below the center hole on the glass view port, refill the oil tank (See basic instruction for oil to use).

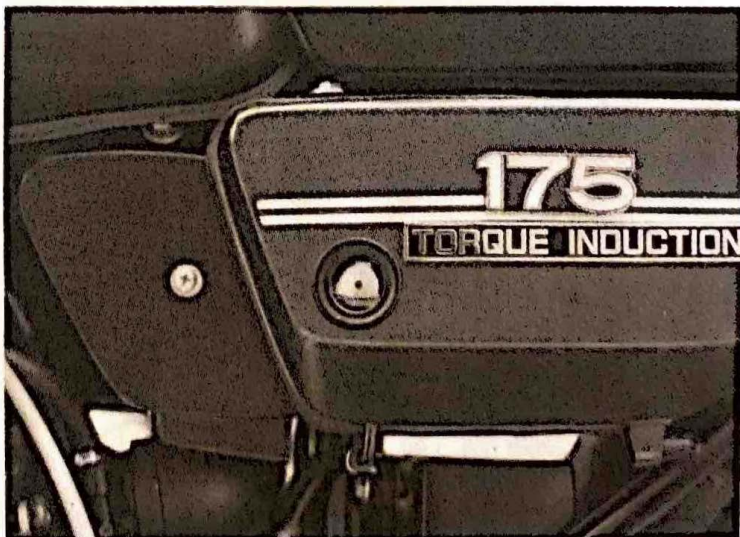

(3) Is the tire pressure correct?

The wrong tire pressure affects the riding comfort, steering, and life of tires.

Correct tire pressure:

Front—14 lbs/in² (1.0 kg/cm²) } For on-the-road-riding
Rear —17 lbs/in² (1.2 kg/cm²) }

When the tire pressure is reduced below the specified value because of some reason, the tire may slip around the rim. To prevent this slipping of the tire, bead stoppers should be used.

(4) Do the front and rear brakes work effectively?

Try the brake lever (right handlebar) and the foot brake (on the right side of the engine). Check to see if the stoplight is functioning.

(5) Do the lights and horn function well?

Check the horn, stoplight, headlight, meterlight, etc.

4. Operation

(1) Starting the Engine

The Yamaha 175 Enduro CT2 employs the kick starter system. The carburetor is provided with a starting system to produce the rich air-fuel mixture required for easy starting of the engine. It assures quick starting even in extremely cold weather.

Preparation for Starting

- Turn the fuel pet cock lever to the "ON" position.
- Insert the main switch key and turn it to the "Ignition" position.

Make sure the neutral light is on.

The 175 CT2 is equipped with a primary kick starter.

The engine can be started by kicking the kick pedal when the transmission is in neutral or by disengaging the clutch first if the transmission is in gear.

Starting When the Engine is Cold

Most engines are more difficult to start in cold weather. For easiest starting, a richer mixture of gas/air can be obtained by operating the starter lever.

- Depress the starter lever.
- Start the engine by kicking the kick pedal with the accelerator grip closed.



Starting When the Engine is Warm

When the engine is still warm from running or in warm weather:

- Don't use the starter lever.
- Slightly open the accelerator grip, and kick the kick pedal.

Warming Up

It is very important to allow a warming-up period of 2 minutes or so after starting the engine.

After the engine has started, the depressed starter lever must be released. Keep the accelerator grip open until the engine begins to run smoothly. Correct engine warm-up, along with periodic inspections, will assure a longer performance life from your engine.

(2) Operation Procedure

Shifting Gears:

The Yamaha 175 CT2 is equipped with a foot-operated, 5-speed transmission.

To shift into NEUTRAL, move the toe section of the change pedal downward into 1st and then raise it slightly to the neutral detent. The neutral position is between the First and the Second gear position.

FIFTH
FOURTH
THIRD
SECOND
NEUTRAL
FIRST

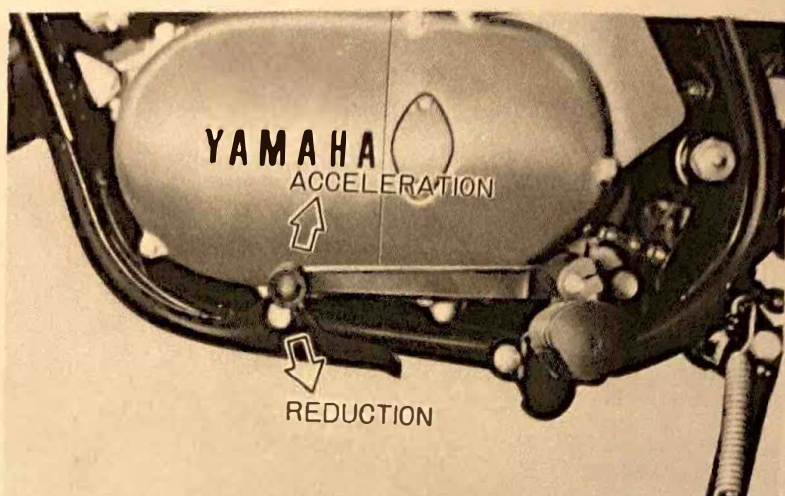

www.legends-yamaha-enduros.com

Shifting and Acceleration

Pull in the clutch lever to disengage the clutch. Press down on the toe section of the shift lever to engage first gear. Slowly twist the accelerator grip (engine speed begins to increase) and gently release the clutch lever.

Done properly, the machine will accelerate smoothly.

After starting off, accelerate to approximately 10 mph. Next, to shift into second gear, perform these steps simultaneously:

1. Disengage the clutch while twisting the accelerator grip to the closed position.
2. Shift into second gear by raising the toe section of the shift lever one full position (in this case, the neutral position is bypassed).
3. Increase engine speed slowly while gradually releasing the clutch lever. Accelerate to approximately 20 mph. To shift into third gear, repeat the same procedure. Use this procedure each time you want to shift into a higher gear.

You can also use the drag of the engine to slow down. Decelerating is accomplished by reversing the above procedure. Twist the throttle to the closed position, disengage the clutch, and depress the shift lever. Then slowly release the clutch.

Note: When shifting gears always remember that the tachometer is your guide to keep from over-revving and possibly damaging the engine. Keep the rpm's in the 3,000-7,000 rpm range except during break-in, which will be explained later.

Off-the-road Riding

When you ride your motorcycle over rough land, safety parts may break or fall off due to shocks from the ground or due to accidents such as falling, and breakage or loss of parts may result. It is advisable to remove all safety parts before you start riding.

Parts to be removed: Headlight, taillight, speedometer, tachometer, and side stand.

Caution on Riding over Paved Roads at High Speeds:

The CT2 is equipped with tires having a block pattern. As a result, the area where the tire contacts the ground is smaller compared with other types of tires. Therefore, take care to avoid slipping your motorcycle when you are cornering at high speeds and at sharp angles.

Driving on Hills

a. Going Uphill

When starting to climb a gentle grade, open the throttle little by little to avoid losing engine speed and power.

When climbing a steep grade, shift down from THIRD to SECOND or from SECOND to FIRST as required.

b. Going Downhill

On a long down grade or sharp descent, don't rely on the brakes alone, but use the engine compression as a brake: shift into THIRD or SECOND as required by the grade and close the throttle.

CAUTION: Never attempt to turn off the ignition switch on a long hill. This will only cause the spark plugs to foul.

Stopping

There are several ways to stop.

Pulling in the clutch lever and twisting the throttle grip in the closed direction will permit you to gradually glide to a stop.

Downshifting through the gears, using the drag of the engine to slow down is another. However, the best method, and the one most universally used, is to use both engine compression (downshifting through the gears as the machine slows) and the front and rear brakes.

When stopping, gradually apply the rear brake while twisting the throttle

grip in the closed direction. After the rear brake starts to take hold, gradually apply the front brake.

As the machine continues to slow, shift down through the gears, using engine compression to aid the slowing effect. When shifting down, watch the tach to see that the engine does not over-rev.

Note: During periods of Inclement weather, ice snow, rain, sleet, or ice, or on poor road surfaces where traction is minimal, or in a sharp corner, IT IS NOT ADVISABLE TO FIRMLY APPLY THE FRONT BRAKE. While it is true that the front brake supplies the greater portion of braking power, it is also true that stability can be upset very easily if it is used incautiously under the above conditions.

5. Break-in Procedure

THERE IS NEVER A MORE IMPORTANT PERIOD IN THE LIFE OF YOUR CT2 THAN THE PERIOD BETWEEN ZERO AND FIVE HUNDRED MILES. For this reason we ask that you carefully read the following material.

Because the engine is brand new, you must not put an excessive load on it during the first several hours of running. You could look at it in this manner: During the first 500 miles the various parts in the engine wear and polish themselves to the correct operating clearances. During this period prolonged full throttle operation, or any condition which might result in excessive head and cylinder temperatures, must be avoided. However, momentary full throttle operation (five seconds maximum) does not harm the engine. Each full throttle acceleration sequence should be followed with a substantial 'rest period' for the engine by cruising at lower rpm's so the engine can rid itself of the temporary build up of heat. The method for breaking in an CT2 is quite simple.

1. Zero to fifty miles:

Avoid operation above 4,000 rpm. Allow a cooling off period of five to ten minutes after every hour of operation. Vary the speed of the motorcycle from time to time. Do not operate it at one, set, throttle position.

2. Fifty to 100 miles:

Avoid prolonged operation above 5,000 rpm. Allow the motorcycle to rev freely through the gears but do not use full throttle at any time.

3. 100 to 500 miles:

Avoid prolonged full throttle operation. Avoid cruising speeds in excess of 7,000 rpm.

4. 500 miles and beyond:

Avoid prolonged full throttle operation. Avoid cruising speeds in excess of 8,000 rpm's. Vary speeds occasionally.

V. Service Tools

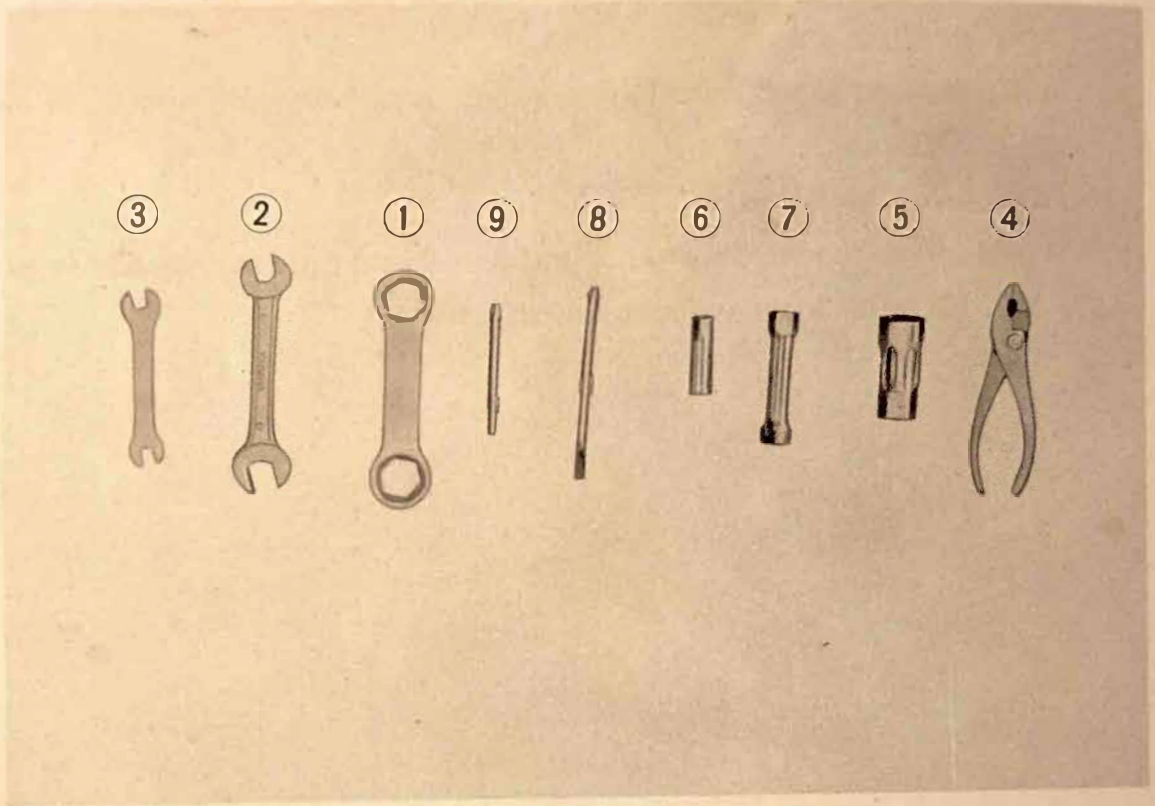

- ① 22×26 mm. Double-ended Spanner
- ② 13×17 mm. Spanner
- ③ 8×10 mm. Spanner
- ④ Plier
- ⑤ 17×21 mm. Socket wrench
- ⑥ 10 mm. Socket wrench
- ⑦ Screwdriver handle and 13 mm. socket wrench.
- ⑧ ⊕ ⊖ Screwdriver
- ⑨ ⊕ Screwdriver

VI. Inspection and Service

This chart should be considered strictly as a guide to general lubrication and maintenance periods. You must take into consideration that weather, terrain, geographical locations, and a variety of individual uses all tend to demand that each owner alter this time schedule to match his environment. If the motorcycle is continually operated in an area of high humidity, then all parts must be lubricated much more frequently than shown on the chart to avoid the ravages of water on metal parts. If you are in doubt as to how closely you can follow these time recommendations, check with the dealer in your area.

Greasing and Oiling

			300 miles	1,000 miles	2,000 miles	every 2,000 miles	every 4,000 miles
1	Brake cam shaft	G		○	○	○	
2	Wheel bearing	G			○		○
3	Brake wire	M/O		○	○	○	
4	Clutch wire	M/O		○	○	○	
5	Tacho, speedometer cable	G			○	○	
6	Meter gear unit	G			○	○	
7	Steering ball race	G					○
8	Front fork oil	M/O	○		○	○	
9	Brake pedal shaft	G		○	○	○	
10	Change pedal shaft	M/O, G			○	○	
11	Axle grip	G		○	○	○	
12	Transmission oil	M/O	○	○	○	○	
13	Dynamo lubricator	G					○
14	Stand shaft	M/O, G					○
15	Rear arm pivot shaft	G			○	○	
16	Drive chain	M/O		○	○	○	

Check Point Periodic Inspection Guide

		Pre-operation check	300 miles	1,000 miles	2,000 miles	every 2,000 miles	every 4,000 miles
1	Front and rear brake adjustment (F. R)	○	○	○	○	○	
2	Clutch adjustment		○	○	○	○	
3	Transmission oil replacement	○	○	○	○	○	
4	Front fork oil replacement		○		○	○	
5	Grease up			○	○	○	
6	Battery electrolyte refilling	○	○	○	○	○	
7	Spark plug cleaning	○	○	○	○	○	
8	Ignition timing adjustment			○	○	○	
9	Fuel pet cock cleaning		○	○	○	○	
10	Carburetor adjustment			○	○	○	
11	Carburetor cleaning						○
12	Air cleaner cleaning	○		○	○	○	
13	Cylinder, piston cleaning			○		○	
14	Silencer muffler cleaning			○		○	
15	Drive chain adjustment, oiling		○	○	○	○	
16	Autolube pump adjustment	○	○	○	○	○	
17	F. R wheel inspection	○		○	○	○	
18	Bolt, Nut retightening		○	○	○	○	
19	Spoke, Rim inspection			○	○	○	

Be sure to check the above points before long-distance touring.

1. Inspection and Adjustments

The methods of inspection and adjustment are discussed below. This information will be of value in your daily inspections.

Front Brake Cable Maintenance:

This cable needs periodic lubrication. To release one end of the cable for lubrication, follow the same procedures as listed in the CLUTCH CABLE MAINTENANCE section.

Removal of the front brake cable requires that you must first disconnect the cable at the lever, as was just explained. To disconnect it at the front hub, you have to screw the cable adjuster in so that there is plenty of cable slack right at the brake. Line up the slots in the adjuster, lock nut, and hub housing, and slip the cable out of the adjuster and out through the slots.

Front Brake Adjustment:

As with the clutch, there are also two adjustments to check.

These two adjustments are located at the brake lever and at the front hub. In this situation though, only one brake adjustment is necessary, using either of these two places to make the adjustment. Preferably, it is much easier to make it at the brake lever. This is done by loosening the lock nut, and screwing the adjuster in or out until you have 3/16" free play.

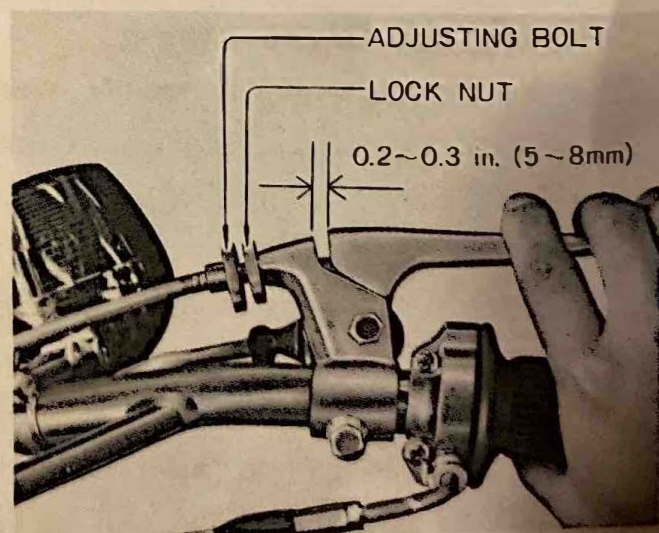
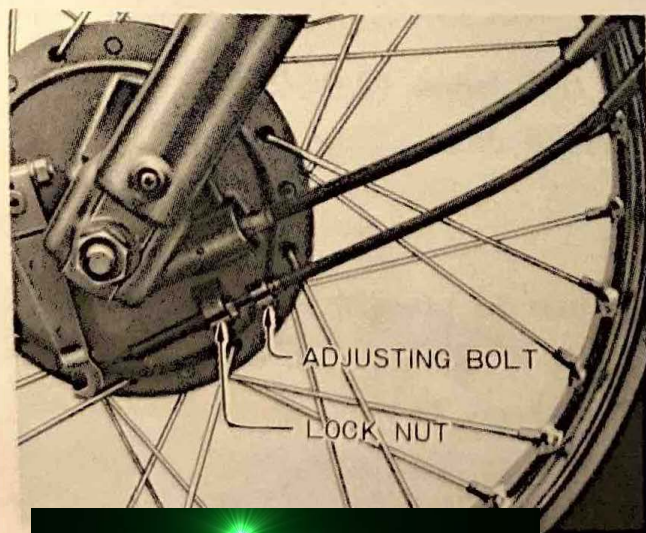

www.legends-yamaha-enduros.com

Rear Brake adjustment:

The free correct play of the rear brake pedal is approximately 1 in. (25 mm). To adjust the play, turn the adjusting nut attached to the rear brake cable end one-half turn at a time.

After the adjustment, check the stoplight to see if it functions properly.

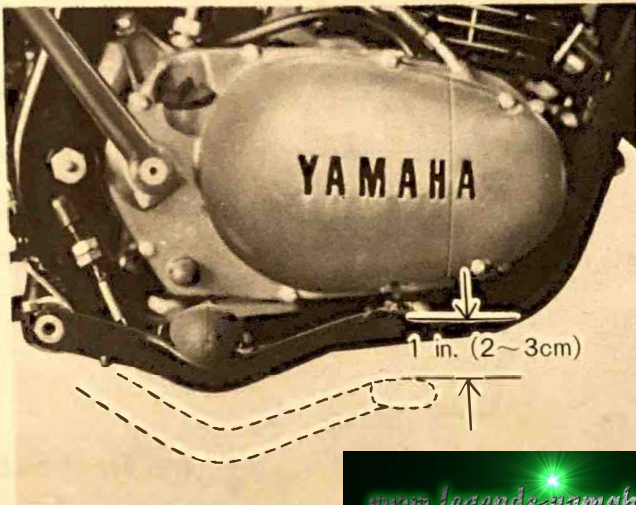

www.legends-yamaha-enduros.com

Note: This adjustment must be checked any time the chain is adjusted or the rear wheel is removed.

Checking the Brake Lining:

Disassemble the wheel assembly every 2,000 miles (3,000 km), check it for wear and clean the brake shoe and brake drum. Take care not to get any oil on the lining friction surface.

Clutch Cable:

The clutch cable requires periodic lubrication to prevent the cable strands from rusting or hanging up in the casing. First, disconnect the cable from the clutch lever by screwing the adjuster all the way back to the cable casing. This will provide enough free play in the cable for you to slip the cable out of the lever holder through the slot in the lock nut, adjuster, and holder. Hold the cable upright and allow several drops of liquid graphite to flow down the cable. Hold the cable upright for several minutes to permit complete lubrication.

If the cable needs to be replaced, then perform the steps above and disconnect the cable at the lever. Next, disconnect the cable at the engine. Begin by taking off the cover that houses the clutch activating mechanism (left side of the engine). Looking at the inside of this cover, you will see the clutch actuating arm. Push the arm up and lift the cable end off. Removing the old cable and hooking up the new one will take but a few moments.

Clutch Cable Adjustment :

The CT2 has two clutch adjustments. The first, located at the handlebar clutch lever, is used to take up slack from cable stretch and to provide sufficient free play so that the clutch engages and disengages completely. The picture below illustrates all the parts involved in making the adjustment.

1. First, loosen the lock nut. Then turn the adjuster either in or out depending on which direction is necessary to arrive at 2-3 mm (1/16"-1/8") free play.
2. The second adjustment is located behind the clutch adjust cover. Removing the cover will expose the adjusting set screw and lock nut. Loosen the lock nut, rotate the set screw in until it lightly seats against a clutch push rod that works with the set screw to operate the clutch. Back the set screw out 1/4 turn and tighten the lock nut. This adjustment must be checked because heat and clutch wear will affect this free play, possibly enough to cause incomplete clutch operation.

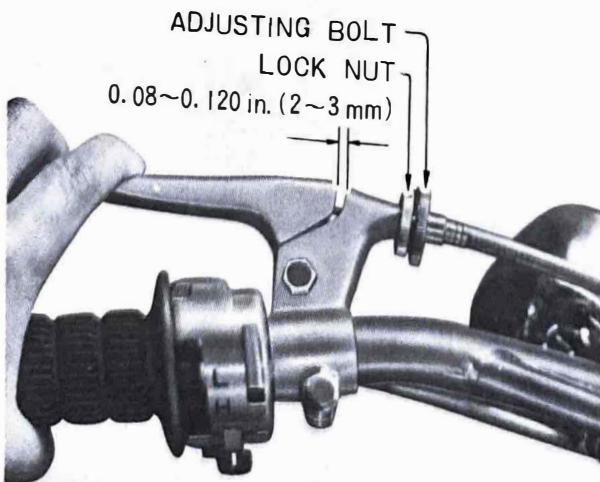

Replacing the Gear Oil

During the break-in period, replace the gear oil after 30 days from the date of purchase or after 300 miles (500 km) running.

After the first time, See page 21. Transmission oil replacement.

To drain the oil from the bottom of the crankcase, remove the oil drain plug.

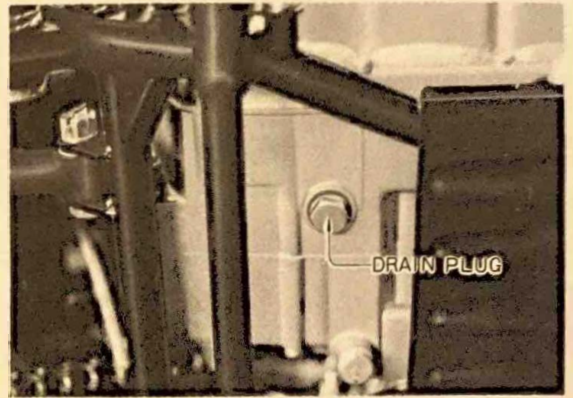
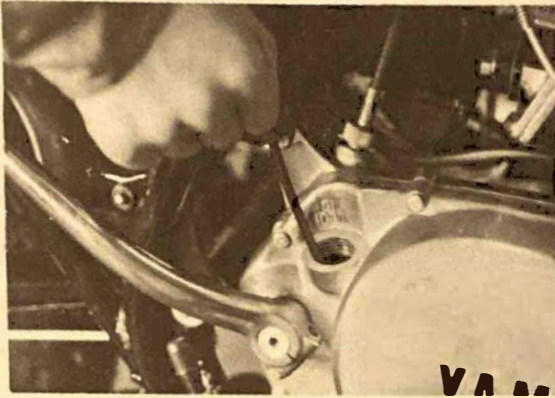

After draining the oil, fully tighten the oil drain bolt, and fill with the specified amount of new oil.

OilSAE 10W/30 MOTOR OIL

Oil Amount0.7~0.8 quarts (0.7~0.8 litres)

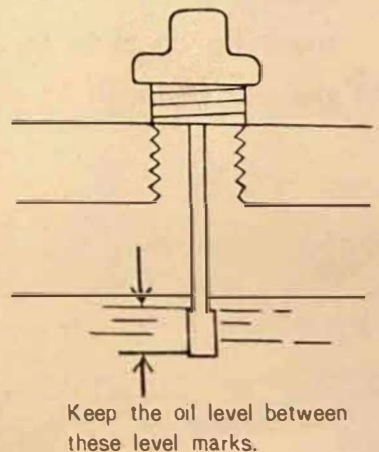
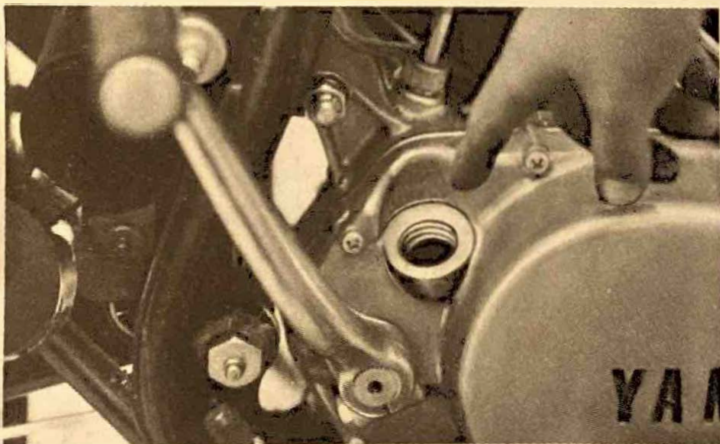

When checking transmission oil level, with the dip stick, let the unscrewed dip stick just rest on the case threads. Also, be sure the machine is positioned straight up and on both wheels. The oil level should indicate on the stick between the minimum and maximum marks.

Note: DO NOT ADD ANY CHEMICAL ADDITIVES. TRANSMISSION OIL ALSO LUBRICATES THE CLUTCH AND ADDITIVES COULD CAUSE THE CLUTCH TO SLIP.

Checking the Battery electrolyte

The life of your battery depends greatly on how well you keep it serviced. In order to service it completely and correctly, there are certain facts that you must know.

1. Always keep the battery fluid level between the "Maximum" and the "Minimum" level. It should be checked at least once a month, and more often during hot weather. If the battery needs filling, use distilled water. Do not use tap water as it usually contains minerals that can be harmful to the life of the battery.

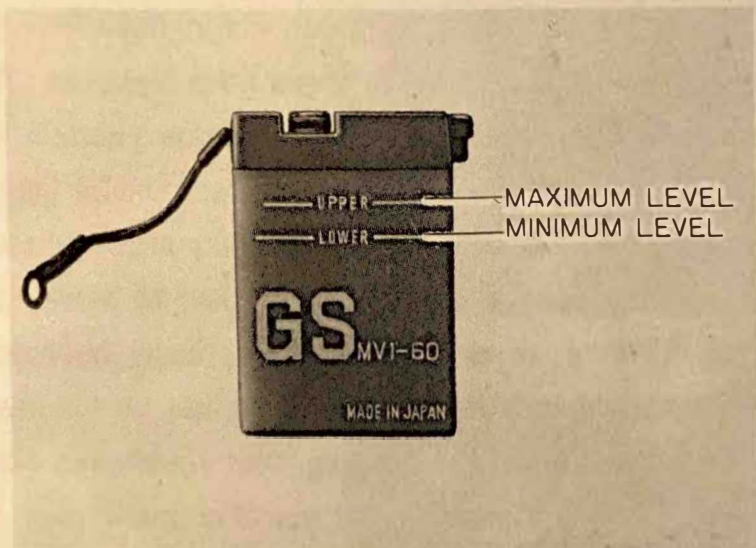

2. If for any reason the battery has become discharged, and you are going to charge it yourself, use a "trickle charger" that has no more than a one amp per hour rating. Also, make sure that all the battery caps have been taken off and that the rubber battery breather tube is not clogged or pinched shut. A charging battery creates gas, and pressure could build up in the battery if all the outlets were plugged up.
3. If the motorcycle is to be stored for more than a month, then remove the battery, have it fully charged, and store it in a cool dry storage area. If storage time is going to be lengthy, it is best to leave the battery with your dealer with specific instructions to recharge the battery every month or so. This procedure is necessary to insure maximum battery life.
4. When reinstalling the battery, be sure to hook up the RED lead to the positive terminal and the BLACK lead to the negative terminal (the polarity of each is stamped just below each terminal).

Checking the Spark Plug

The spark plug in your machine can tell you a great deal as to how the engine is operating when you know how to “read” the plug. If the engine is operating correctly, and if it is being ridden correctly, then the tip of the white insulator in the spark plug will be a light tan color (standard plug is NGK B-8ES). If, when you remove the spark plug, it is very dark brown or black, then a plug with a hotter heat range might be needed. The situation is quite common during the engine break-in period. If the insulator tip shows a very light tan color, or is actually white, or if the electrodes begin to melt, then a spark plug with a colder heat range is required. Again, if the spark plug insulator tip does not have a light tan color, have your dealer install a spark plug with a different heat range to correct the situation. Do not attempt to experiment with different heat range spark plugs yourself, as it takes an experienced eye to gauge which spark plug to use, and to gauge if the spark plug is actually at fault. It is all right though for you to replace the standard plug. Engine conditions can cause any spark plug to slowly break down. If deposits begin to build up, or if the electrodes finally become too worn, or if for any reason you believe the spark plug to not be functioning correctly, replace it. Be sure, when replacing the plug, that you always clean the gasket surface, that you use a new gasket, and that the spark plug is torqued to 20-25 ft/lbs. Also wipe off any grime that might be present on the surface of the spark plug. The plug can be taken out to be cleaned and gapped. As long as deposit build-up on the insulator is not extreme, you can use a spark plug cleaner to quickly remove the deposits. Use a wire type feeler gauge to set the electrode gap at 0.020”-0.024” (0.5 mm-0.6 mm.)

Standard spark plug B-8ES

0.020~0.024 in.
(0.5~0.6 mm.)

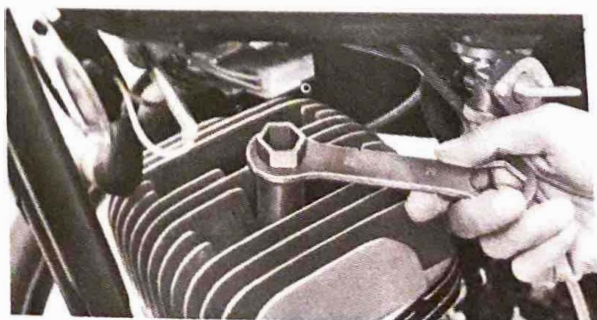
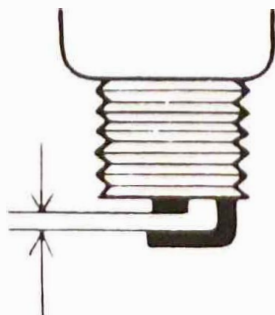

Air Filter

This model is equipped with a reuseable, oil impregnated, foam air filter. It must be removed and cleaned at least once a month, more often if the motorcycle is ridden mainly in the dirt = preferably each time after you spend an entire day in the dirt (8-10 hours operation).

a) Remove the air cleaner case cap

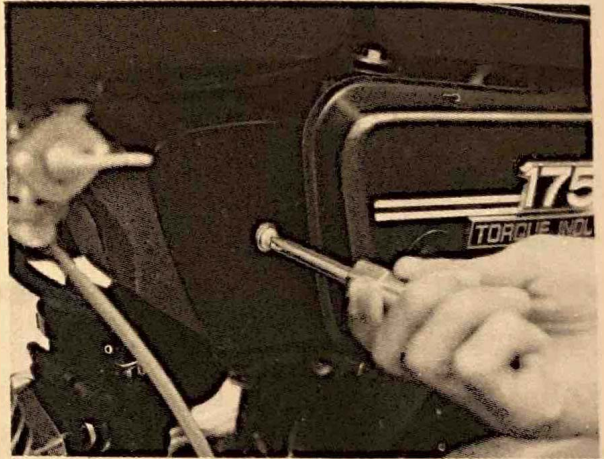

b) The cleaner element can be pulled out.



Carburetor adjustments

Each carburetor is set by the factory after careful tests.

Except for the following, do not change the carburetor setting without consulting your local Yamaha dealer.

1. Idle mixture

To set the idle mixture you must turn the idle mixture screw (#1) in until it lightly seats, then back it out $1\frac{3}{4}$ turns—no more or no less. This is a factory setting that can be set with the engine stopped, and no further adjustment is required.

2. Idle speed

Start the engine and let it warm up. Next, screw the idle speed screw (#4) in or out, whichever direction is necessary for the engine to idle between 1,300 and 1,400 rpm (check tachometer).

3. Throttle cable slack

After engine idle speed has been set, then loosen the cable adjuster lock nut (#3) and turn the adjuster (#2) on top of the carburetor until there is 1mm (.04") of slack in throttle cable 'B'. Retighten the lock nut. Make the second throttle cable slack adjustment right at the throttle grip. There is a lock nut and adjuster where cable 'A' meets cable guide 'A'. Loosen the lock nut and turn the adjuster until there is .5-1.0 mm (.02-.04") slack in throttle cable 'A'. Retighten the lock nut.

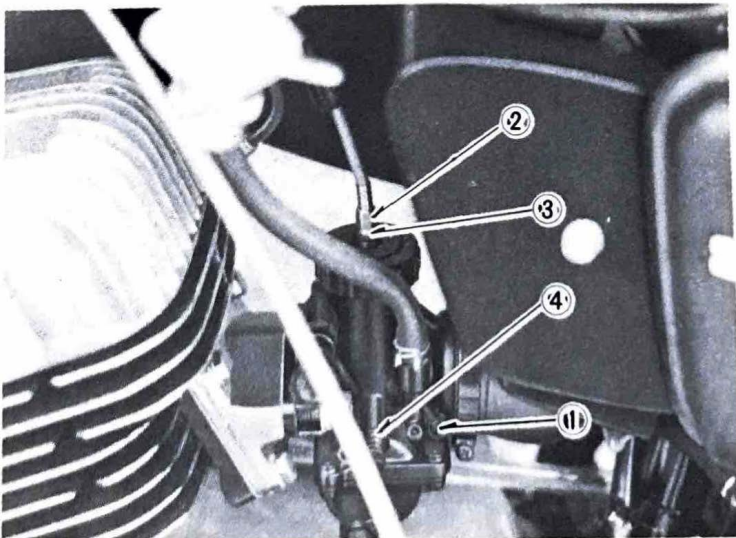

Note: To measure the amount of cable slack, slide the cable back and forth over the throttle wire, and see so much end gap exists between the cable end and top of the carburetor (or cable guide 'A', if checking throttle cable 'A' slack).

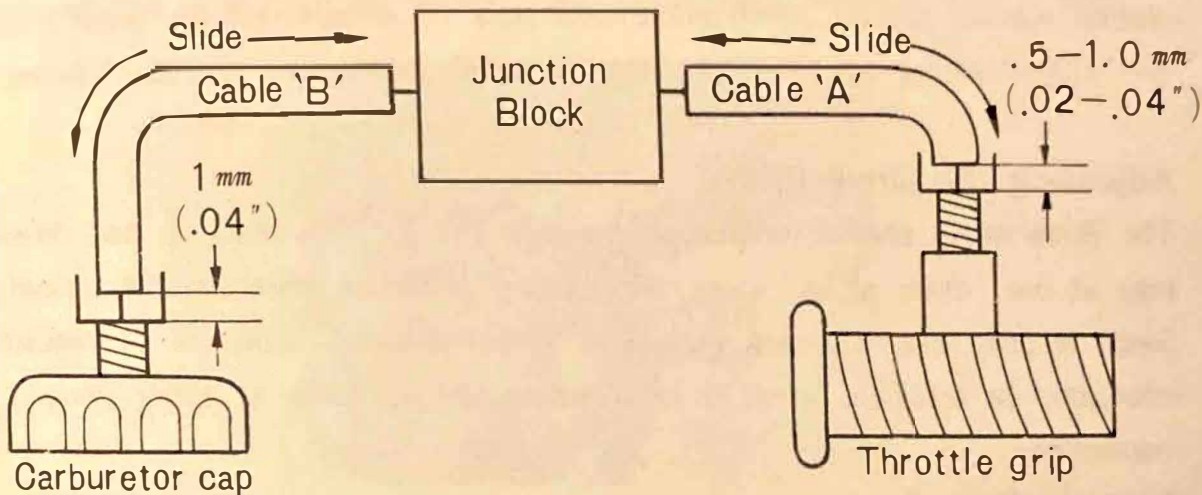

Autolube Cable Adjustment

- a. Adjust the pump cable so that the marking (arrow) on the Autolube pump adjustment pulley is aligned with the guide pin. Begin by fully closing the accelerator grip, then slowly turning it back again so that the slack in the throttle cable is completely taken up. Next, adjust the pump cable so that the marking on the pump adjustment pulley will be aligned with the guide pin. The point of adjustment is at the end of the cable, just before it enters the case. Loosen the lock nut and screw the adjuster in or out, whichever direction is necessary to obtain the correct adjustment.

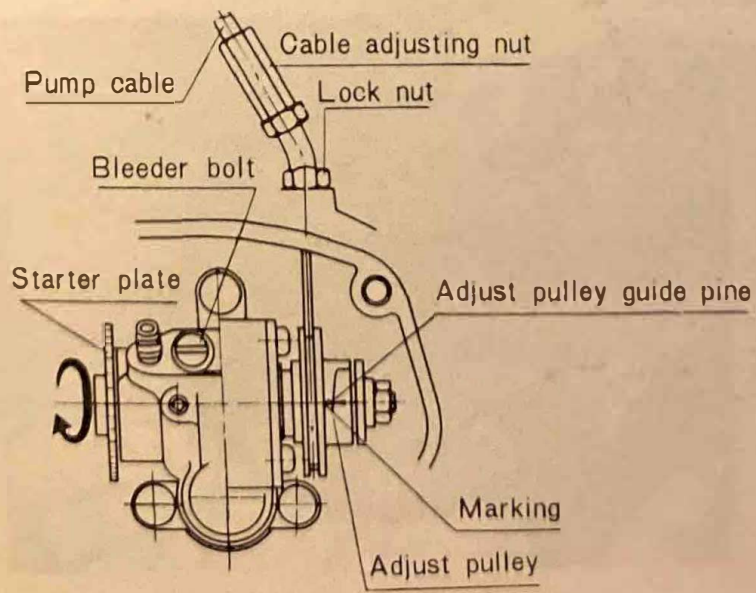

Important Note :

If the pump runs out of oil, the pump must be bled to release air trapped in the pump. Remove the Phillips-head bleed screw, twist the throttle to full open position (turns the Autolube pump to maximum stroke), and rotate the plastic manual starter pump plate until only oil comes out the bleed hole (air stops coming out with the oil). Reinstall and tighten the bleed screw.

Adjusting the Drive Chain

The drive chain should have approximately $1\frac{1}{4}$ in. (30 mm) up and down play at the center of the lower section with the rear wheel on the ground. Since a dirty chain causes excessive sprocket wear, apply oil at regular intervals. In addition, wash it in gasoline before oiling at every periodic inspection.

Adjusting Chain Tension:

- a. Loosen the rear brake adjusting screw.
 - b. Loosen the tension bar nuts.
 - c. Loosen the rear axle nuts ①.
 - d. Loosen the chain adjusting bolt lock nuts ②, and shift the wheel shaft so that both ends of the wheel shaft are positioned evenly by utilizing the marks on the swing arms.
 - e. After adjusting, tighten the tension bar lock nuts ②, and axle nut ①.
 - f. Adjust the play of the brake pedal.
- * After these adjustments, check the play of the brake pedal and stop-light operation.

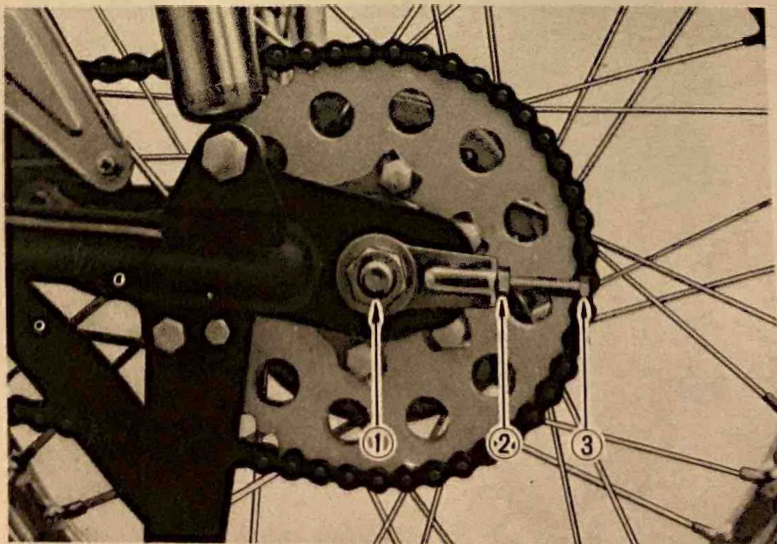

Decarbonization

To remove the inner cylinder from the muffler, remove the set screw and pull out the tail pipe.

Remove carbon with a wire brush.

Check the inner bore for carbon. If it is clogged, clean it with a wire.

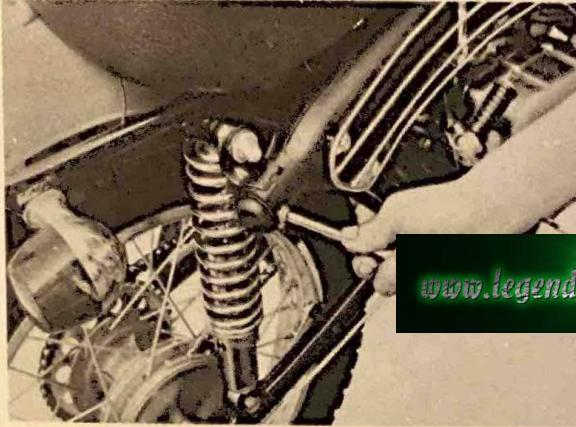

Cleaning the Combustion chamber and Piston

Carbon accumulation covering the combustion chamber and piston will result in loss of power, engine knock, overheating, and other problems.

- a. Remove the cylinder head and remove carbon from the combustion chamber.
- b. Remove carbon from the piston head.

To clean them, use a scraper and rags dampened with solvent.

- c. The head bolts must be torqued when the head is reinstalled. Torque the bolts in pattern to a setting of 180 in/lbs.

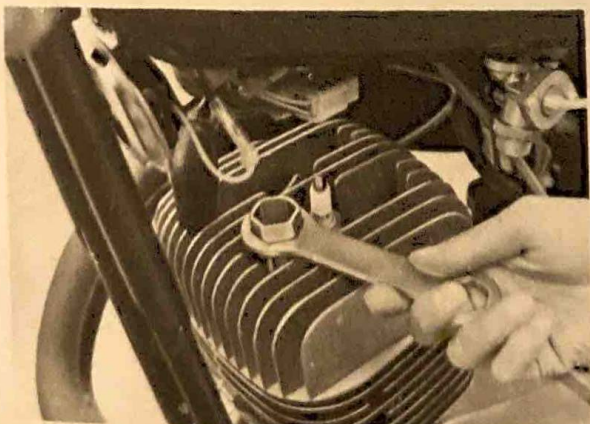

Cleaning the Fuel Pet Cock Filter

The fuel pet cock filter removes impurities from gasoline before they flow into the carburetor. A dirty filter clogs the system, and as a result, the engine will not run properly. Clean it from time to time. Remove the cup from the fuel cock and remove the filter.

Wash it carefully in gasoline and reinstall.

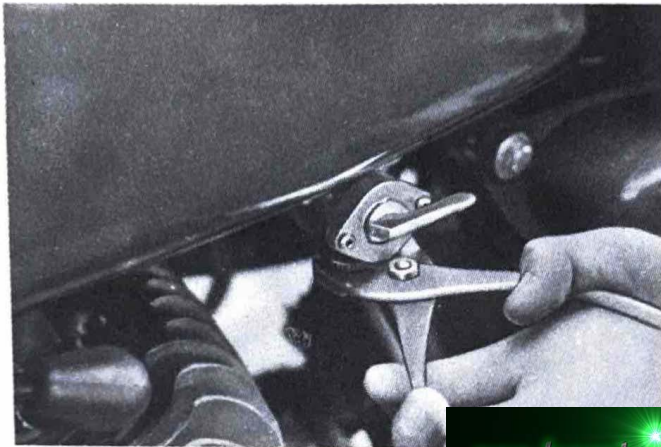

www.legends-yamaha-enduros.com

Maintenance (Trips):

Prior to starting out on a major trip, or at intervals of one month or 1,000 miles, all of the fittings on the motorcycle should be checked for tightness.

These include:

1. Chain adjust bolt lock nuts.
2. Headlamp, front fork and front axle nuts.
3. Speedometer and tachometer fittings.
4. Carburetor clamp screws.
5. Side cover and air cleaner securing screws.
6. Engine mounting bolts.
7. Foot peg and exhaust system securing bolts.
8. Crankcase cover Allen screws.
9. Rear axle securing nut.
10. Front and rear fender mounting bolts.
11. Taillight and license plate mounting bolts.

TORQUE:

All fittings require a minimal amount of torque during tightening to keep them from vibrating loose. Excessive tightening will only lead to stripped threads and broken studs. As a rule of thumb, use the following tightening chart:

STUD SIZE	TORQUE
6 mm	90 in/lbs.
7 mm	135 in/lbs.
8 mm	180 in/lbs.
10 mm	300-350 in/lbs.
12 mm	350-400 in/lbs.
14 mm	400-450 in/lbs.
Axle Nuts	500-600 in/lbs.



WIRING DIAGRAM

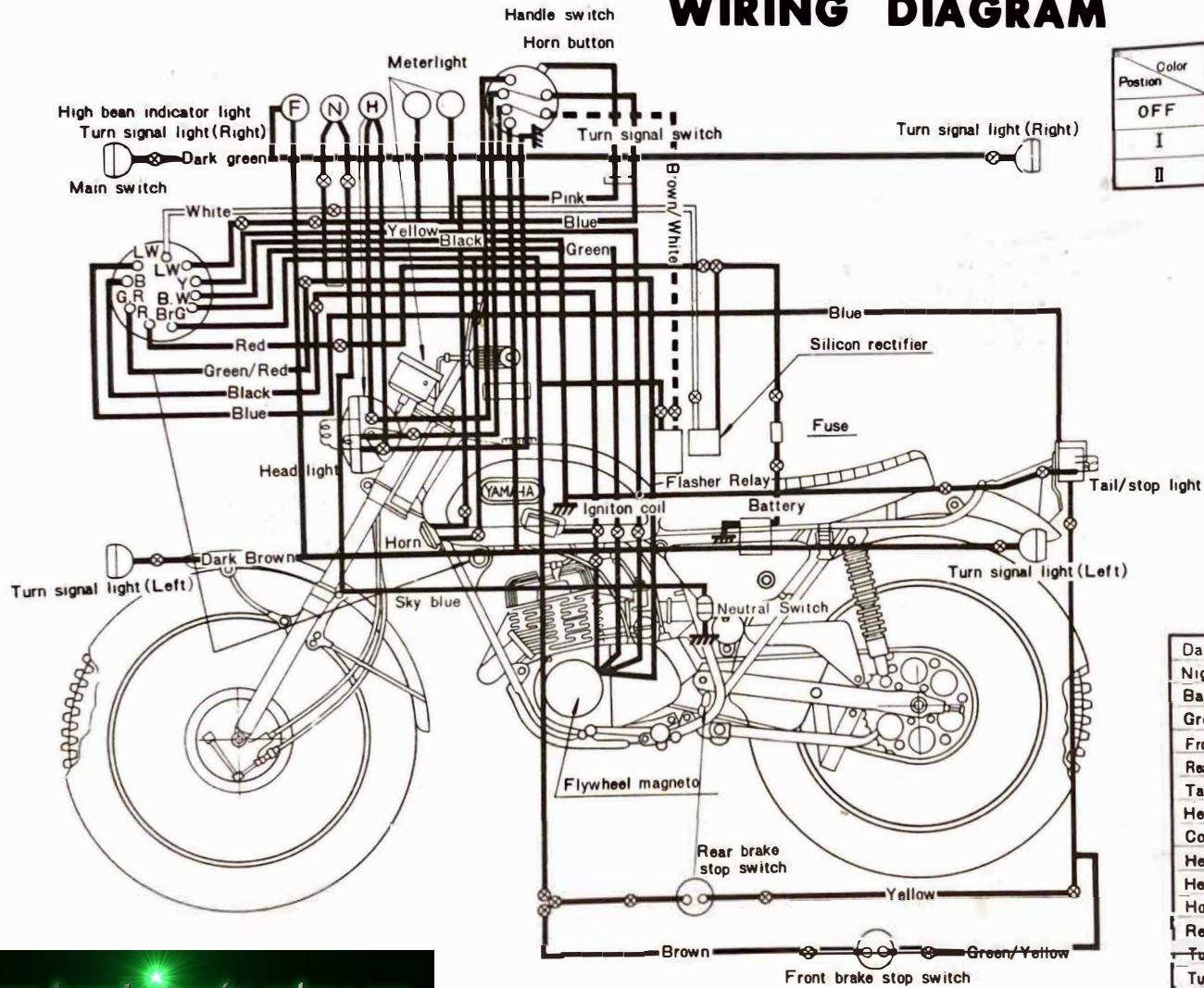

Color	E	B	R	Br	L	G	W	GR	LW	Y
Position										
OFF	○	○								
I			○	○		○	○			
II			○	○	○			○	○	○

Chart of wire colors

Daytime charging circuit	Green
Night time charging circuit	Green/Red
Battery(s+) circuit	Red
Ground circuit	Black
Front brake stop light circuit	Green/Yellow
Rear brake stop light circuit	Yellow
Tail light circuit	Blue
Head/Meter light circuit	Blue(L.W)
Common circuit	Brown
Head light main circuit	Yellow
Head light sub circuit	Green
Horn circuit	Pink
Rectifier circuit	White
Turn signal light (Right) circuit	Dark green
Turn signal light (Left) circuit	Dark Brown
Turn signal relay circuit	Brown/White

Stopping Distance

This figure indicates braking performance that can be met or exceeded by the vehicles to which it applies, without locking the wheels, under different conditions of loading and with partial failures of the braking system. The information presented represents results obtainable by skilled drivers under controlled road and vehicle conditions, and the information may not be correct under other conditions.

Description of vehicles to which this table applies: Yamaha motorcycle CT2

A. Fully Operational Service Brake

Load

Light

Maximum

190

210

0 100 200 300

Stopping Distance in Feet from 60 mph.

www.legends-yamaha-enduros.com

Acceleration and passing ability

This figure indicates passing times and distances that can be met or exceeded by the vehicles to which it applies, in the situations diagrammed below.

The low-speed pass assumes an initial speed of 20 mph and a limiting speed of 35 mph. The high-speed pass assumes an initial speed of 50 mph and a limiting speed of 80 mph.

NOTICE: The information presented represents results obtainable by skilled drivers under controlled road and vehicle conditions, and the information may not be correct under other conditions.

Description of vehicles to which this table applies: Yamaha motorcycle CT2

Summary table:

Low-speed pass..... 380 feet: 8.2 seconds
High-speed pass..... 1750 feet: 21.0 seconds

LOW-SPEED

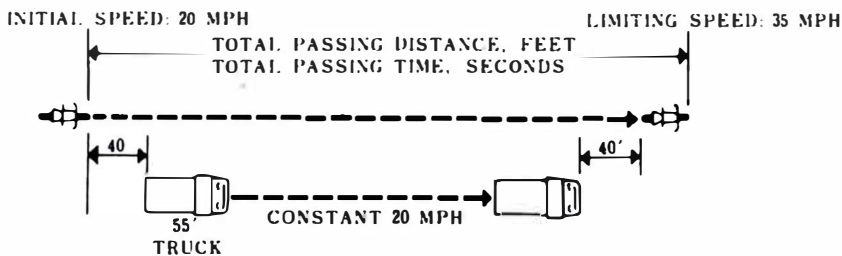

HIGH-SPEED

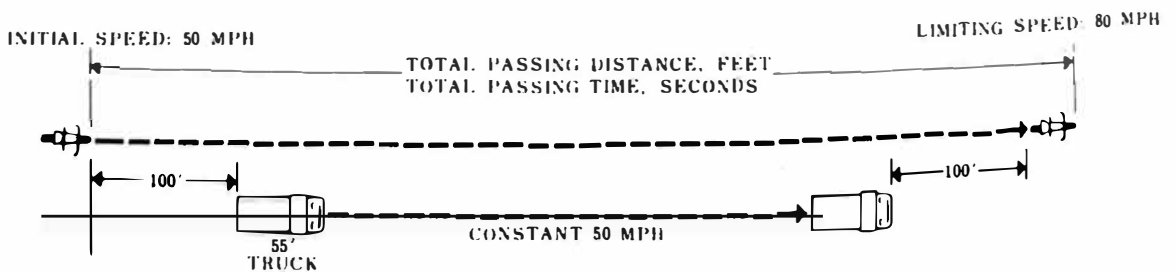

MEMO

MEMO

www.legends-yamaha-enduros.com



YAMAHA MOTOR CO., LTD.

PRINTED IN JAPAN