

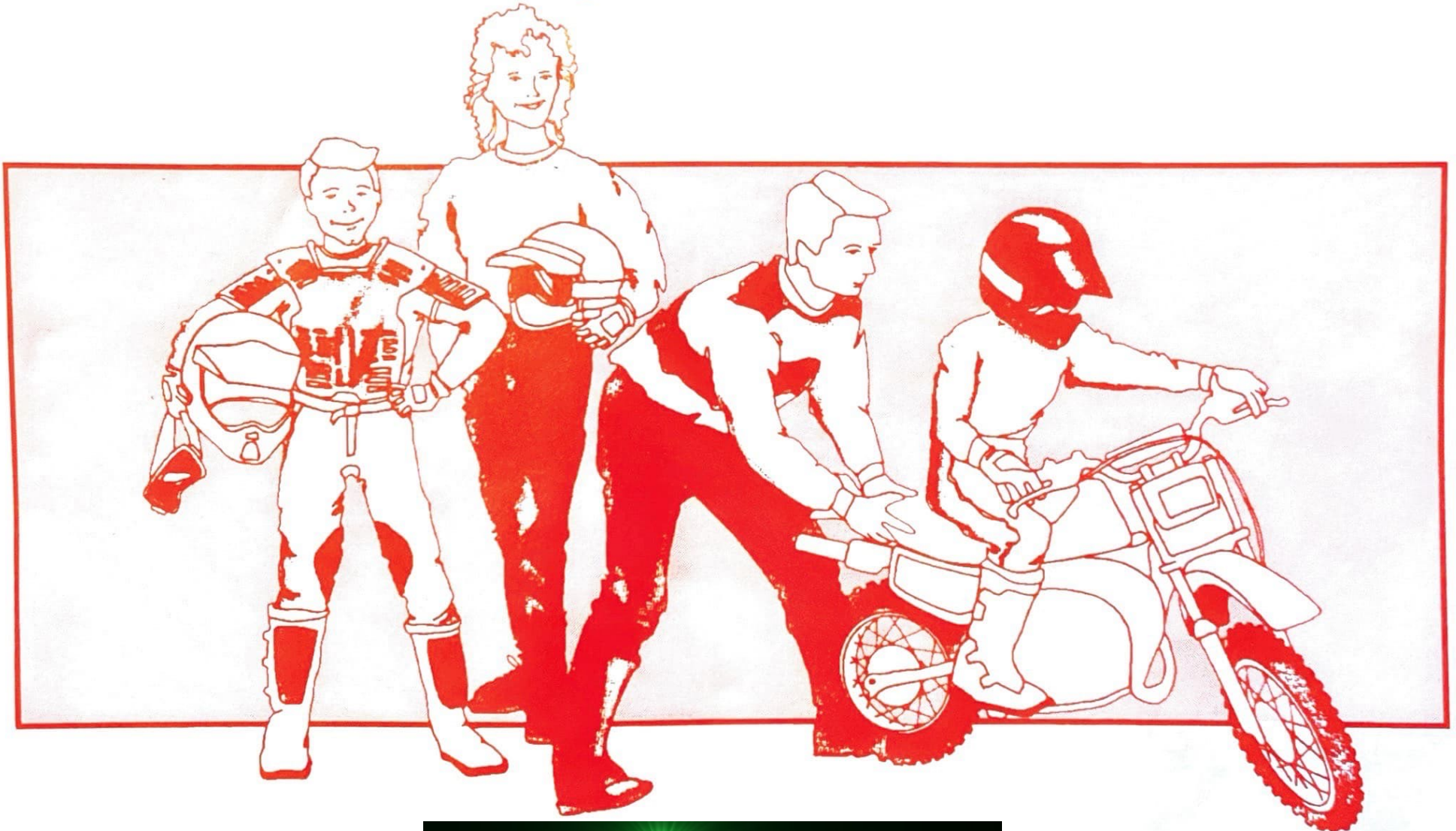

YAMAHA

PARENTS, YOUNGSTERS AND OFF-HIGHWAY MOTORCYCLES



LIT-11626-22-02

www.legends-yamaha-enduros.com

3PT-2819T-12

Parents, Youngsters and

Off-Highway

Motorcycles



MSF
MOTORCYCLE
SAFETY FOUNDATION[®]

The information contained in this publication is offered for the benefit of those who have an interest in riding off-highway motorcycles. The information has been compiled from publications, interviews and observations of individuals and organizations familiar with the use of off-highway motorcycles. Because there are many differences in product design, riding terrain and riding styles, there may be organizations and individuals who hold differing opinions. Consult your local motorcycle dealers or experienced off-highway motorcycle riders about appropriate riding locations in your area. Although the Motorcycle Safety Foundation will continue to publish responsible viewpoints on this subject, it must disclaim specific or general liability for the views expressed herein.

The Motorcycle Safety Foundation® (MSF) is a national not-for-profit organization promoting the safety of motorcyclists with programs in rider training, operator licensing and public information. The MSF is sponsored by BMW, BRP, Ducati, Harley-Davidson, Honda, Kawasaki, KTM, Piaggio, Suzuki, Triumph, Victory and Yamaha.

Motorcycle Safety Foundation
2 Jenner, Suite 150
Irvine, CA 92618-3806
949.727.3227
www.msf-usa.org

Copyright 2005

Revised April 2000

Parents...Be Cautious

Riding Off-Highway Motorcycles (OHMs) can be an enjoyable form of outdoor recreation when done properly. With preparation, practice, and parental supervision your youngster can safely develop and expand his or her riding skills. Remember off-highway motorcycles are not toys.

www.legends-yamaha-enduros.com

This manual is designed to assist you in the important task of teaching your youngster the safe and responsible use of an off-highway motorcycle. We urge you to read this booklet thoroughly. Also read other information provided with the motorcycle. The owner's manual contains important warnings and features of the motorcycle.

Deciding if your youngster is ready to ride an off-highway motorcycle is an important decision. The MSF strongly urges you to carefully determine your youngster's readiness to ride. There is a Readiness Checklist in Part 4 of this booklet. **Do not permit youngsters to ride an off-highway motorcycle if you doubt that they will operate the motorcycle safely.**

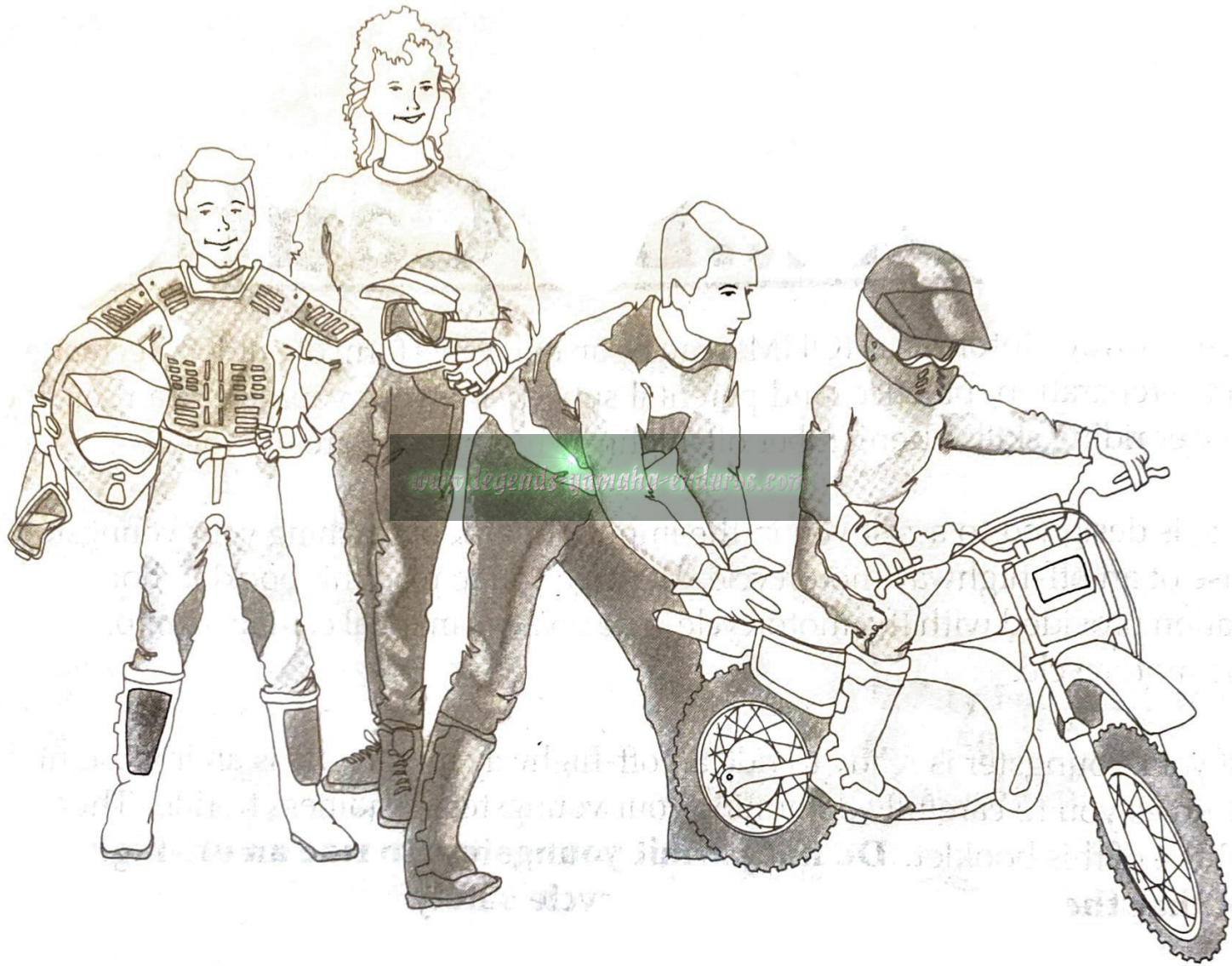

CONTENTS

INTRODUCTION

- Purpose of the Booklet 4
- Important Note to Parents 4
- Other Sources of Information 5

PART 1: Determining Your Youngster's Readiness to Ride an Off-Highway Motorcycle

- Readiness Guidelines 6
- Steps for Safe and Responsible OHM Riding 10

PART 2: Pre-Operating Procedures and Practice

- Protective Gear and Clothing 11
- Mounting/Dismounting 12
- Mastering the Controls 13
- Learning Activities 16

PART 3: Operating Procedures and Practice

- Learning Area/Riding Area 20
- Getting Used to the Vehicle in Motion 22
- Let's Start Riding 25

PART 4: Readiness Checklist

- Visual Perception/Motor/Development 29
- Physical Development 32
- Social/Emotional Development 34
- Reasoning and Decision-Making Ability 36

FINAL NOTE: To Parents 38

GLOSSARY 39

ANSWERS 41

INTRODUCTION

Purpose of the Booklet

Parents, *Youngsters and Off-Highway Motorcycles* is designed to assist you in determining if your youngster is ready to ride off-highway motorcycles (OHMs). It also provides you and your youngster with important safety information and tips on learning to ride. This booklet is divided into four parts: Part 1: Determining Your Youngster's Readiness to Ride an Off-highway Motorcycle; Part 2: Pre-operating Procedures; Part 3: Operating Procedures; Part 4: Readiness Checklist. There is information about protective gear, mounting, control operation and starting the engine. Operating procedures include starting, shifting, stopping and turning.

Important Note To Parents

Once your youngster is ready to learn to ride, YOU must be familiar with the motorcycle. You will be serving as teacher, coach, and safety supervisor for your youngster. You must know the controls, handling characteristics, maintenance requirements, and proper riding techniques. Read and understand the owner's manual and the labels provided with the vehicle. Review all instructions, requirements, and warnings with your youngster. Find out about state or local off-highway motorcycle requirements.

INTRODUCTION

Other Sources Of Information

In addition to the information provided in *Parents, Youngsters and Off-Highway Motorcycles*, there are other sources for obtaining safety information. The owner's manual provides specific maintenance and operating procedures for your motorcycle. It also includes warnings and cautions, as well as operating tips. Motorcycle dealers may have other literature and safety information. Another booklet, *Tips and Practice Guide for the Off-Highway Motorcyclist*, gives detailed riding procedures for the off-highway motorcyclist.

The MSF *DirtBike School*SM offers training on how to ride off-highway motorcycles. Available to youth as young as six years of age, as well as to adults. Call toll-free 877.288.7093 to enroll or for more information. To find out more on the internet, visit www.dirtbikeschool.com.

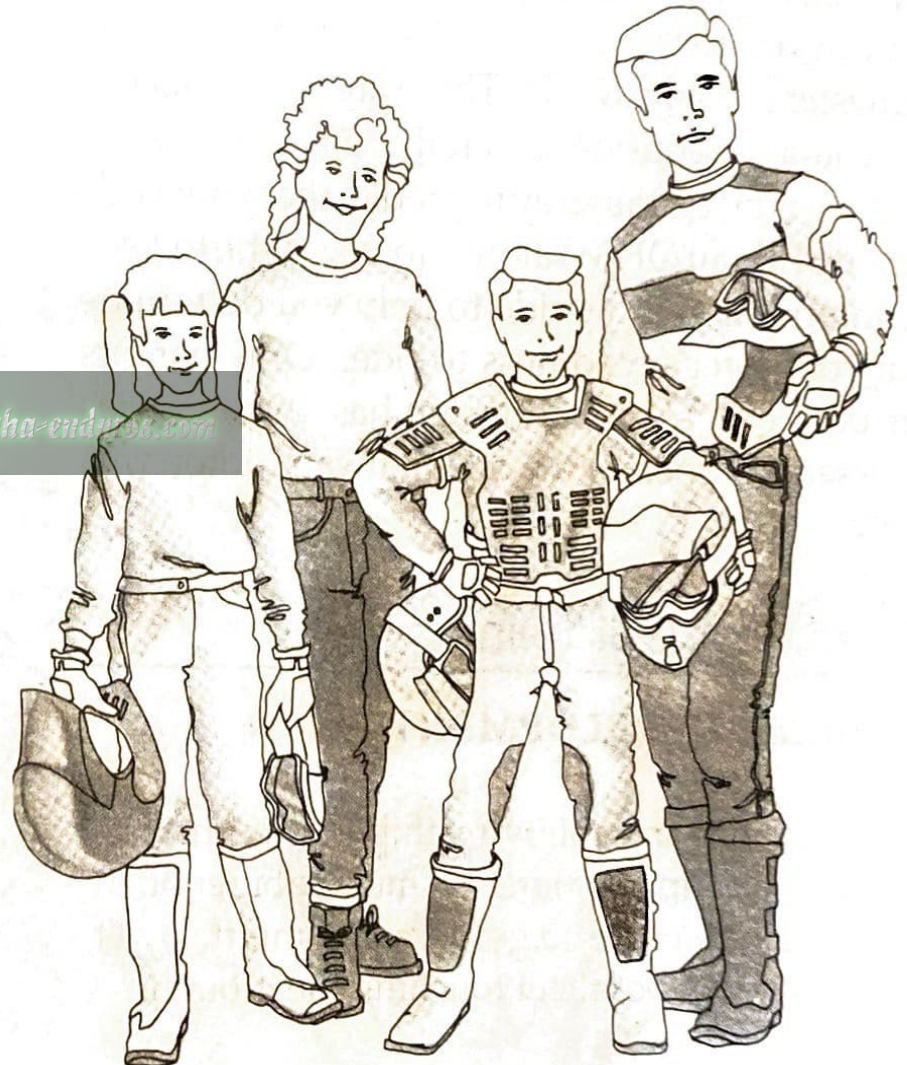

The first important decision you will have to make concerning your youngster and off-highway motorcycles (OHMs) is whether your youngster is ready to ride. There are several factors that you must consider carefully.

There is no certain way to predict that your child is able to ride an OHM safely. However, the following information is a guide to help you determine your youngster's readiness to ride. Only parents can decide if their youngster has the qualities necessary to operate an off-highway motorcycle safely.

Also make sure your youngster can comfortably reach and work all the controls. For example, can they turn the handlebars all the way to the right and left? Can they easily use their feet to work the brake pedal and gearshift lever? Can they operate the throttle and brake levers while they hold onto the handgrips? If not, the youngster is not physically ready to ride this OHM. Refer to the owner's manual to check for variations in the position of some of the controls.

Readiness Guidelines

PHYSICAL DEVELOPMENT

Physical size and ability are important considerations. For example, a youngster must be big enough to hold the motorcycle up, get on, and comfortably sit on the seat with both feet touching the ground.

PART 1

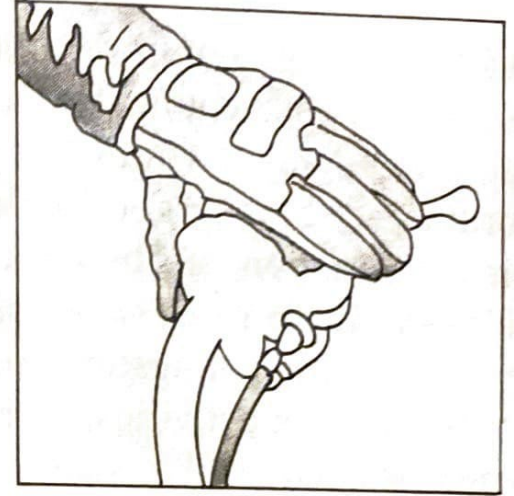
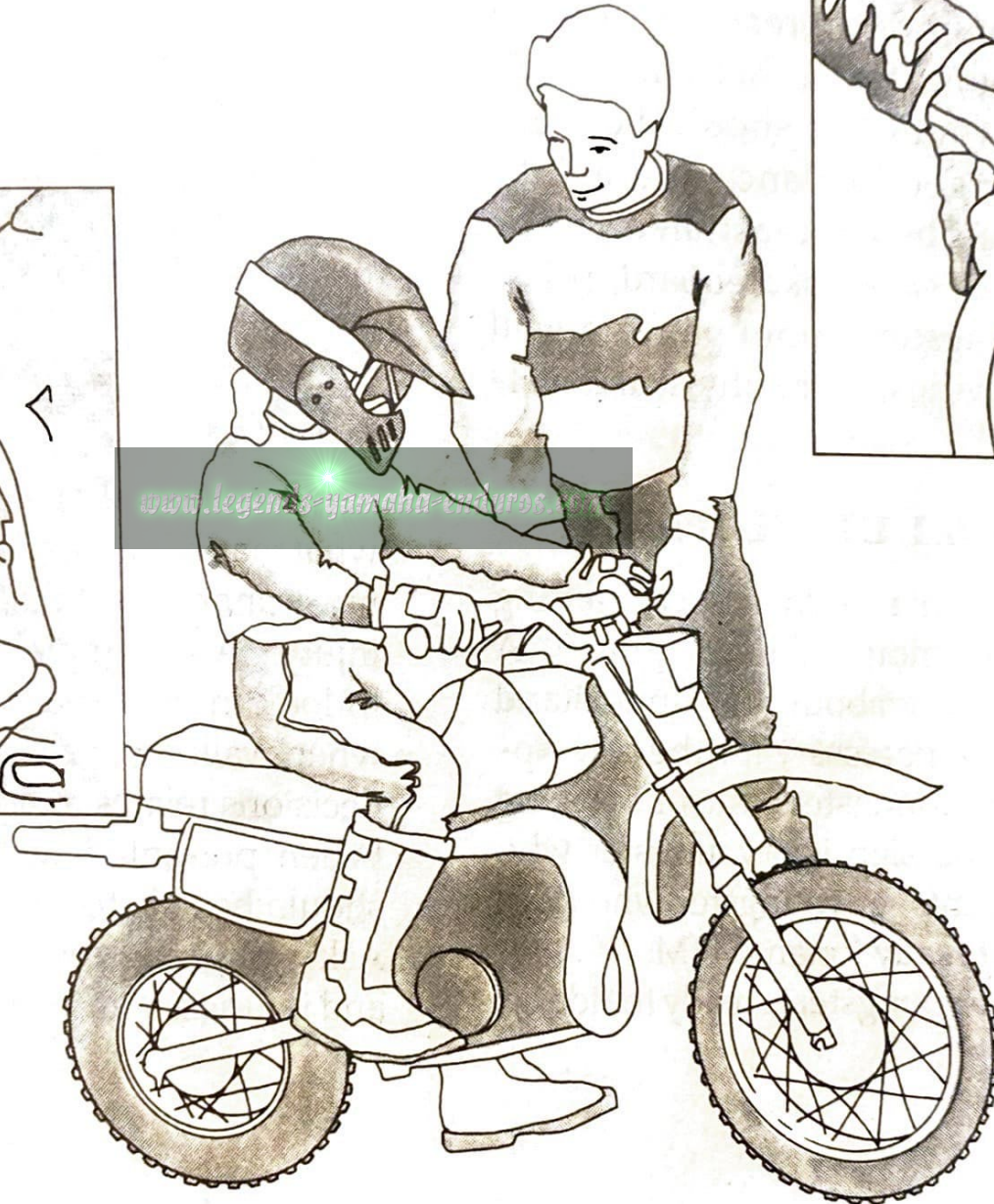

www.legenda-yamaha.com

PART 1

Additional signs of physical readiness can be observed in your youngster's other play activities. In general, a youngster should be well-coordinated, having good balance and agility. This coordination can be demonstrated by the abilities to jump rope, skate, skateboard, ride a bicycle, etc. If a youngster cannot perform well in these types of activities, more physical development is needed.

SOCIAL/EMOTIONAL DEVELOPMENT

How a youngster behaves in a social setting can be a sign of social/emotional development. A youngster needs to know about and understand rules. Certain rules are necessary for the safe operation of any vehicle. Youngsters must be willing to follow rules. A good sign is a youngster who obeys rules set by parents. A youngster who does not follow rules is not ready for an OHM.

One indicator that a youngster is ready to ride an

OHM is when they demonstrate a safety-conscious attitude and are aware of possible injury from reckless OHM operation. If the youngster has a habit of recklessness or is often involved in accidents while using bicycles or skateboards, the youngster is not ready to ride an OHM.

REASONING AND DECISION-MAKING ABILITY

Youngsters should have some knowledge about what may happen if something is done wrong. They must understand that unsafe actions can result in injury. An example of this is knowing the need to look in both directions before crossing a street when walking to school. The ability to make good decisions relates to a youngster's ability to reason. When presented with a problem, the youngster should be able to come up with a sensible answer. Ask your youngster to tell you what causes accidents and injuries. Your youngster needs to be able to tell

what causes accidents and how to avoid them. In general, a youngster should understand that he or she can get hurt as a result of making poor choices.

VISUAL PERCEPTIONS AND MOTOR DEVELOPMENT

This area involves how well a youngster sees and how vision is used with other physical movements. In other words, can a youngster see and react with the proper hand, foot, or body movement?

Several types of visual characteristics are important. The ability to see to the sides while looking straight ahead is called peripheral or side vision. You can determine a youngster's side vision by having him or her look straight ahead while you move objects to the side. The youngster should be able to see objects ninety degrees to the side while looking straight ahead. Rider awareness and safety improves with good side vision.

Being able to judge distance is another visual skill helpful when operating an OHM. Is your youngster able to tell how far one object is from another, or which of two objects is closer? OHM riding requires a person to judge distance and react properly.

Being good at playing video games, hitting a baseball, etc., is a good sign that a youngster's eye and hand movements are fairly well coordinated.

In summary, you must consider many things before you decide to put your youngster on an OHM. There is no exact formula to use in making this decision. The Readiness Checklist, Part 4, can assist you with some points to evaluate. If you are not able to check most of the statements, your youngster is probably not ready to ride an OHM.

PART 1

Steps For Safe And Responsible OHM Riding

Once you determine that OHM use is proper for your youngster, it is time to prepare yourself as a good OHM teacher and supervisor.

STEP ONE: Educate Yourself about OHM Safety and Proper Riding Techniques

You must learn as much as possible about off-highway motorcycles in general, and especially your youngster's motorcycle. You must be qualified to instruct and supervise your youngster. This means that you will need to understand the features of the motorcycle and proper riding techniques. The best source of information is the owner's manual supplied with the motorcycle. Read the owner's manual before you begin to instruct your youngster about OHM safety. Pay particular attention to the warning labels and stickers on the motorcycle.

STEP TWO: Teach Your Youngster Safe and Proper Riding Techniques

Teaching your youngster off-highway motorcycling is a step-by-step process. It begins with safety rules and moves to actual riding techniques. Since youngsters learn at different rates, it will be up to you to set the pace of your youngster's progress. At some point you may decide that he or she is not ready to ride an OHM.

STEP THREE: Avoid Unsafe Situations Through Close Supervision

ALWAYS closely supervise your youngster's riding. This is true even if your youngster has learned and mastered the rules and skills of safe OHM riding. Youngsters can get tired easily and become careless. They do not always see everything that is important around them. Your close supervision and good judgment are important.

Protective Gear And Clothing

The nature of off-highway riding demands that your youngster wear proper protective gear. Motorcycle riders should ALWAYS wear a helmet, eye protection, gloves, long pants, a long-sleeved shirt or jacket, and over-the-ankle boots. Anything less is not adequate protection. NEVER let anyone ride an off-highway motorcycle without a Department of Transportation (DOT) compliant motorcycle helmet. Be sure the fit is correct. It should be snug but not tight. It must be properly fastened.

Protective gear is necessary in any weather, even when the temperature is warm. In cooler weather you should dress your youngster with additional layers of clothing. Some riders choose to wear a kidney belt and chest or back protector for additional protection. On the right is a drawing of well-equipped riders. Show this drawing to your youngster and point out what is important.

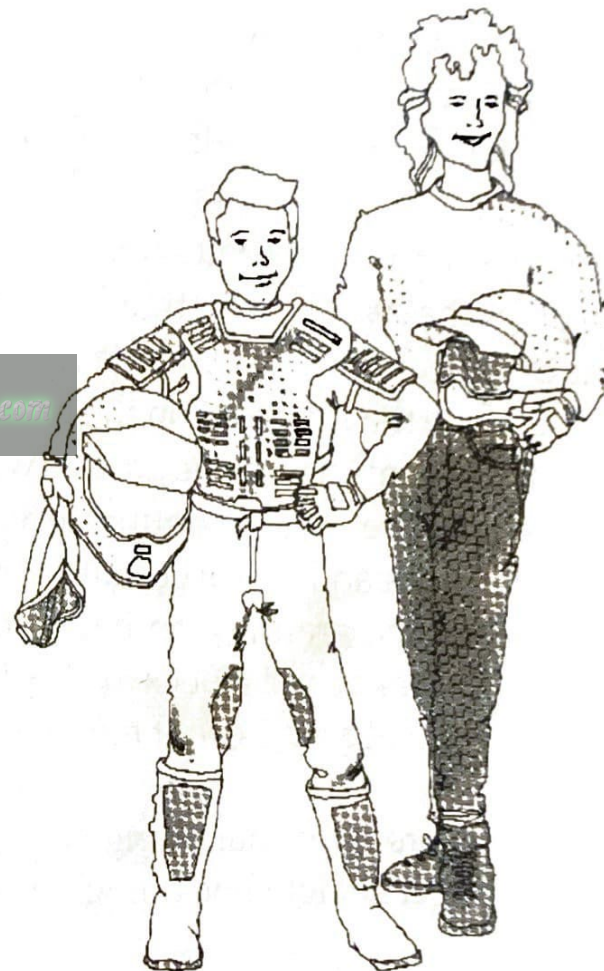

PART 2

Mounting/Dismounting

Have your youngster wear safety gear whenever getting on a motorcycle. This action will stress the importance of safety gear and help develop safe riding habits.

Mounting is typically from the left side. To mount from the left, point the handlebars straight. While squeezing the front brake lever, swing the right leg over the seat and place the right foot on the ground. Both feet should be in contact with the ground while sitting on the motorcycle. Dismounting reverses the procedure: the kickstand is placed fully down. With the left foot on the ground, the handlebars straight and the front brake lever squeezed, the right leg is swung over the seat and the foot touches the ground.

Correct riding posture helps your youngster operate the controls. Proper straight line riding posture includes:

- Head and eyes up, looking well ahead.

- Shoulders relaxed, back straight.
- Elbows bent, slightly out and away from the body.
- Hands on the handlebars.
- Knees in toward the tank.
- Feet on the footpegs, toes pointing straight ahead.

The hand and foot controls are important to riding safely. While riding, both hands should be kept on the handlebars and both feet on the footpegs of the motorcycle. Removing a hand or foot can reduce the ability to control the motorcycle.

An off-highway motorcycle rider will need to shift body weight in certain situations. This is especially true in maneuvers such as turning, negotiating hills, and riding on bumpy terrain. Your youngster should be able to operate the controls during these maneuvers. Now is a good time to make sure your youngster can reach the controls from different body positions. Have the young-

ster remount. Turn the handlebars full left and full right. See that this can be done easily. Next have the youngster slide up and back on the seat. Mention that body movement is important. Body movement and shifting weight help to control the motorcycle.

Mastering The Controls

(Go through these control exercises with the motorcycle's engine OFF.)

Show your youngster how to use each control as you describe its action. Refer to the owner's manual to learn control location and function before instructing your youngster. Test yourself by operating the controls. Have your youngster dress in the proper protective gear and sit on the machine as you point out each control. It is important to have your youngster wear all the protective gear whenever sitting on an off-highway motorcycle.



PART 2

BRAKES

Most small off-highway motorcycles have a hand lever on the right handlebar which operates the front brake. Most also have a foot pedal on the right side to operate the rear brake. Refer to the owner's manual for correct brake location and operation.

Explain and demonstrate proper braking procedure. Be sure your youngster can apply the brake(s) properly while seated and without looking down. Smooth operation should be encouraged.

THROTTLE CONTROL

Explain to your youngster that twisting the throttle control back will make the motorcycle go faster. Closing the throttle control slows the motorcycle.

Youngsters need practice using the throttle control smoothly. They tend to use it like an on/off switch. With the engine off, have your youngster

move the throttle to various positions. Practice turning the handlebars and using the throttle at the same time.

ENGINE STOP SWITCH

Explain to your youngster how to use the engine stop switch to turn off the engine. With the engine off, show how the stop switch works. Later, your youngster can practice using the stop switch when the engine is actually running.

CLUTCH/SHIFT LEVER

Some small OHMs do not have a clutch lever; some don't have a shift lever either. This section applies only to motorcycles with a shift lever. Those that do have a shift lever may have different shift patterns. Refer to your owner's manual for proper shifting instructions. It is important to learn how the shift lever works.

Explain that it is possible to shift the motorcycle with the shift lever in order to ride at different

speeds. Have your youngster practice shifting with the engine off. The shift lever, clutch lever (if equipped), and throttle control work together to move the motorcycle. When shifting to first gear from neutral; the throttle is closed, the clutch lever is squeezed, and the front brake is applied before moving the shift lever into first gear. When starting out, the front brake is released. The throttle is gradually opened while the clutch is slowly released. If the clutch is released too quickly, or too much throttle is applied, the motorcycle may lunge forward causing loss of control. With the engine off, have your youngster practice upshifts, downshifts, and locating neutral.

SPEED LIMITERS

(supervisor control feature)

Some models come equipped with a removable exhaust restrictor, or another feature which reduces maximum speed. Refer to your owner's manual and talk to your dealer about this.

PART 2

Learning Activities

Here are some activities that your youngster can use to help learn about motorcycle parts and controls

CROSSWORD PUZZLE

Here is a crossword puzzle for your youngster to complete.

Across

1. What this booklet is all about.
2. A piece of safety equipment for your head that you must never forget to wear.
3. Protective gear for the hands.
(a synonym)
5. Hand lever you use when shifting gears.

Down

6. The place on which you keep your feet when riding.
7. Protective gear for the feet and ankles.

All the words needed are listed below:

CLUTCH	BOOTS
FOOTPEGS	HELMET
GLOVES	OFF - ROAD
SAFETY	

Answer Guide on Page 41

NAME THE MOTORCYCLE PARTS (Typical)

Have your youngster write the number of the motorcycle part or control on the correct line for the diagrams shown. (Answer Guide on Page 42)

1. Clutch lever
2. Hand brake lever
3. Foot brake lever or pedal
4. Throttle

5. Choke or enrichening device
6. Engine stop switch
7. Gas cap/tank vent

8. Starter (kick)
9. Electric starter (if equipped)

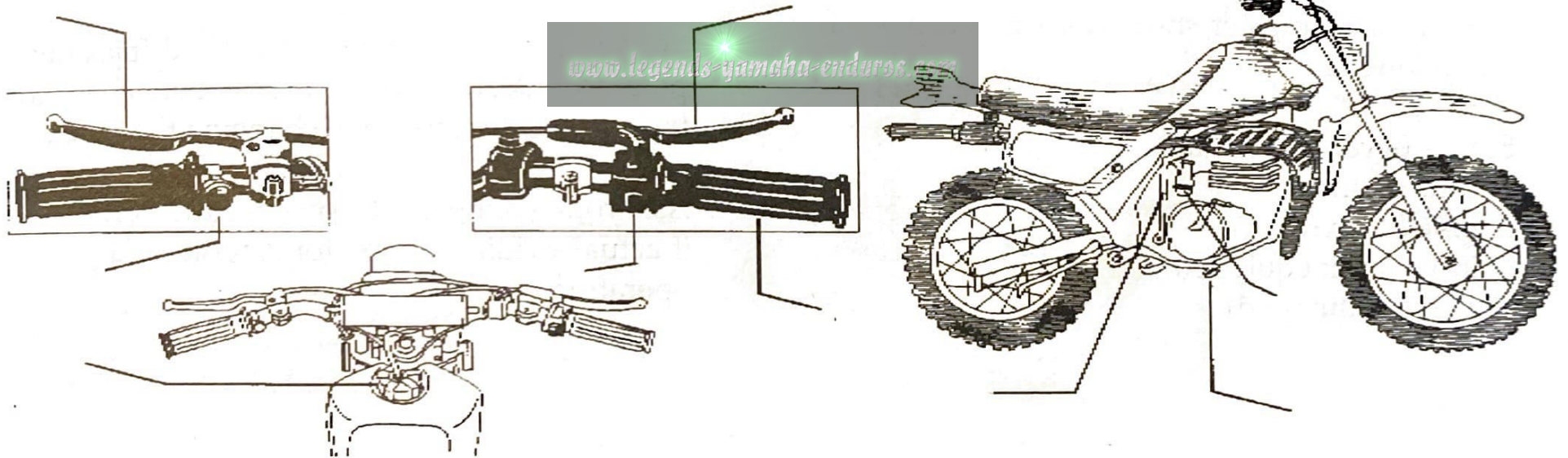

PART 2

LOCATING THE CONTROLS GAME

Now that you have shown your youngster the controls, it is your youngster's turn to show you. The engine remains OFF for this exercise and your youngster will be on the motorcycle. The youngster should be wearing the proper protective gear to develop this safety habit.

1. Have your youngster show you the location of the following:

Brakes (lever and pedal)
Throttle Control
Engine Stop Switch
Shift Lever (if equipped)
Clutch (if equipped)

2. Have your youngster show you how the controls work. Be sure he or she understands the proper operation of each control. Skilled use of these controls should develop with practice. Under actual riding conditions the rider will have to watch ahead while operating the controls. Your youngster should be able to find the controls quickly without looking for them.
3. With your youngster looking ahead (pick out a point to look at), have him or her operate the controls. Repeat often while changing the order.
4. Ask your youngster to operate the controls as if actually riding. Look for smooth and precise operation.

PRE-RIDE CHECK

Before you continue:

1. Have you determined your youngster's readiness to ride an OHM? Do not let your youngster ride if you have any doubt. (Refer to the Readiness Checklist, Part 4)
2. Have you read the owner's manual and reviewed it with your youngster?
3. Does your youngster fit the motorcycle properly?
4. Have you inspected the vehicle and maintained it according to the owner's manual?
5. Is your youngster wearing the proper protective gear? Is the mounting procedure correct?
6. Has your youngster learned to locate the motorcycle controls without looking at them? Does he or she know how to operate them smoothly?
7. Does your youngster understand that he or she must always ride off-road?
8. Have you stressed to your youngster to keep his or her feet on the footpegs while riding?

If you have completely covered all these areas, you are ready to go on to Part 3.

Carefully observe your youngster's first use of the motorcycle. Observe his or her readiness to ride. Only permit your youngster to continue to ride if they have the size, strength, and attitude needed to ride safely.

Show your youngster the engine, exhaust pipe, and muffler. Tell him or her not to touch these parts because they are hot while the engine is running. Explain that they will remain hot after the engine is stopped. Also explain that hands and feet must be kept away from moving parts of the motorcycle.

Your youngster's safety depends in part on the mechanical condition of the motorcycle. Be sure to inspect it thoroughly before each use. Starting and refueling of the vehicle should be done by responsible adults only. Follow a regular maintenance program. See the owner's manual for inspection details.

Even after young riders have learned the basic riding skills, direct supervision by an experienced adult is necessary AT ALL TIMES. Make sure

that all off-highway motorcycle users under your supervision get proper riding instructions. Stress that an OHM is not a toy. Follow safety precautions strictly to provide a "safety first" approach to off-highway motorcycle riding. Teaching your youngster how to ride an OHM safely will increase the enjoyment of off-highway motorcycle riding.

Learning Area/Riding Area

The best place for learning is a level area 100' x 200' that is free from obstacles such as rocks, stumps, or holes. The learning area may have a loose or hard dirt surface. A grassy surface is also acceptable. It should not have two different surfaces. **Under no circumstances should the surface be concrete or asphalt.** Be sure there is room enough to maneuver, and that no other riders are close.

PART 3

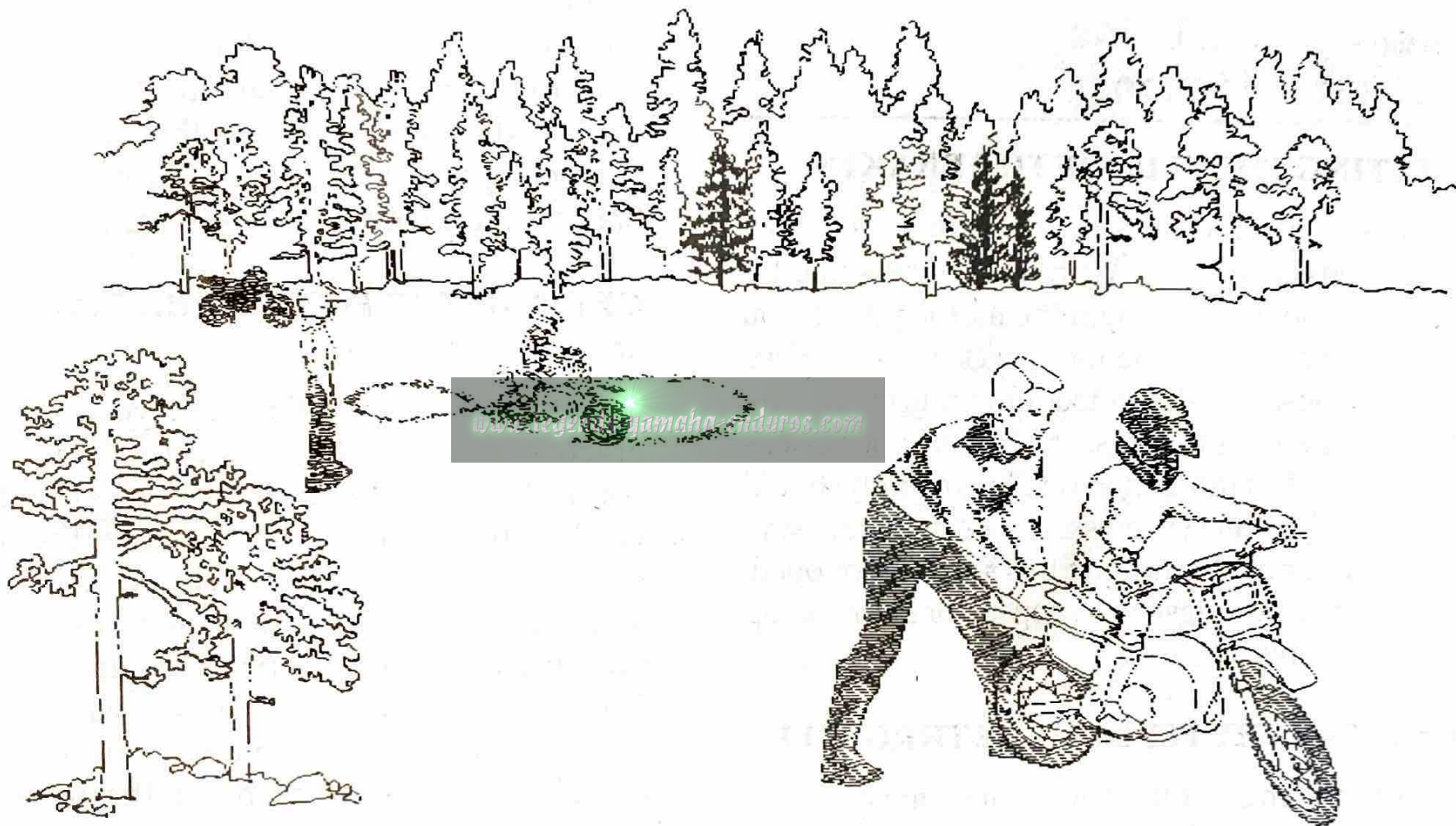

PART 3

Getting Used To The Vehicle In Motion

GETTING THE FEEL OF THE BRAKES

Be sure your youngster is wearing all of the proper protective gear. With the engine still OFF, have your youngster mount the motorcycle. If you physically can, push the motorcycle slowly. Have your youngster brake to feel how much pressure is needed for a smooth stop. If your youngster's motorcycle has more than one brake, both should be applied with even pressure. Practice this several times until you are sure this skill is developed. Remind your youngster to keep his or her head up and look forward.

GETTING THE FEEL OF THE THROTTLE

With the engine OFF, have your youngster practice smooth throttle control. Your youngster will learn how much throttle it takes to start moving in

a later exercise. Explain that opening the throttle will increase speed and that closing the throttle will decrease speed. Releasing the throttle and applying the brakes will slow the motorcycle. Ask your youngster to tell you how throttle control and braking affect the motorcycle's speed.

GETTING THE FEEL OF THE CLUTCH

(if equipped)

With the engine OFF, have your youngster practice smooth clutch control. Have your youngster shift the motorcycle into first gear. While you push the motorcycle have the youngster slowly release the clutch lever. The point which the motorcycle stops moving indicates the clutch engagement point or "friction zone." The "friction zone" is the point at which engine power begins to be transmitted to the rear wheel. Explain that this is the point the motorcycle will start moving when the engine is running. Smooth operation will prevent stalling and

allow smooth shifting. Remind the youngster that the throttle should be closed when shifting gears. Practice this exercise several times until the skill is developed.

GETTING THE FEEL OF TURNING

With the vehicle stopped and the engine OFF, have your youngster practice the proper turning technique:

1. For a right turn, look to the right and lean the motorcycle to the right.
2. For a left turn, look to the left and lean the motorcycle to the left.

Repeat this exercise with the kickstand up as you push the motorcycle. Make sure he or she can turn the vehicle in both directions using this technique while you maintain balance of the motorcycle.



PART 3

BEING PREPARED FOR RIDING PRACTICE

Be sure to observe all the safety precautions covered in the Introduction and Parts 1 and 2. Double check that the riding area is free from hazards. Your youngster should wear all the proper protective gear, and the speed limiter (if equipped) should be installed and working correctly.

STARTING THE MOTORCYCLE

Always start the motorcycle for your youngster. To remember the proper starting technique use "FINE-C."

Double check for neutral. Start the engine. Have your youngster carefully mount. Let your youngster operate the engine stop switch and shut off the motor. Re-start the engine and repeat. Allow the engine to warm up until it runs smoothly with the choke off.

F	FUEL VALVE	Put to "on" position.
I	IGNITION	Ignition on.
N	NEUTRAL	Motorcycle in neutral (the motorcycle rolls with the clutch lever released).
E	ENGINE	Stop switch in run/on start position.
C	CHOKE	On (for cold engine only).

Let's Start Riding

Walk next to the motorcycle when your youngster first starts riding. You can also let the beginner ride back and forth between you and another adult. Help your youngster with the turns as he or she practices throttle control and braking.

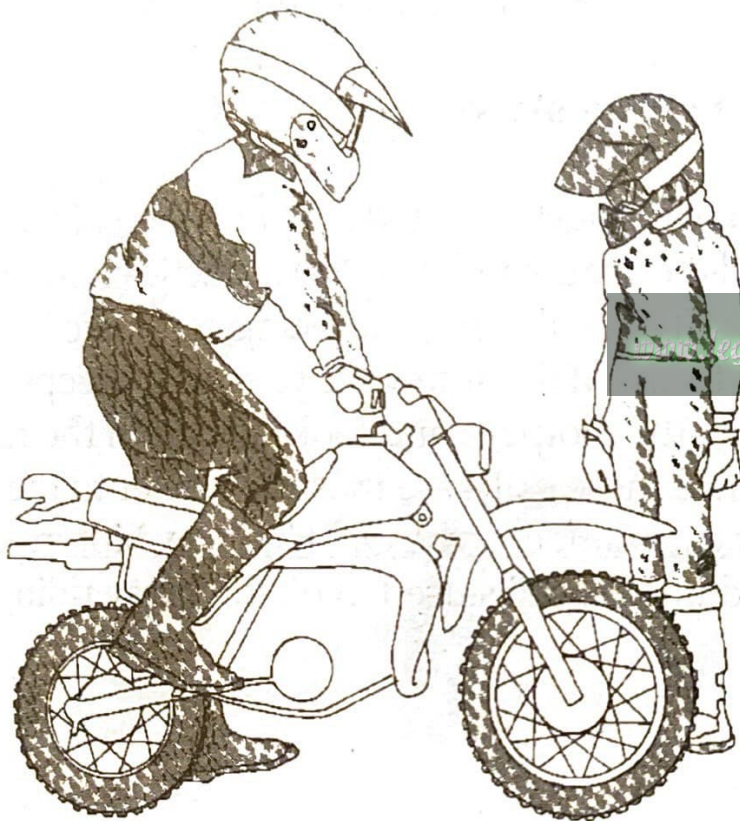

Start the motorcycle for your youngster

STARTING OUT AND STOPPING

Before your youngster moves the motorcycle under power, take a few moments to practice smooth clutch control. After shifting to first gear, have your youngster rock the motorcycle a few inches back and forth by moving the clutch in and out of the "friction zone." The clutch is not fully released while doing this. It is important that clutch operation is smooth before riding in the practice area.

The next practice session is straight-line starts and stops. Keep the riding under control. However, riding too slowly will make balance

PART 3

more difficult. Both brakes should be used together for smooth stops. The left foot should be placed on the ground first, keeping the right foot on the rear brake.

Be sure your youngster develops a good feel for the use of the throttle and controls. After the youngster has mastered starting and stopping at slower speeds, increase speeds by shifting.

TURNING

Remind your youngster of the two steps for turning:

1. For a right turn, look to the right and lean the motorcycle to the right.
2. For a left turn, look to the left and lean the motorcycle to the left.

Have your youngster practice turning in both directions at slow speeds. Allow enough room to make a wide turn. After your youngster is skilled in making wide turns, try tighter turns.

Keep speed slow.

Your youngster should master these skills at low speeds before going faster. Next, practice some figure eights. This will help your youngster make left and right turns. Make sure your youngster keeps both feet on the footpegs and looks ahead in the turns.

Once these skills are mastered, refer to the Tips & Practice Guide for the Off-Highway Motorcyclist for additional skills used in off-highway riding.



www.legends-yamaha-enduro.com



This Readiness Checklist is provided to help you determine your youngster's readiness to learn to safely operate and control an OHM. There is a significant amount of judgment needed in determining a youngster's readiness to ride an OHM. The ultimate decision is the responsibility of the parent, guardian, or supervising adult. It is important that parents make informed decisions about whether or not their youngster becomes involved in off-highway motorcycle activity.

There are four developmental areas considered in the Readiness Checklist. These include: visual perception/motor development, physical development, social/emotional development, and reasoning and decision-making ability. Several questions

are listed to help you determine if your youngster possesses the skills and capabilities to safely learn to operate an OHM.

The best way to utilize the Readiness Checklist is to read the particular ability, consider the answers to the questions for that ability, and check those abilities that you determine are present in your youngster. There are no suggestions as to how many abilities or the degree of ability that your youngster should possess. This Readiness Checklist may help you consider the appropriateness of OHM operation for your child. The ultimate decision for your youngster's involvement with off-highway motorcycles belongs to you, the parent.

VISUAL PERCEPTION/MOTOR DEVELOPMENT

Ability

1. Youngster can see with sufficient clarity.



Points to Evaluate

Can youngster see letters and numbers at least as well as you?

Can youngster distinguish colors?

Has youngster demonstrated adequate vision in other activities (riding bicycles, running, sports, or other recreational activities)?

www.legends-yamaha-enduros.com

2. Youngster possesses ability to perceive depth or distance.

When looking at two objects in the distance, can youngster tell which is farther or closer?

3. Youngster has adequate side vision/peripheral vision.

Can youngster see objects 90 degrees to each side while looking straight ahead?

4. Youngster can judge the speed of objects.

Does the youngster judge the speed of objects (fast, medium, slow) that agree with your judgments? (For example, a car on the highway, a train moving past a crossing, a dog running, people walking.)

PART 4

Ability

5. Youngster can state the distances of objects in terms of feet, yard, miles.
6. Youngster can follow movement of objects.
7. Youngster can visualize distances as displayed by a picture or photograph.
8. Youngster can follow a moving object while accomplishing hand manipulation.
9. Youngster can describe cause-and-effect experiences.

✓ Points to Evaluate

- Can youngster tell how many feet or yards it is from the house to the road?
- Can youngster tell how wide a hallway is, or the width of a room?
- Can youngster follow the path of such things as: a hit or thrown baseball, a moving car, objects in a video game?
- Can youngster estimate distance between objects in a family photograph?
- Can youngster estimate distance between objects when looking at a landscape picture?
- Can youngster dribble a basketball without looking at it?
- Can youngster manipulate video game controls while following objects on a screen?
- Can youngster describe a minor injury he or she received and correctly describe the causes?
- Can youngster describe settings or situations that can produce injury if precautions are not taken?

Ability

✓ Points to Evaluate

10. Youngster can concentrate on more than one element at a time in solving a puzzle or problem.
- Can youngster describe what may cause injury when doing such things as running, swimming, bicycling, riding in a car?
 - Can youngster pick out or describe several items within a picture?
 - Can youngster assemble a puzzle without unusual problems or delays?
 - Can youngster describe what to do if a house fire should occur?
11. Youngster can maintain relative spans of attention when given a variety of stimuli.
- Can youngster complete school homework assignments without being easily distracted?
 - Can youngster assemble more difficult puzzles; for example, a nature scene or picture?

PART 4

PHYSICAL DEVELOPMENT

Ability

1. Youngster can sit comfortably on the motorcycle and reach the controls easily.



Points to Evaluate

Can youngster place his or her feet firmly on the footpegs?

Do the youngster's fingers reach comfortably around the handlebars and control levers? How about with the handlebars turned? How about in different seating positions?

Can youngster stand (with knees slightly bent) and have a few inches of space from the seat?

Can youngster easily reach the foot controls?

Can youngster dress with proper protective gear including putting on helmet and fastening the chin strap?

2. Youngster has sufficient strength and familiarity to operate the controls with ease.

While sitting on the vehicle, can youngster:

Squeeze the hand controls?

Operate the shift lever (if equipped)?

Operate the choke and fuel valve with ease?

Press the brake lever with sufficient pressure?

Operate the controls without looking at them?

Ability

3. Youngster is sufficiently coordinated.



Points to Evaluate

Can youngster walk a "balance beam" (2" x 4" x 8') flat on floor?

Can youngster ride a bicycle, rollerskate or skateboard safely?

Can youngster walk on tiptoes for 10 feet?

Can youngster jump rope?

Can youngster catch a ball with hands rather than with arms?

4. Youngster has sufficient endurance to maintain strength over a period of time.

www.legends-yamaha-enduros.com

Can youngster play outdoor games without fatigue?

Can youngster participate in indoor games and sports without tiring before other youngsters?

PART 4

SOCIAL/EMOTIONAL DEVELOPMENT

Ability

1. Youngster can understand and follow rules.



Points to Evaluate

Does youngster follow rules established at home?

Do teachers say that the youngster follows rules?

Does youngster listen and respond to adult supervision?

Does youngster comprehend the importance and seriousness of having rules and regulations?

2. Youngster generally will obey parents and supervisors.

Does youngster avoid challenging authority or rebelling when rules are imposed?

3. Youngster controls behavior according to expectations?

Does youngster show evidence of self-control...doesn't get easily frustrated or upset?

Does youngster understand consequences associated with certain actions (like not wearing a safety belt in the car)?

Does youngster think about results before performing some action (like crossing the street, hitting or throwing a ball)?

Ability

4. Youngster understands other youngsters may be permitted to do what he/she may not be allowed to.



Points to Evaluate

Does youngster recognize unsafe actions of other youngsters?

Does youngster appreciate being safer than others?

Does youngster accept rules that are more stringent than what other youngsters have to follow?

5. Youngster can give reasons and/or solutions to problems seen in the environment.

Can youngster explain how land (or grass) gets worn?

www.legends-youth-arts.com

Can youngster explain how even small damage to land can take years to recover?

Can youngster distinguish between untouched land and used land?

6. Youngster can make decisions based on reality and not fantasy.

Can youngster complete a task in a step-by-step fashion (assemble a toy, clean a room)?

Does youngster comprehend real injury as opposed to "cartoon" injury?

Does youngster respond with logical solutions when asked to solve a problem?

PART 4

REASONING AND DECISION-MAKING ABILITY

Ability

1. Youngster comprehends that interaction with others and things can result in injury.
2. Youngster has a basic understanding of what being careful means.

✓ Points to Evaluate

- Can youngster describe how and why a person received physical injury or pain?
- Does youngster notice impending accidents or potential injury-producing events, such as in sports activities or bicycle riding?
- Can youngster explain why it takes distance to stop?
- Can youngster explain how moving at even low speed can result in injury if stopped suddenly or by hitting something?
- Does youngster know why rules are established?
- Does youngster notice or recognize others being careful in action-oriented activities?
- Does youngster notice professional athletes use protective gear as part of their sport?

Ability

3. Youngster understands that rules are made to reduce injury and provide long-term enjoyment.
4. Youngster has basic understanding of the physical limitations of stopping and turning.



Points to Evaluate

- Can youngster explain the reason for rules at home or school?
- Does youngster understand the value of prevention? Of wearing protective gear?
- Can youngster recognize that not following rules can eliminate future fun and enjoyment?
- Can youngster explain what may happen if moving too fast while going around a curve on a bicycle? On a skateboard? On an off-highway motorcycle?

www.legends-yamaha-enduro.com

FINAL NOTE

TO PARENTS

We hope this booklet has helped you and your youngster take a “safety first” approach to off-highway motorcycle riding. All off-highway motorcycle riders must use good judgment and be responsible. It is up to YOU to set a good example about motorcycle safety. You must help your youngster ride sensibly and safely at all times.

After your youngster has mastered the riding skills in this booklet and has matured to a higher level of skills, he or she may be ready to practice more advanced riding. The Motorcycle Safety Foundation’s *Tips & Practice Guide for the Off-Highway Motorcyclist* booklet provides information about riding on hills, riding across slopes, and other more advanced skills. Youngsters should have a good understanding of riding skills before using unfamiliar areas. They

should ride on flat areas, gentle hills, and gradual slopes. Be sure that your youngster rides slowly over unfamiliar terrain to locate and avoid bumps, holes, and other possible hazards. You should check the area first.

The Motorcycle Safety Foundation also recommends a video program, *The MSF DirtBike School: Learn to Ride Safely*. It demonstrates and discusses responsible riding practices.

It is also recommended that you and your youngster read the information in the owner’s manual. To find out more about rider education and off-highway motorcycle safety programs offered, or to order the video or publications, contact the **Motorcycle Safety Foundation at 2 Jenner, Suite 150, Irvine CA 92618-3806, 949.727.3227 or visit www.dirtbikeschool.com**

BRAKES - The parts of a motorcycle which allow the operator to slow down or stop the machine.

BRAKE LEVER - The hand brake located on the handlebar.

BRAKE PEDAL - The foot brake which is operated by the right foot.

CABLES - Heavy insulated wires. There are two kinds: mechanical and electrical. Brake cables are mechanical. The headlamp cable is electrical.

CARBURETOR - Device which provides the engine the proper mixture of fuel and air.

CHOKE - A device which enriches the mixture of gasoline and air supplied to the engine for cold engine starting.

CLUTCH LEVER - The hand lever used to disengage the clutch when changing gears.

DRIVE CHAIN - The chain which connects the engine to the rear axle to give a motorcycle motion.

ENGINE STOP SWITCH - Switch used to stop the engine without removing the hands from the handlebars.

EXHAUST - Leftover gases from the combustion process that come out of the tailpipe when the motorcycle engine is running. Exhaust contains deadly carbon monoxide gases.

EYE PROTECTION - Goggles or a shatter resistant shield worn over the eyes while riding to protect against dust, flying insects, or other debris. Such eye protection, when tinted, may be effective against bright sun or snow-glare conditions.

FINE-C - A pre-start routine. A way to remember the pre-start routine:

F - Fuel valve on

I - Ignition on

N - Neutral

E - Engine stop switch in run position

C - Choke

FOOTPEGS - Pivoting pegs on which a motorcycle operator should keep his/her feet while riding.

FUEL VALVE - A valve, usually hand operated, with an on, off and "reserve" position. Controls gasoline flow to the carburetor.

GLOSSARY

HANDLEBAR - The metal bar attached to the front end of the motorcycle that turns the front wheel for steering. Many of the controls for the motorcycle are located on the handlebar.

HELMET - The most important protective clothing to be worn when operating a motorcycle. It covers the head and helps protect against skull fracture or brain injury in an accident.

OFF-HIGHWAY or OFF-ROAD VEHICLE - Any vehicle, including off-highway motorcycles and ATVs, which is restricted by law from operating on public roads.

OHM - Off-Highway Motorcycle

PSI - Refers to air pressure in the tires and stands for "Pounds per Square Inch."

READING THE TERRAIN - Looking well ahead while riding, anticipating hazards.

SHIFT LEVER - On those motorcycles equipped with a shift lever, it allows the operator to change gears. The shift lever is operated by the left foot.

TAILPIPE - That part of the exhaust system which expels waste gases.

THROTTLE - The control operated by the right hand which controls the engine speed.

TRACTION - Tread friction between the ground and the tires.

TRANSMISSION - Mechanism used to transmit power from the engine to the wheels.

CROSSWORD PUZZLE

ANSWERS

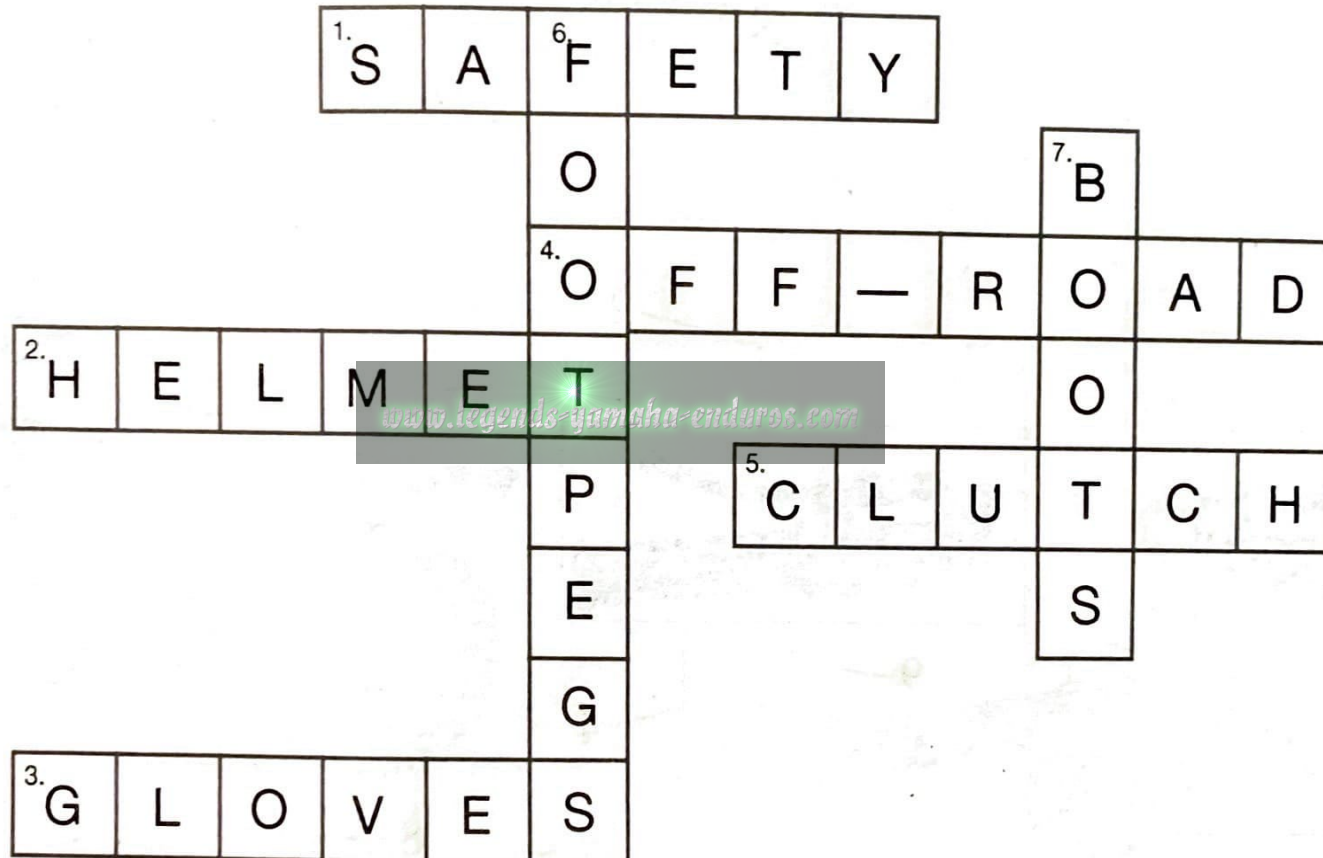

ANSWERS

NAME THE MOTORCYCLE PARTS (Typical)

1. Clutch lever
2. Hand brake lever
3. Foot brake lever or pedal
4. Throttle
5. Choke or enrichening device
6. Engine stop switch
7. Gas cap/tank vent
8. Starter (kick)
9. Electric starter (if equipped)

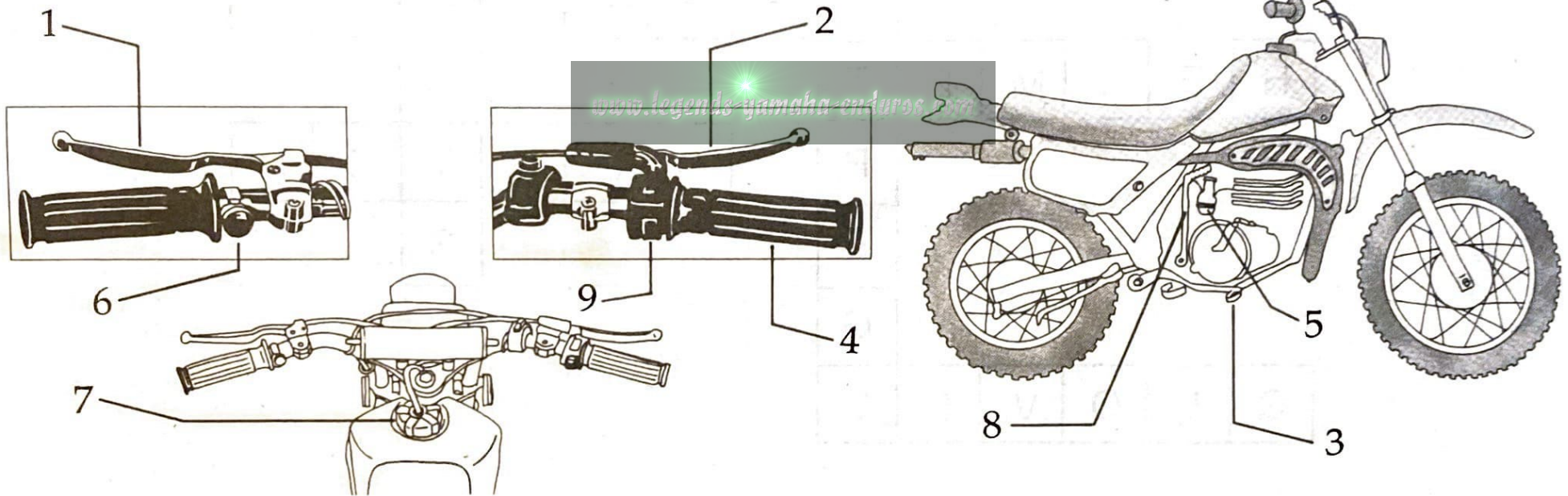

NOTES

www.legends-yamaha-enduros.com

NOTES

www.legends-yamaha-enduros.com

www.legends-yamaha-enduros.com

Motorcycle Safety Foundation

2 Jenner, Suite 150
Irvine, CA 92618-3806
Phone: 949.727.3227
Fax: 949.727.4217
www.msf-usa.org



MSF
MOTORCYCLE
SAFETY FOUNDATION®

PN MSPU3444NC00

www.legends-yamaha-enduros.com



YAMAHA MOTOR CO., LTD.

PRINTED ON RECYCLED PAPER

PRINTED IN JAPAN
2008.04-1.0x1 CR
(E)